

BG60
-SKY-

YÜKSEK PERFORMANSLI
CEPHE IŞIKLIK SİSTEMİ
HIGH PERFORMANCE SKYLIGHT
CURTAIN WALL SYSTEM

1

*** TÜM AKSESUAR, DETAY VE MONTAJ TALİMATLARI İÇİN SİSTEMİN ANA KATALOĞUNU İSTEYİNİZ.**
PLEASE ASK FOR THE MAIN SYSTEM CATALOGUE FOR THE WHOLE ACCESSORIES, DETAILS AND FABRICATION MANUAL.

 **burak**
alüminyum

Her hakkı saklıdır; 2018. Burak Alüminyum'un izni olmadan kopya edilemez, çoğaltılamaz ve yayımlanamaz.
Copyright © 2018. All rights reserved. It shall not be reproduced without permission of Burak Aluminium.

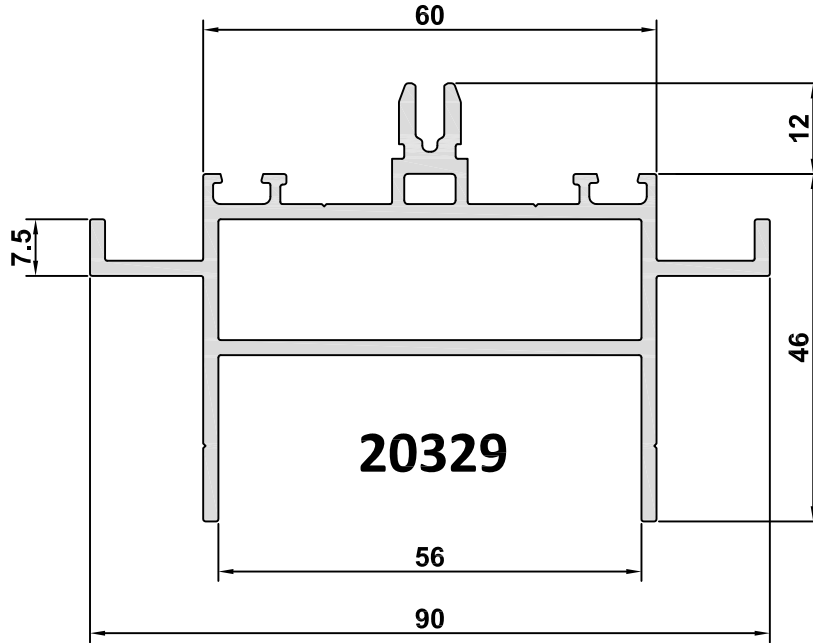
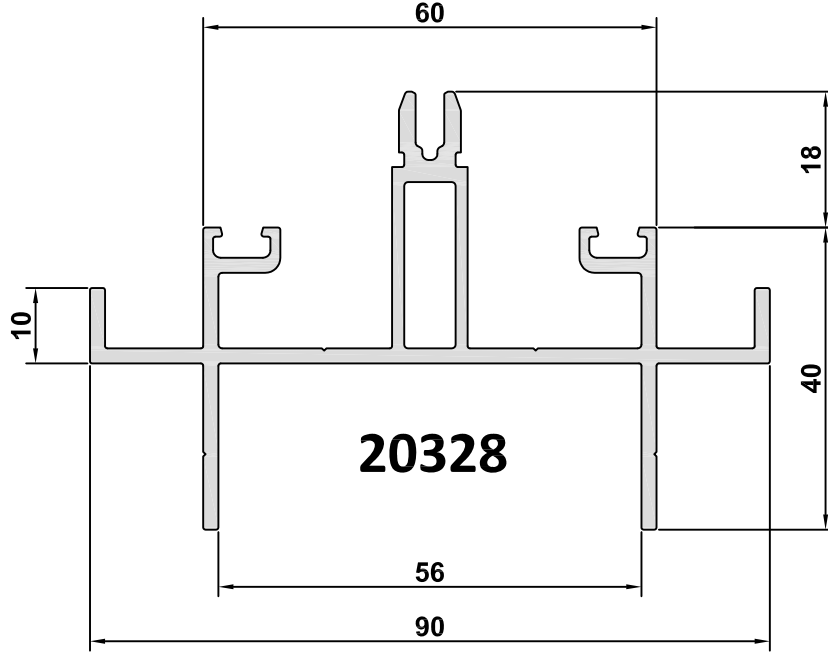

| PROFİL NUMARASI PROFILE NO. | AĞIRLIK WEIGHT (kg/m) |
|--------------------------------|--------------------------|
| 20328 | 1,469 |
| 20329 | 1,577 |

| PROFİL NUMARASI PROFILE NO. | AĞIRLIK WEIGHT (kg/m) |
|--------------------------------|--------------------------|
| 20728 | 1,214 |
| BG6012 | 1,998 |
| 20728 | 1,214 |
| BG6012 | 1,998 |
| BG6013 | 2,849 |
| 20109 | 0,383 |
| 20110 | 0,461 |

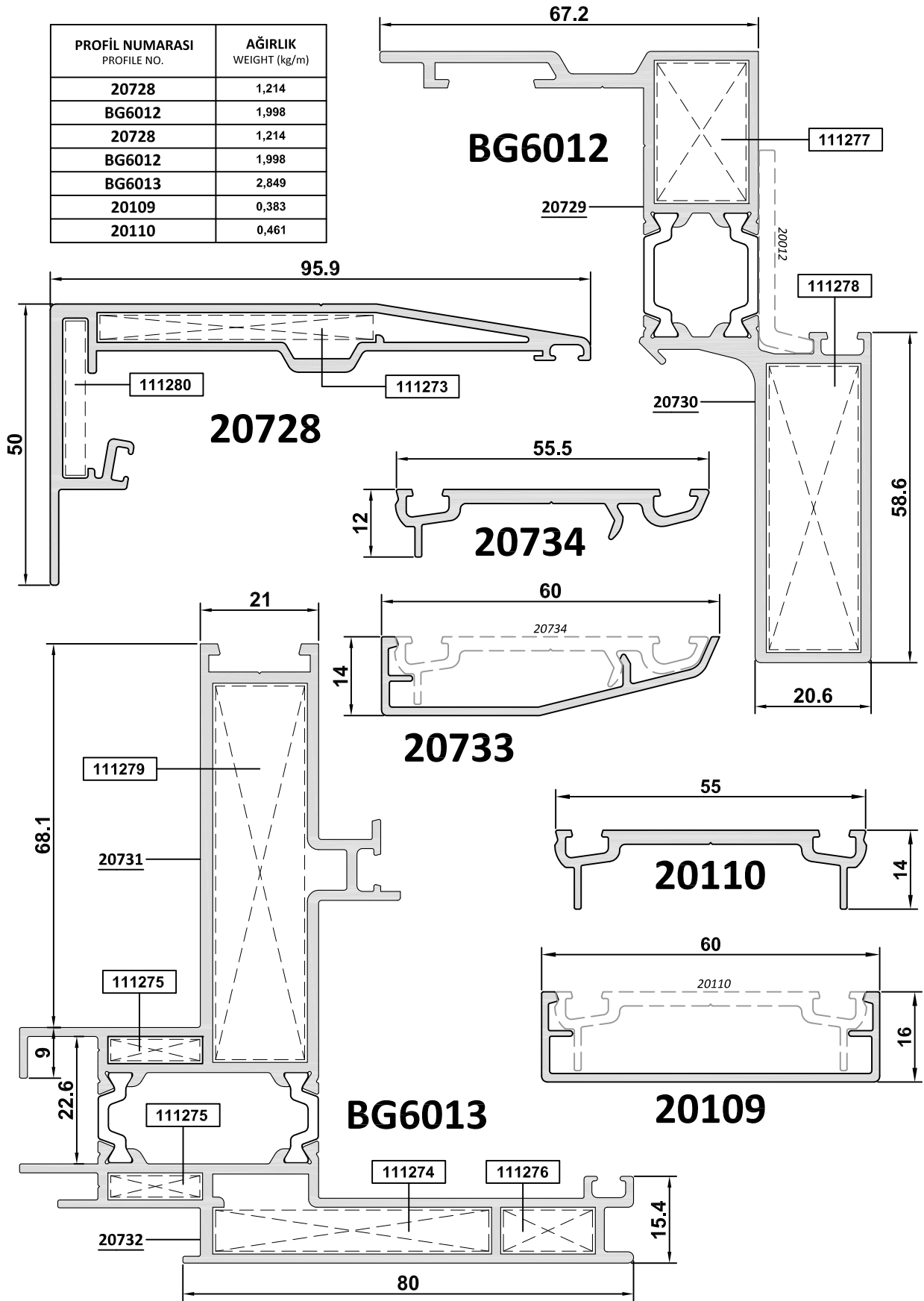

ALÜMİNYUM AKSESUAR PROFİLLERİ

PROFILES OF ALUMINIUM ACCESSORIES

| PROFİL NUMARASI PROFILE NO. | AĞIRLIK WEIGHT (kg/m) |
|--------------------------------|--------------------------|
| 20012 | 0,313 |
| 20301 | 2,564 |
| 5580-49 | 5,427 |
| 21253-40 | 1,257 |

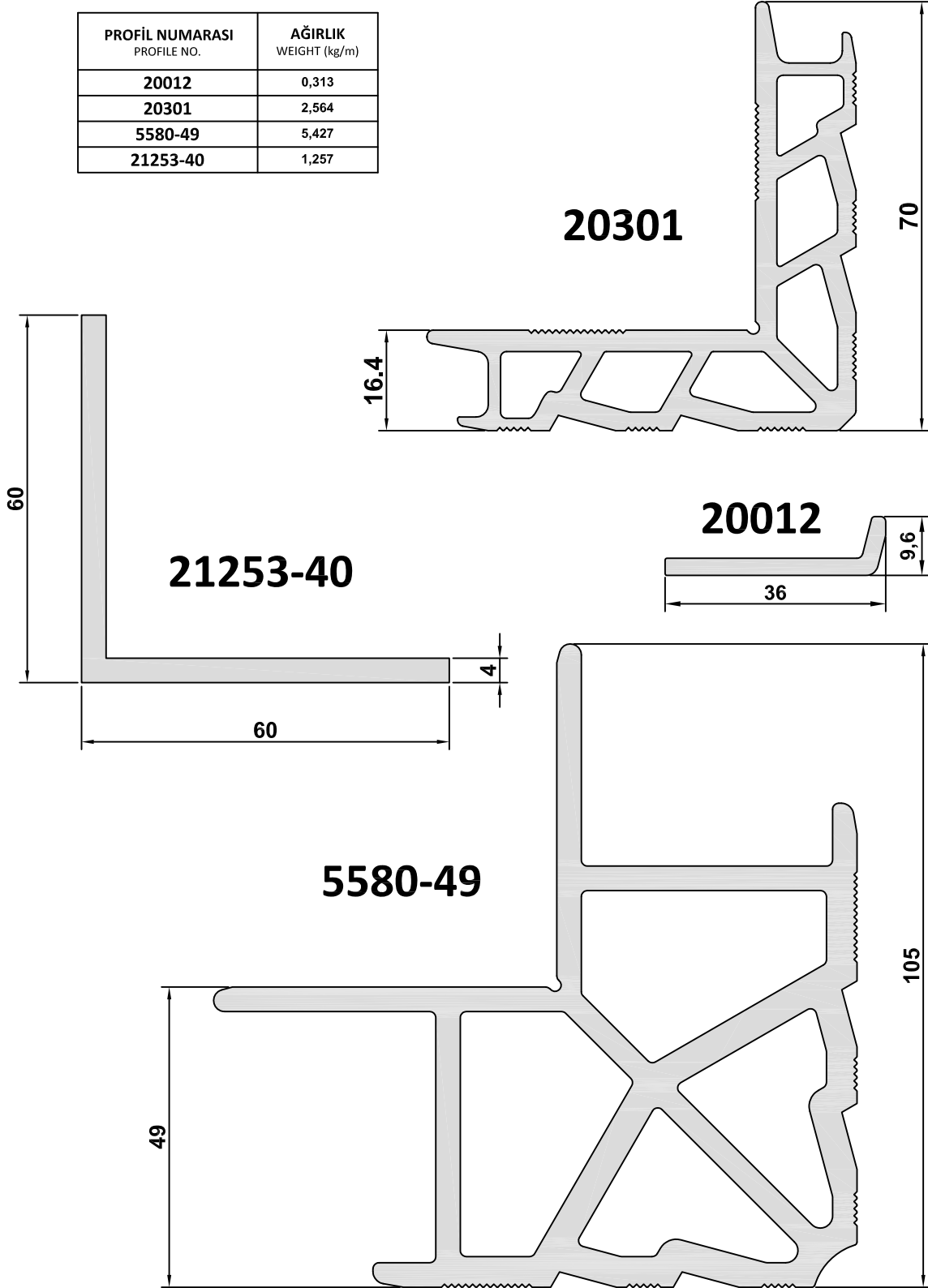

4













| KÖŞE TAKOZLARI / CORNER CLEATS | | |
|---|--|----------------------------------|
| ÇİZİM / DRAWING | AKSESUAR KODU VE ÜRÜN BİLGİLERİ / ACCESSORY CODE AND PRODUCT DESCRIPTION | KESİM ÖLÇÜSÜ / CUTTING DIMENSION |
|  | 111273 PROFİL NUMARASI / PROFILE NUMBER: 5580-49 PROFİL AĞIRLIĞI / PROFILE WEIGHT: 5,427 kg/m | 5 mm |
|  | 111274 PROFİL NUMARASI / PROFILE NUMBER: 5580-49 PROFİL AĞIRLIĞI / PROFILE WEIGHT: 5,427 kg/m | 8 mm |
|  | 111275 PROFİL NUMARASI / PROFILE NUMBER: 20301 PROFİL AĞIRLIĞI / PROFILE WEIGHT: 2,564 kg/m | 4,5 mm |
|  | 111276 PROFİL NUMARASI / PROFILE NUMBER: 20301 PROFİL AĞIRLIĞI / PROFILE WEIGHT: 2,564 kg/m | 8 mm |
|  | 111277 PROFİL NUMARASI / PROFILE NUMBER: 20301 PROFİL AĞIRLIĞI / PROFILE WEIGHT: 2,564 kg/m | 25 mm |
|  | 111278 PROFİL NUMARASI / PROFILE NUMBER: 20301 PROFİL AĞIRLIĞI / PROFILE WEIGHT: 2,564 kg/m | 51 mm |
|  | 111279 PROFİL NUMARASI / PROFILE NUMBER: 20301 PROFİL AĞIRLIĞI / PROFILE WEIGHT: 2,564 kg/m | 66,8 mm |
|  | 111280 PROFİL NUMARASI / PROFILE NUMBER: 21253-40 PROFİL AĞIRLIĞI / PROFILE WEIGHT: 1,257 kg/m. | 28 mm |

5

DETAYLAR

DETAILS

TARAMA STİLLERİ / HATCH STYLES

- | | | | |
|---|---|---|--|
|  | EPDM FİTİL / EPDM GASKET |  | PVC PROFİL / PVC PROFILE |
|  | STRÜKTÜREL SİLİKON / STRUCTURAL SILICONE |  | ÇELİK PROFİL / STEEL PROFILE |
|  | MESAFE BELİRLEYİCİ / SPACE ADJUSTER |  | SU YALITIM MEMBRANI / WATERPROOFING MEMBRANE |
|  | ALÜMİNYUM PROFİL / ALUMINIUM PROFILE |  | POLİETİLEN CONTA / POLYETHYLENE GASKET |
|  | PROFİL PARÇA (Al) / PIECE OF PROFILE (Al) |  | TAŞYÜNÜ / ROCKWOOL |
|  | ISI BARIYERİ / INSULATION BAR |  | CAM / GLASS |

KAPAKLI CEPHEDE IŞIKLIK DÜŞEY DETAYI CAPPED SKYLIGHT CURTAIN WALL VERTICAL DETAIL

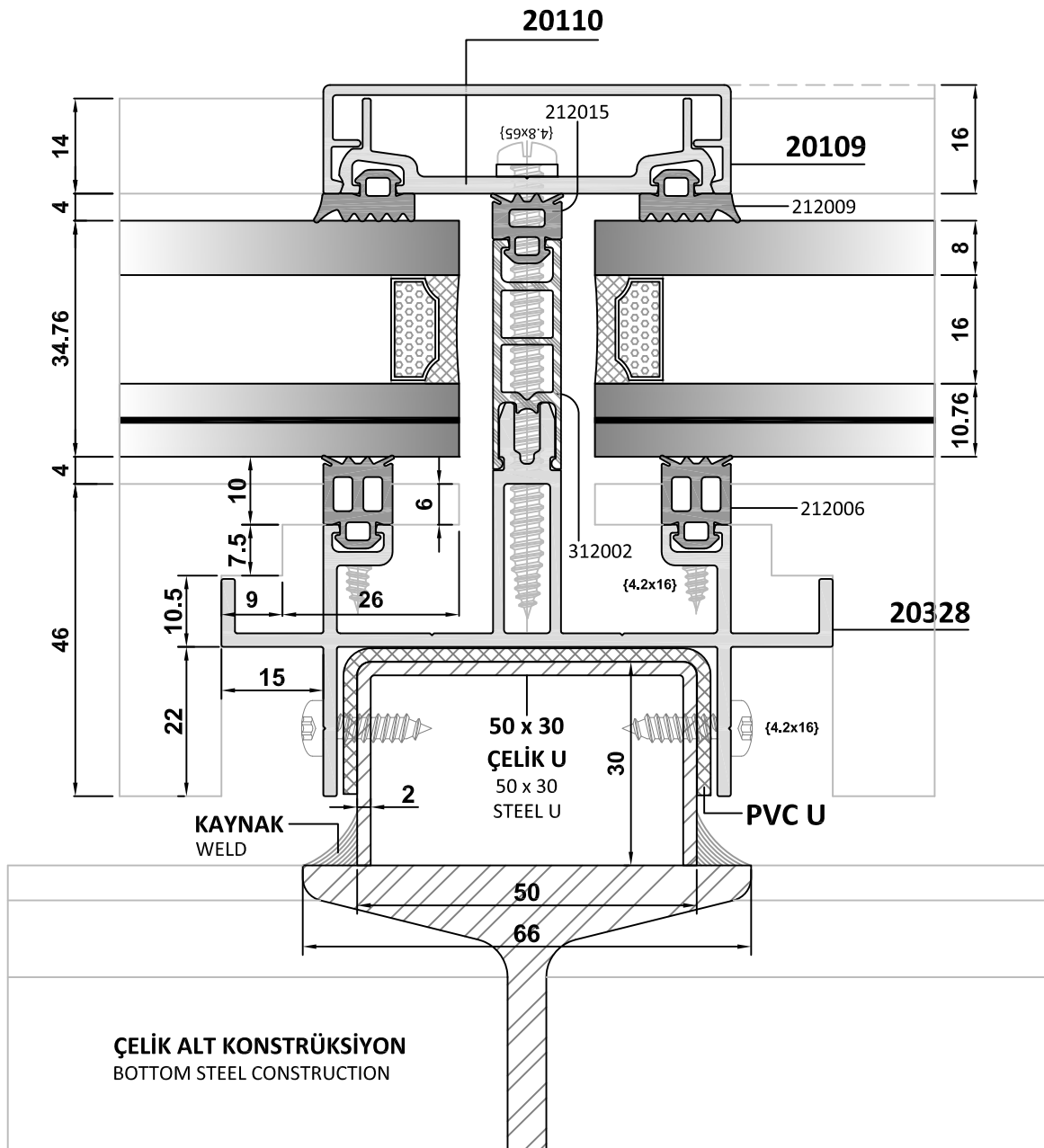
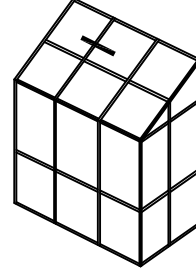

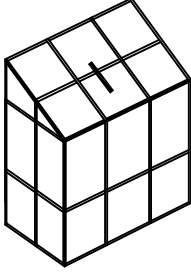

KAPAKLI CEPHEDE İŞIKLIK YATAY DETAYI
CAPPED SKYLIGHT CURTAIN WALL HORIZONTAL DETAIL

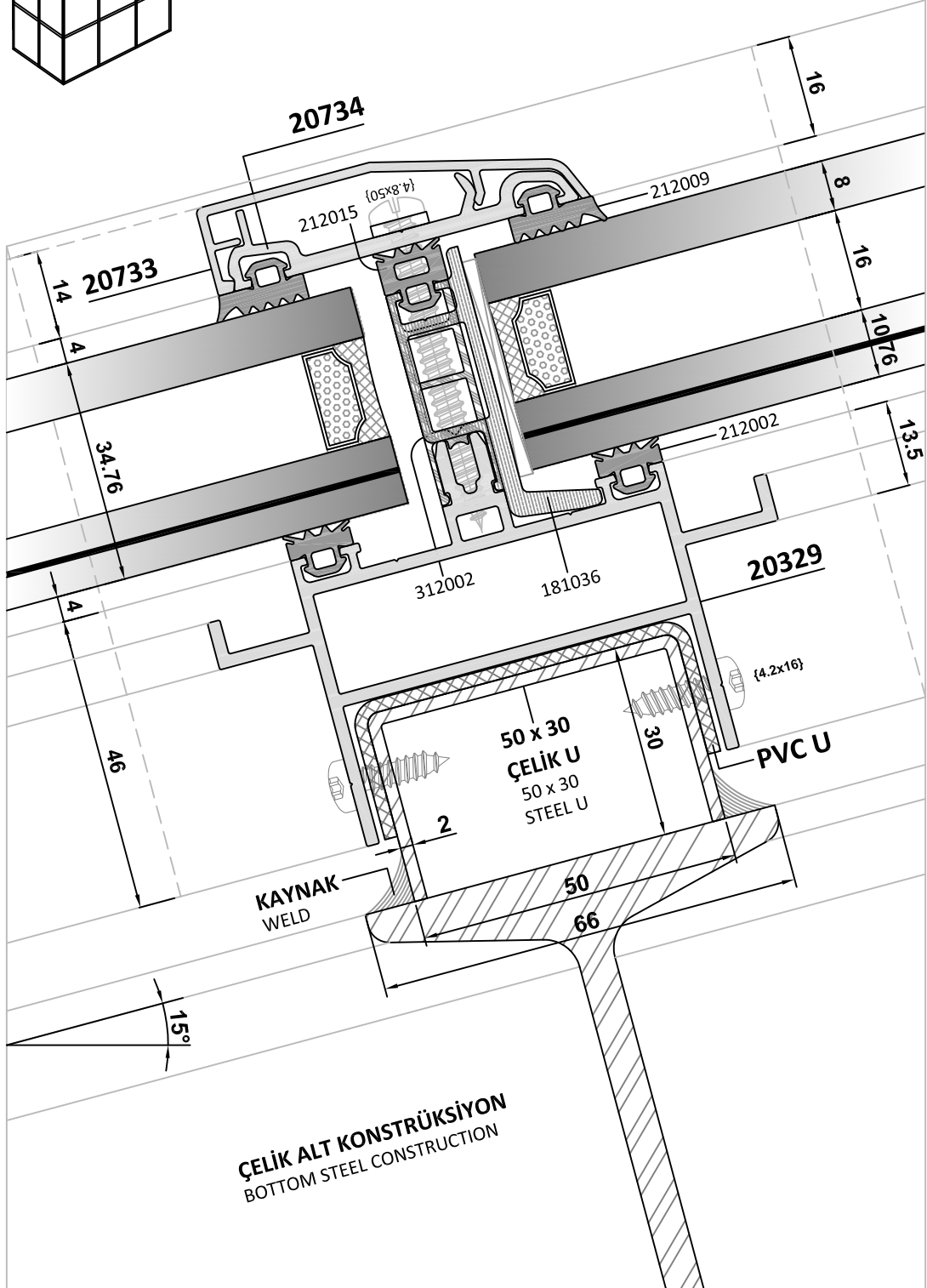

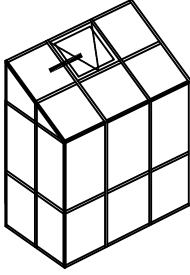

KAPAKLI CEPHEDE DIŐA AÇILIR KANAT DÜŐEY DETAYI OPENING VENT VERTICAL DETAIL IN CAPPED SKYLIGHT CURTAIN WALL

ÖLÇEK / SCALE: $\frac{4}{5}$

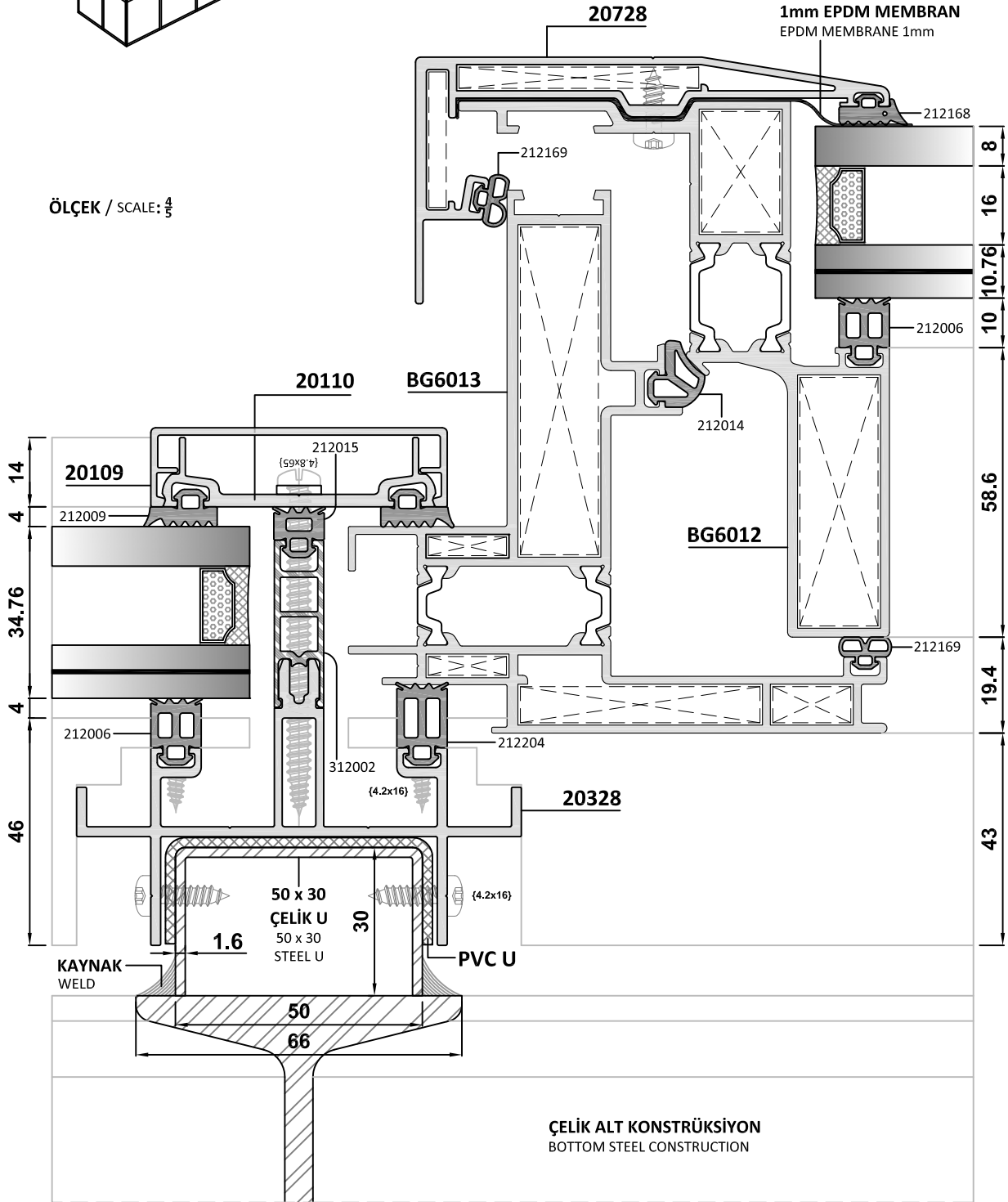

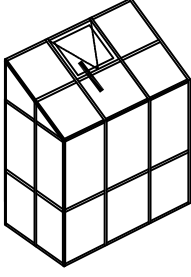

KAPAKLI CEPHEDE DIŐA AÇILIR KANAT YATAY DETAYI

OPENING VENT HORIZONTAL
DETAIL IN CAPPED SKYLIGHT
CURTAIN WALL

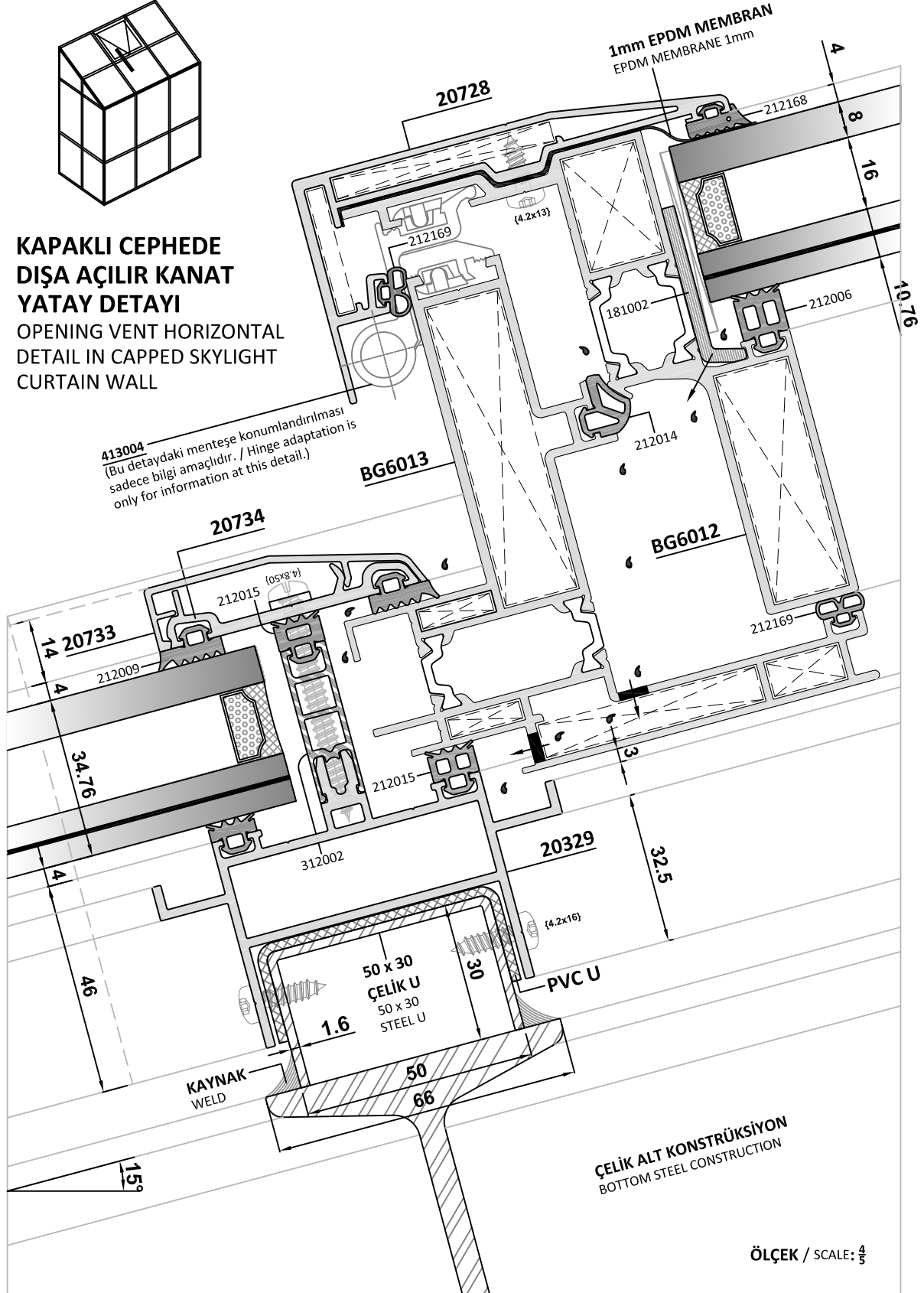

10

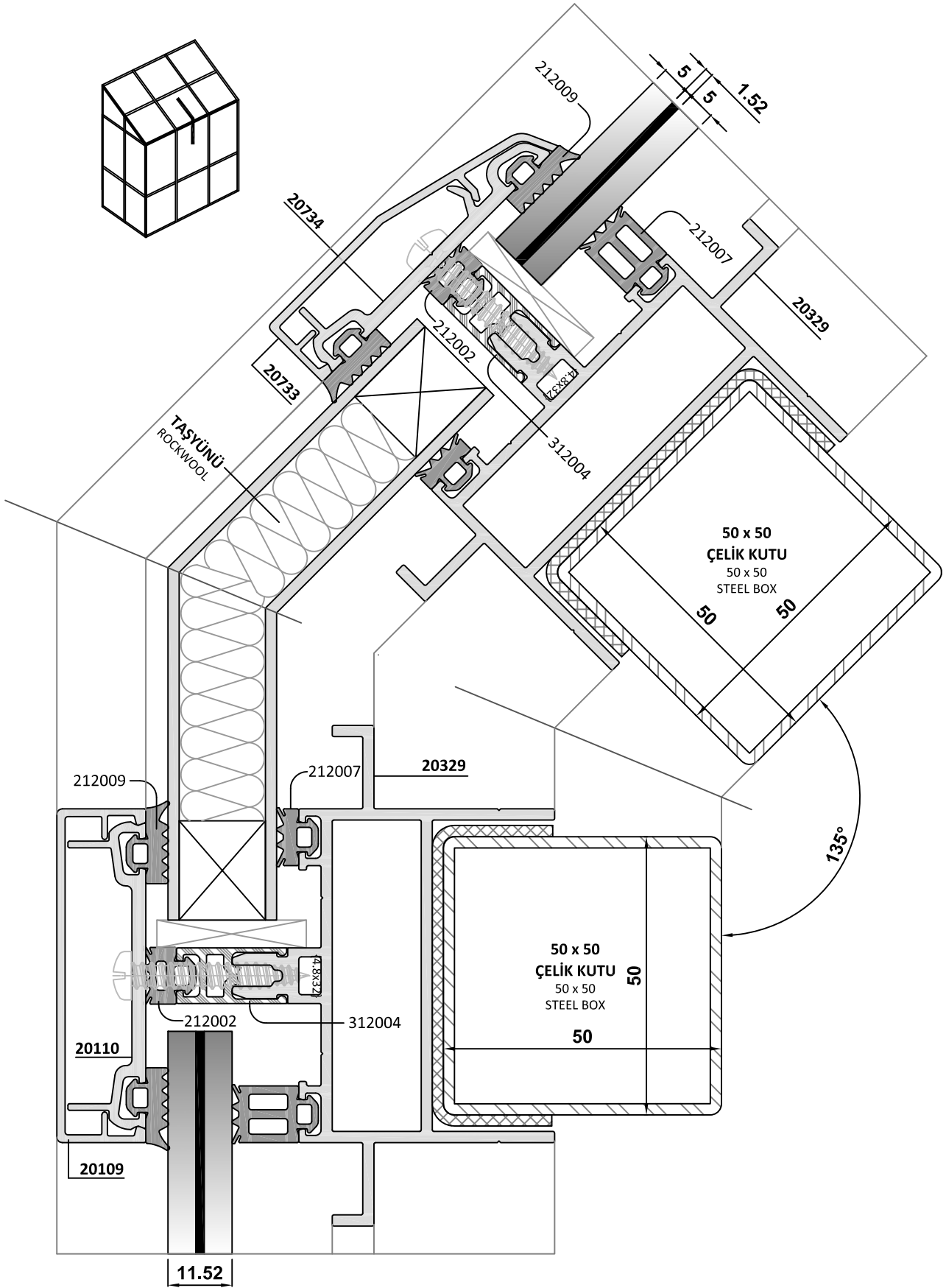

CAM CEPHE IŞIKLIK DÜŞEY DETAYI
FOURSIDED SKYLIGHT CURTAIN WALL VERTICAL DETAIL

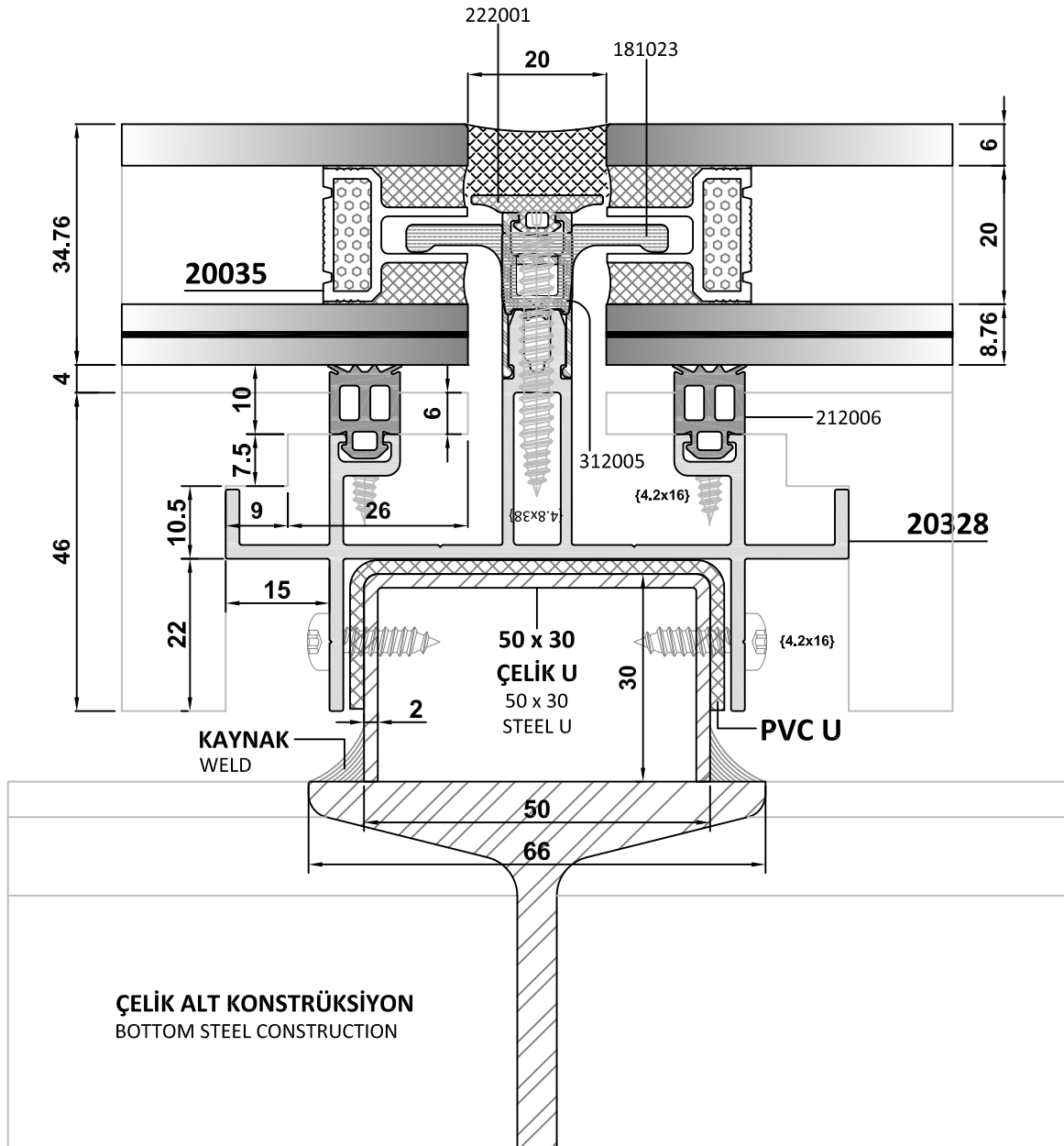
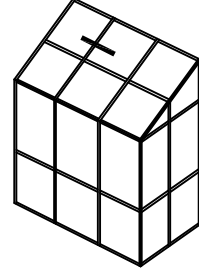

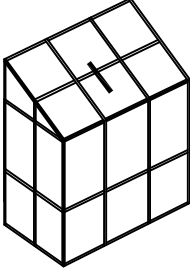

CAM CEPHEDE İŞIKLIK YATAY DETAYI CAPPED SKYLIGHT CURTAIN WALL HORIZONTAL DETAIL

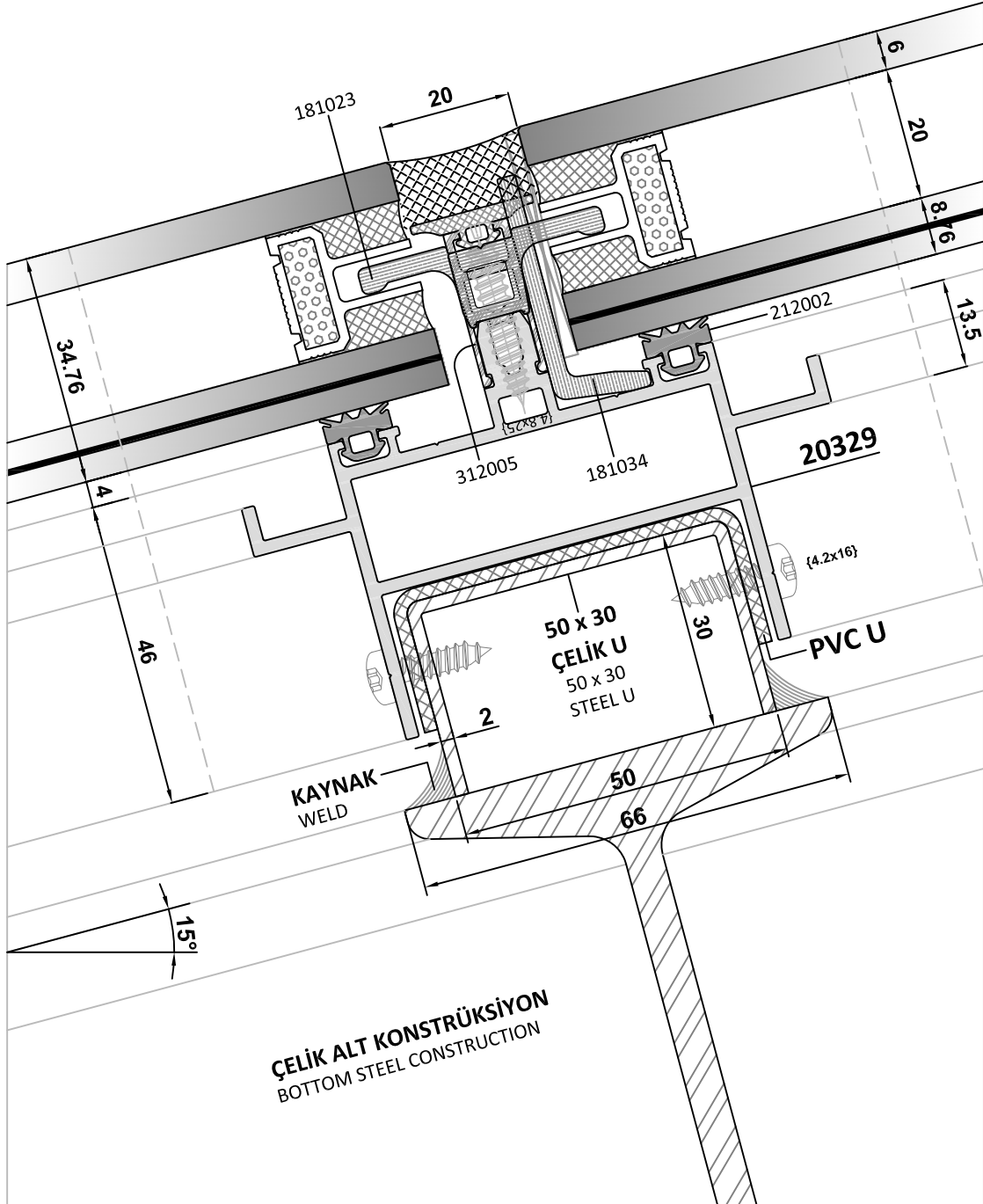

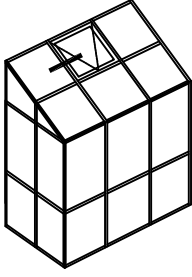

CAM CEPHEDE DIŐA AÇILIR KANAT DÜŐEY DETAYI

OPENING VENT VERTICAL DETAIL IN FOURSIDED SKYLIGHT C. WALL

ÖLÇEK / SCALE: $\frac{4}{5}$

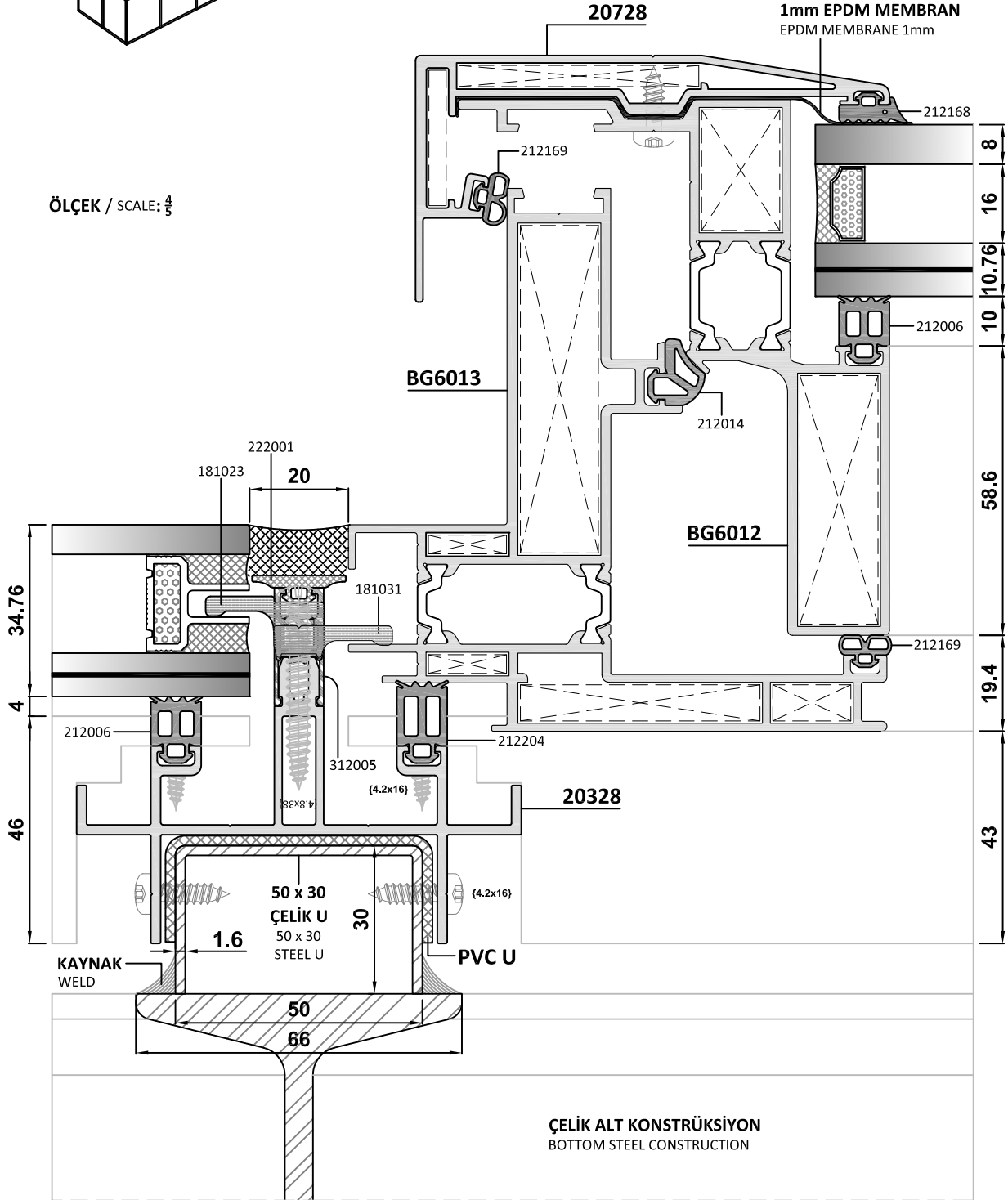

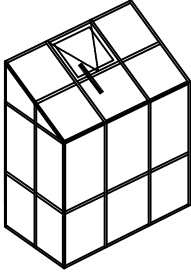

**CAM CEPHEDE
DIŐA AÇILIR KANAT
YATAY DETAYI**
OPENING VENT HORIZONTAL
DETAIL IN FOURSIDED SKYLIGHT
CURTAIN WALL

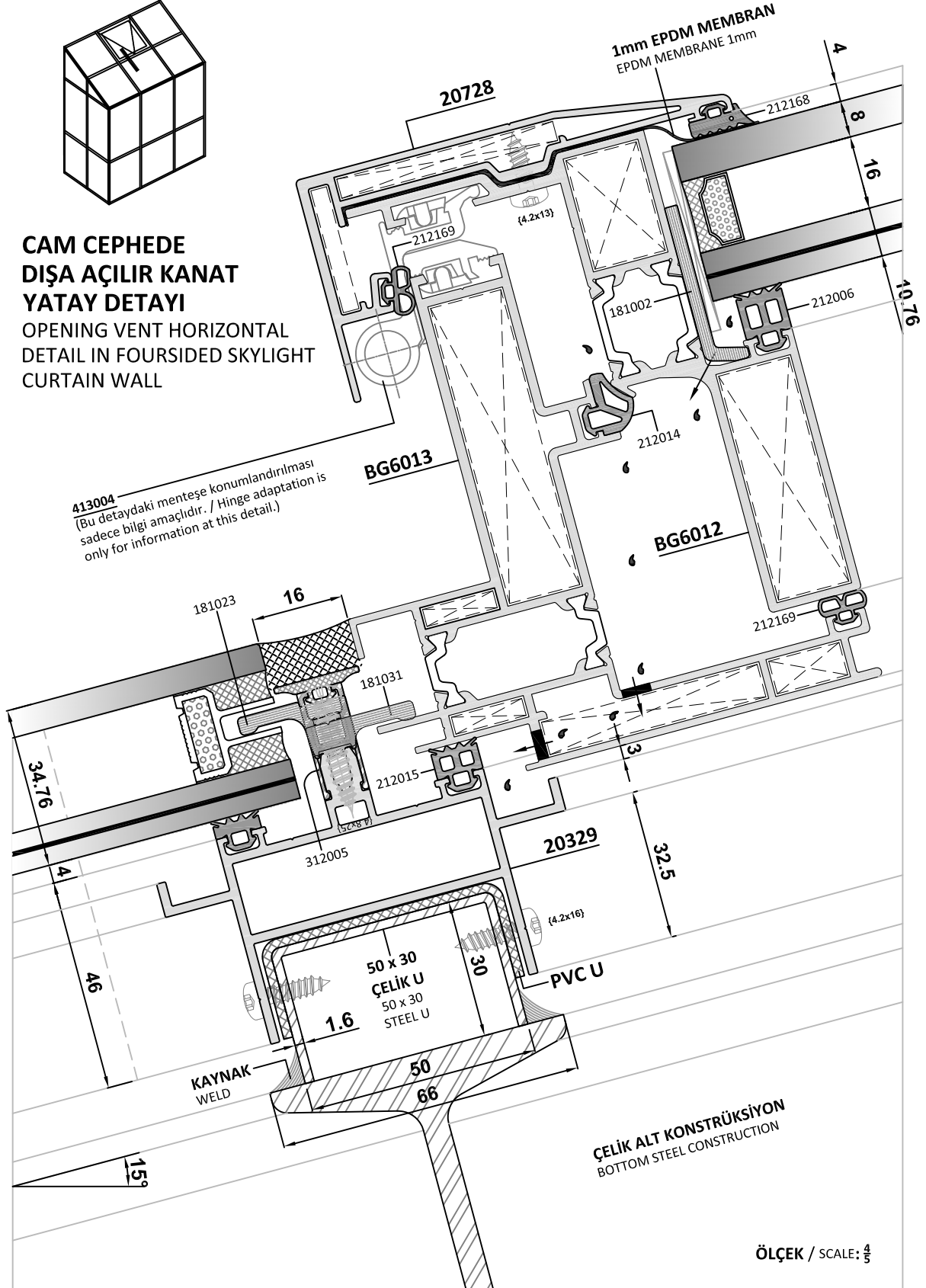

YARI KAPAKLI CEPHEDE İŞIKLIK DÜŞEY DETAYI
TWO SIDED SKYLIGHT CURTAIN WALL VERTICAL DETAIL

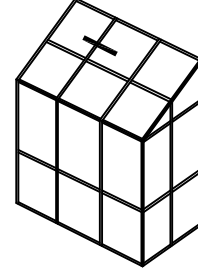

Düşey: Kapaklı
Yatay: Silikon

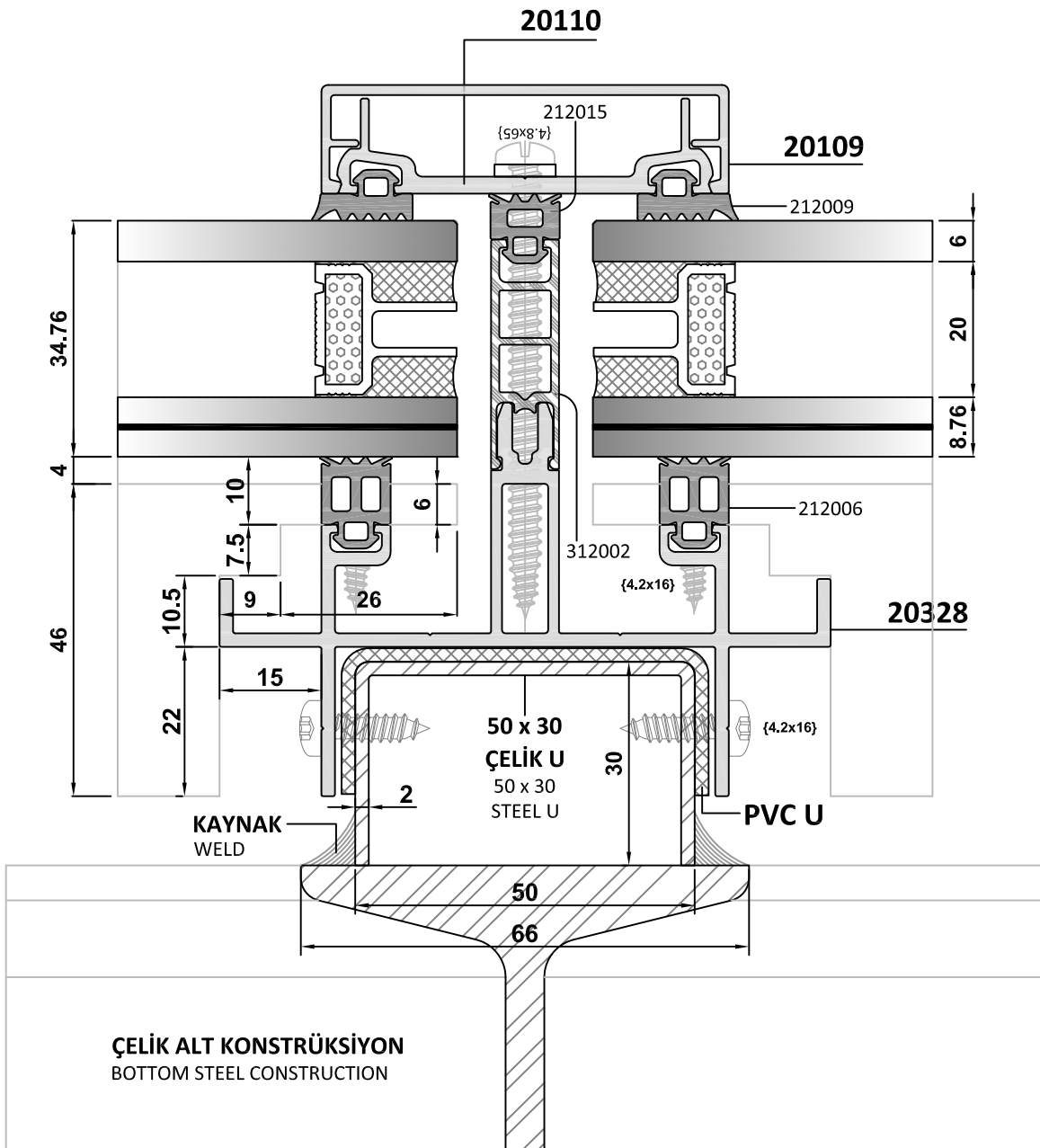

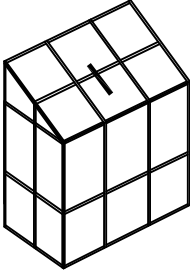

YARI KAPAKLI CEPHEDE IŞIKLIK YATAY DETAYI TWO SIDED SKYLIGHT CURTAIN WALL HORIZONTAL DETAIL

Düsey: Kapaklı
Yatay: Silikon

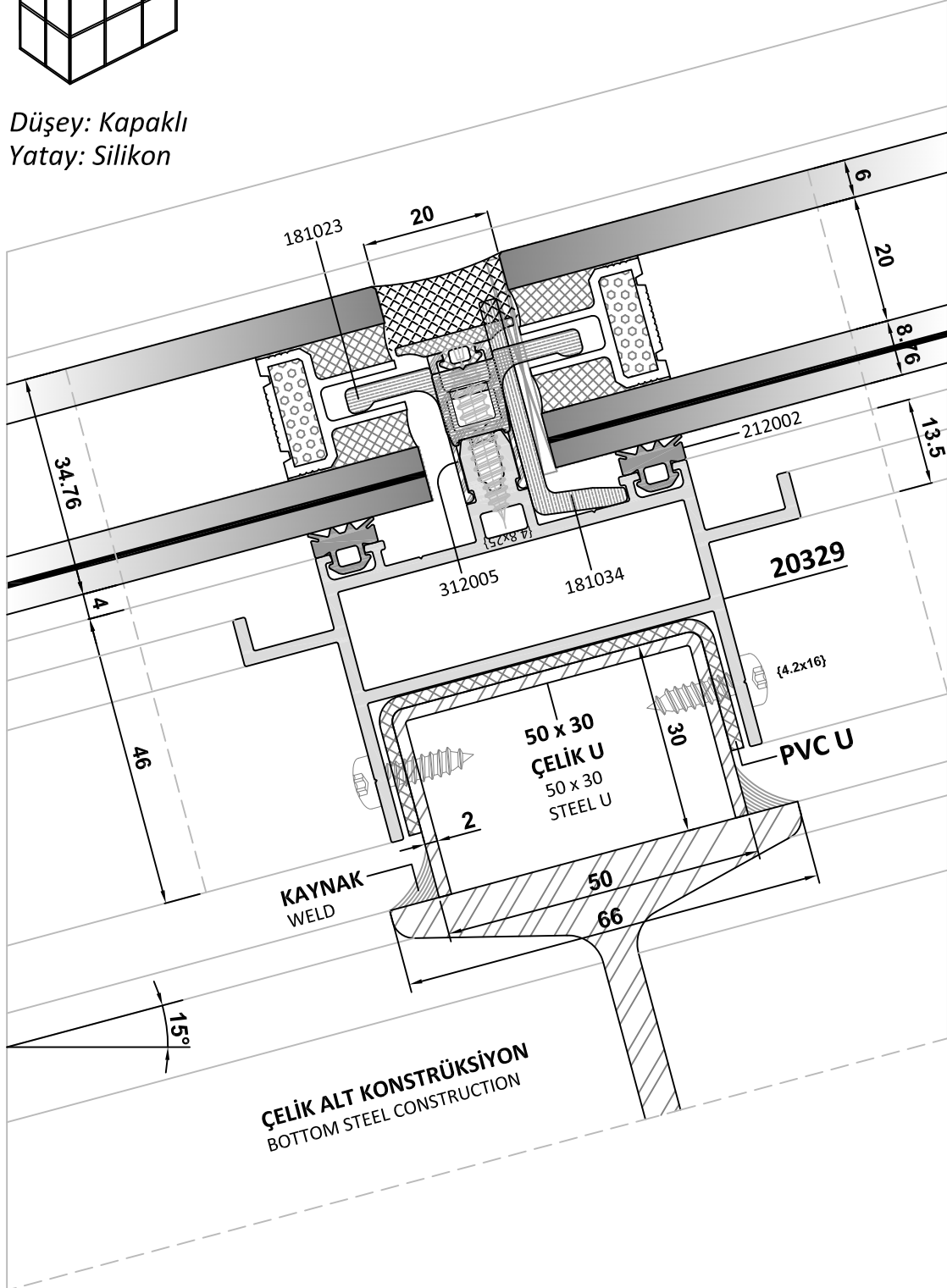

17