

# BAĞLANTI PROFİLLERİ CONNECTION PROFILES

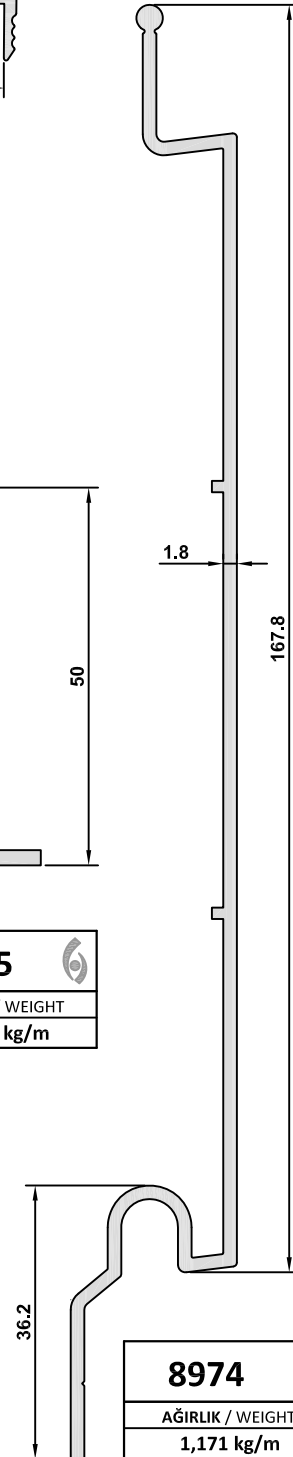

BAĞLANTI / CONNECTION

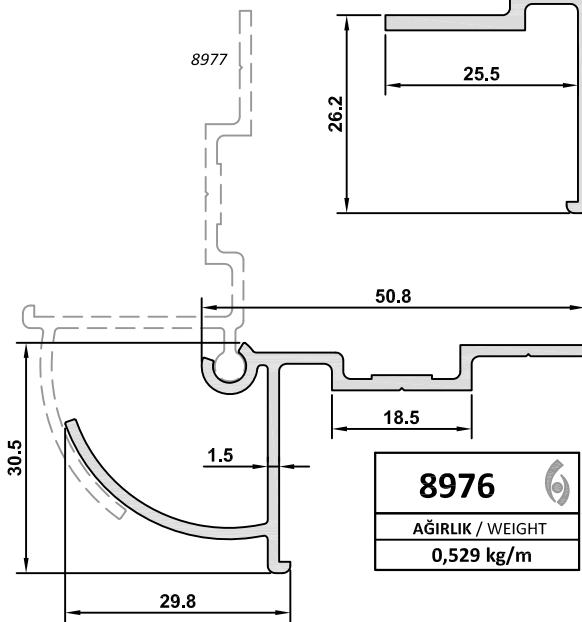
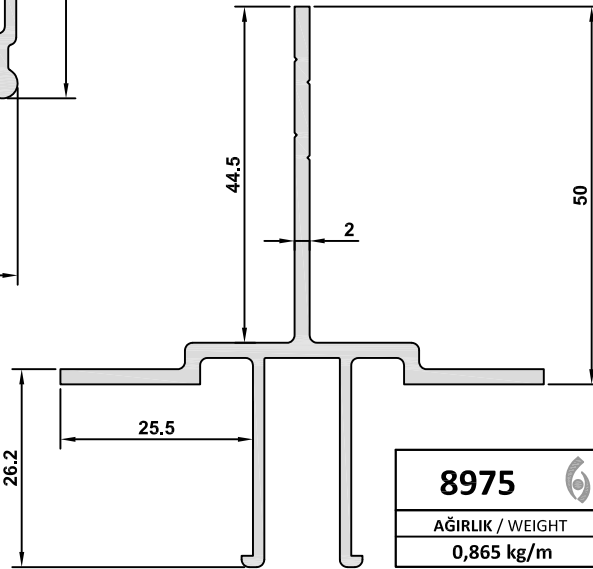
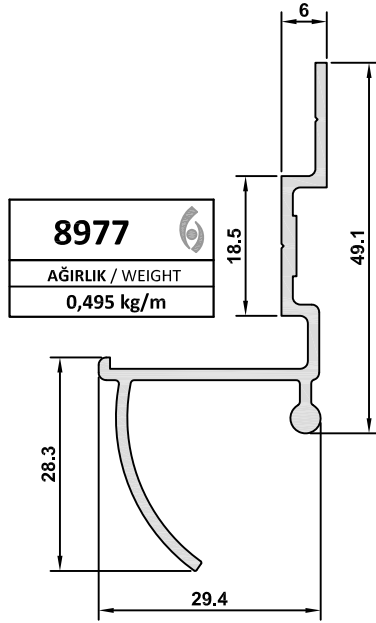
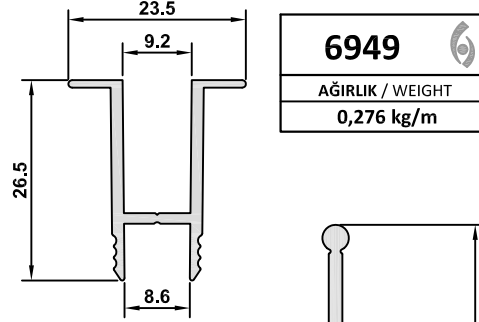
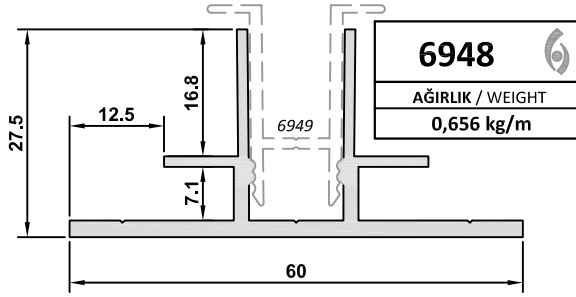
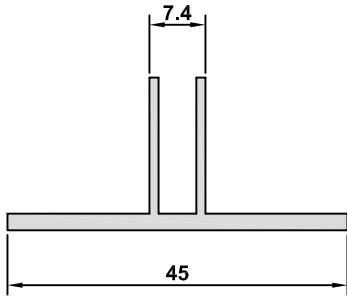

**4795**  
AĞIRLIK / WEIGHT  
0,384 kg/m

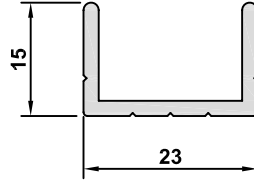

**4445**  
AĞIRLIK / WEIGHT  
0,260 kg/m

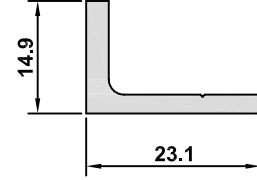

**4793**  
AĞIRLIK / WEIGHT  
0,257 kg/m

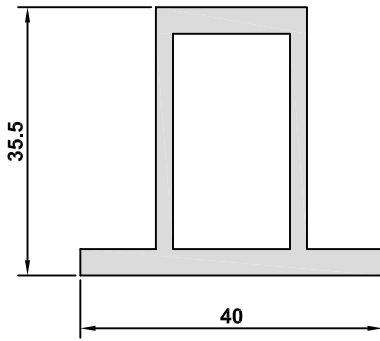

**4635**  
AĞIRLIK / WEIGHT  
0,920 kg/m

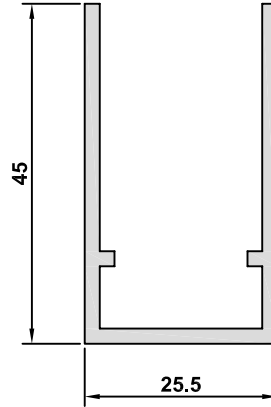

**4461**  
AĞIRLIK / WEIGHT  
0,625 kg/m

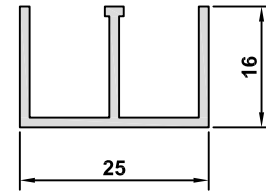

**2022-13**  
AĞIRLIK / WEIGHT  
0,286 kg/m

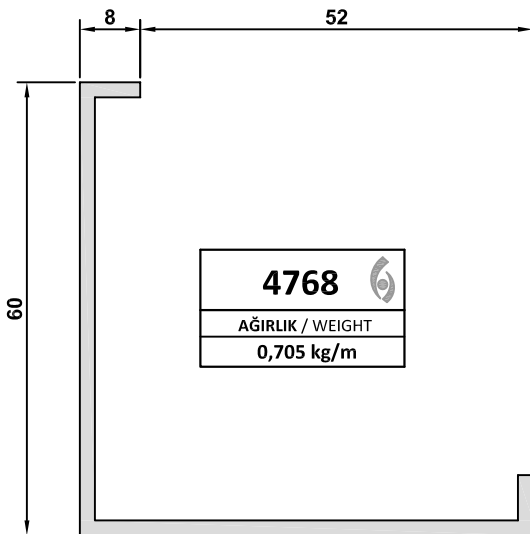

**4768**  
AĞIRLIK / WEIGHT  
0,705 kg/m

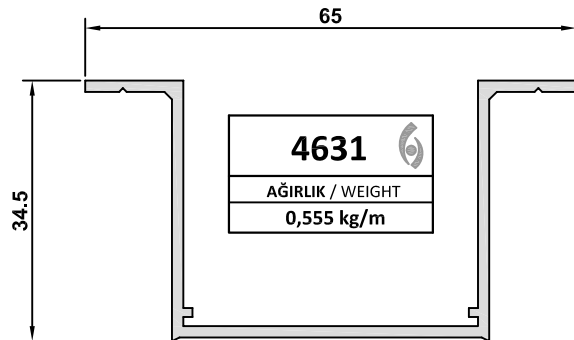

**4631**  
AĞIRLIK / WEIGHT  
0,555 kg/m

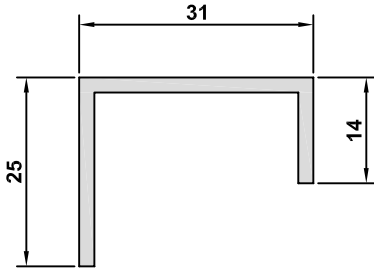

<b>5230-2.0</b>
AĞIRLIK / WEIGHT
0358 kg/m

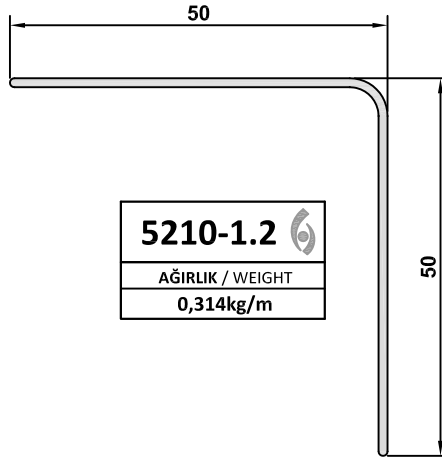

<b>5210-1.2</b>
AĞIRLIK / WEIGHT
0,314kg/m

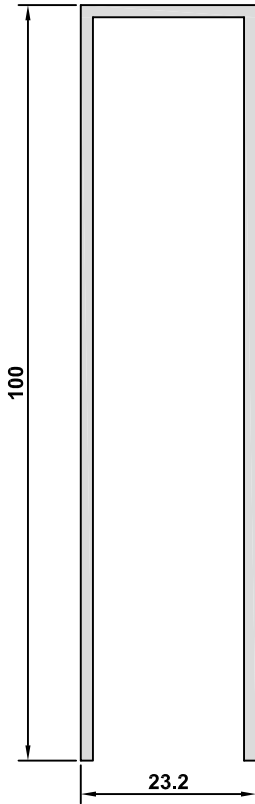

<b>4733</b>
AĞIRLIK / WEIGHT
0,950 kg/m

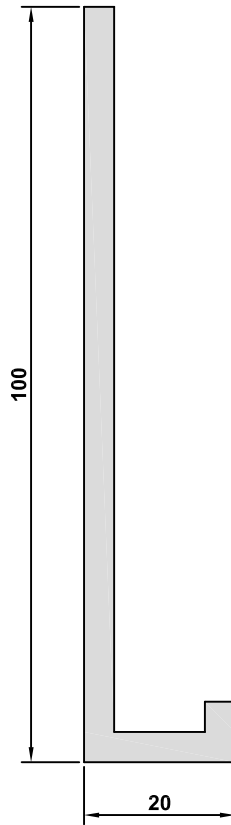

<b>3085</b>
AĞIRLIK / WEIGHT
1,301 kg/m

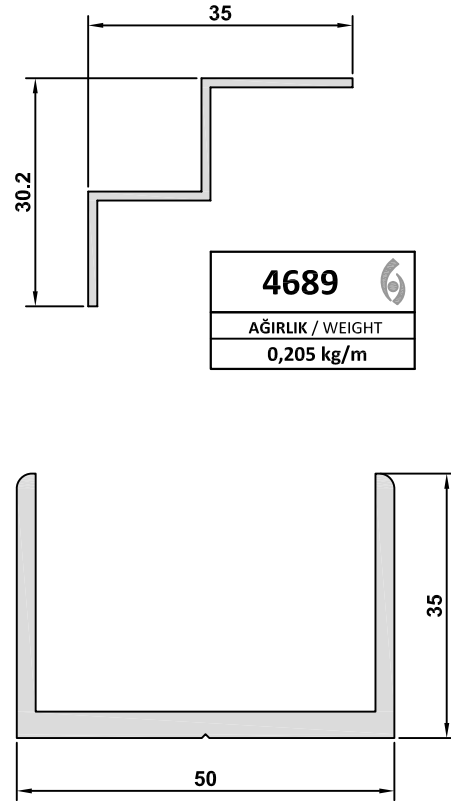

<b>4689</b>
AĞIRLIK / WEIGHT
0,205 kg/m

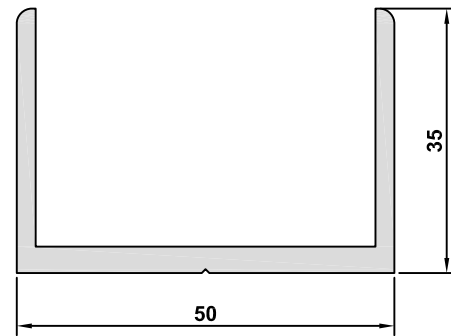

<b>4149-00</b>
AĞIRLIK / WEIGHT
0,894 kg/m

BAĞLANTI / CONNECTION

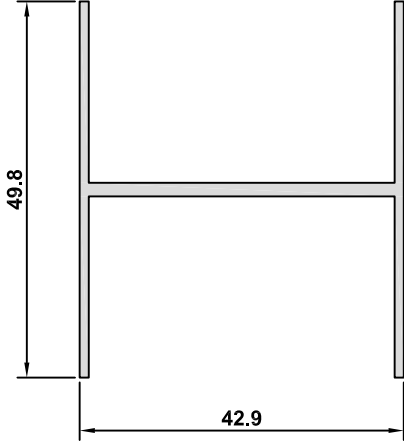

**3092-12**  
AĞIRLIK / WEIGHT  
0,520 kg/m

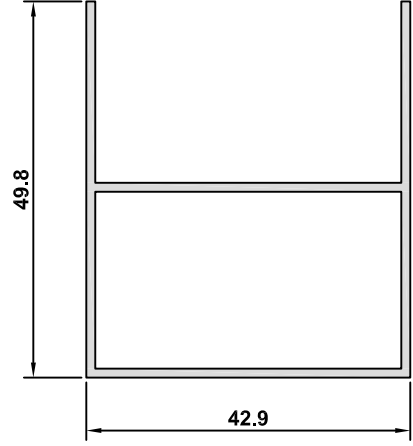

**3091-12**  
AĞIRLIK / WEIGHT  
0,610 kg/m

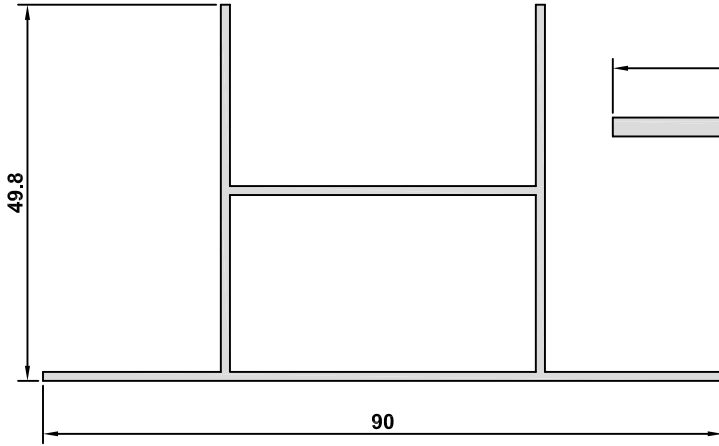

**4874-12**  
AĞIRLIK / WEIGHT  
0,745 kg/m

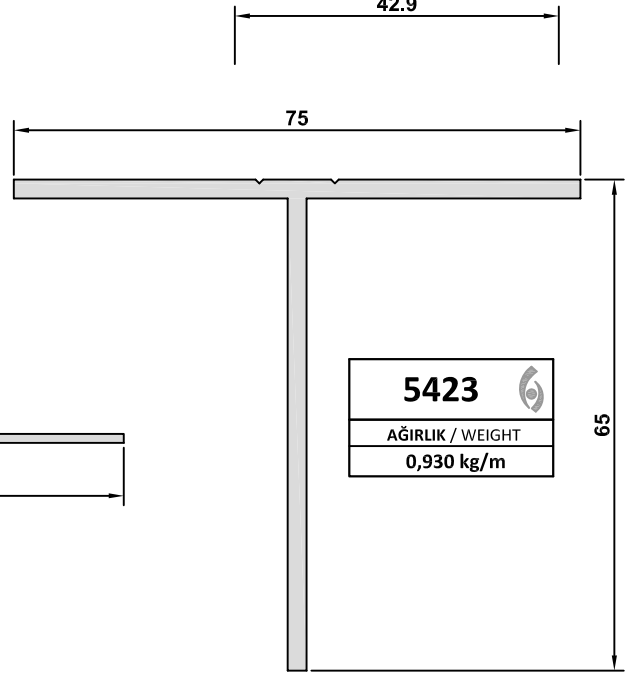

**5423**  
AĞIRLIK / WEIGHT  
0,930 kg/m

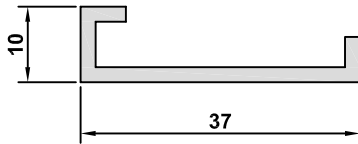

**4739-2.0**  
AĞIRLIK / WEIGHT  
0,287 kg/m

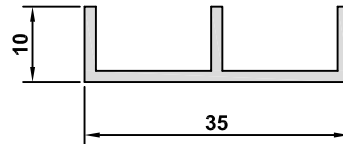

**5058-1.5**  
AĞIRLIK / WEIGHT  
0,805 kg/m

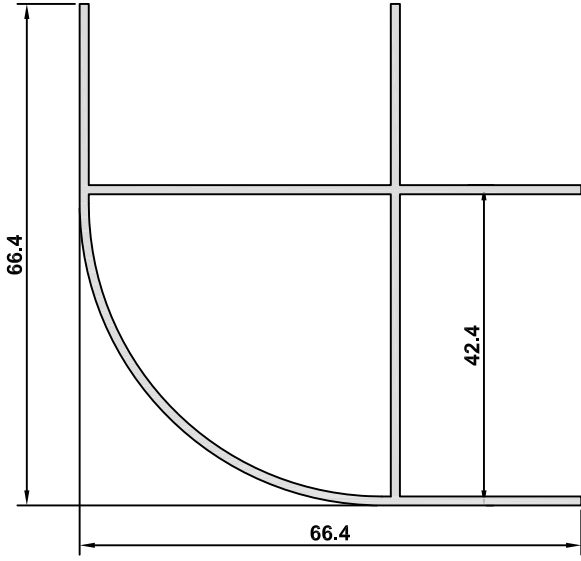

<b>3090-12</b>
AĞIRLIK / WEIGHT
0,820 kg/m

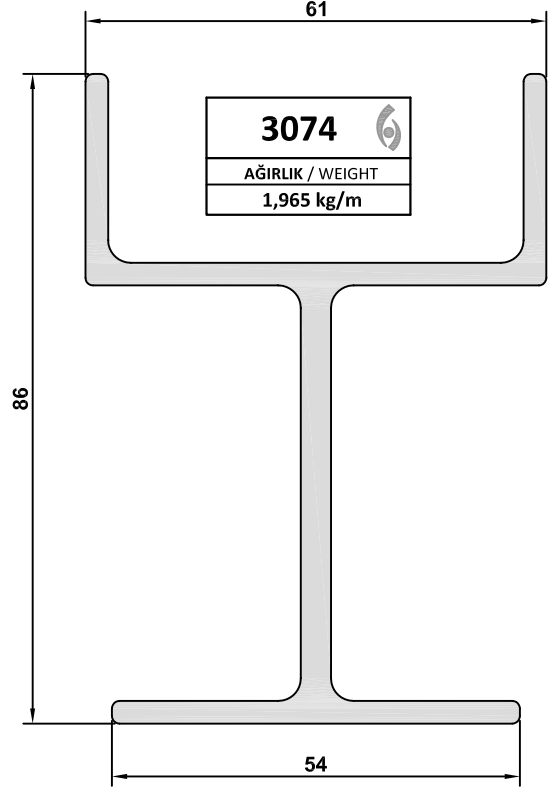

<b>3074</b>
AĞIRLIK / WEIGHT
1,965 kg/m

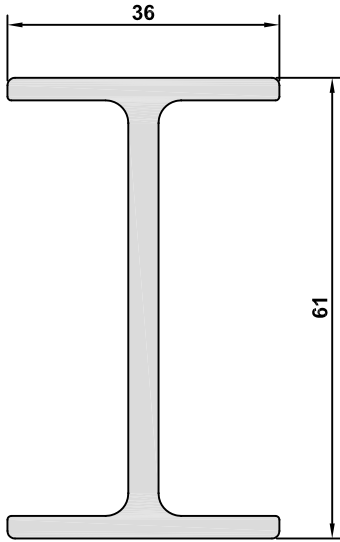

<b>3071</b>
AĞIRLIK / WEIGHT
1,201 kg/m

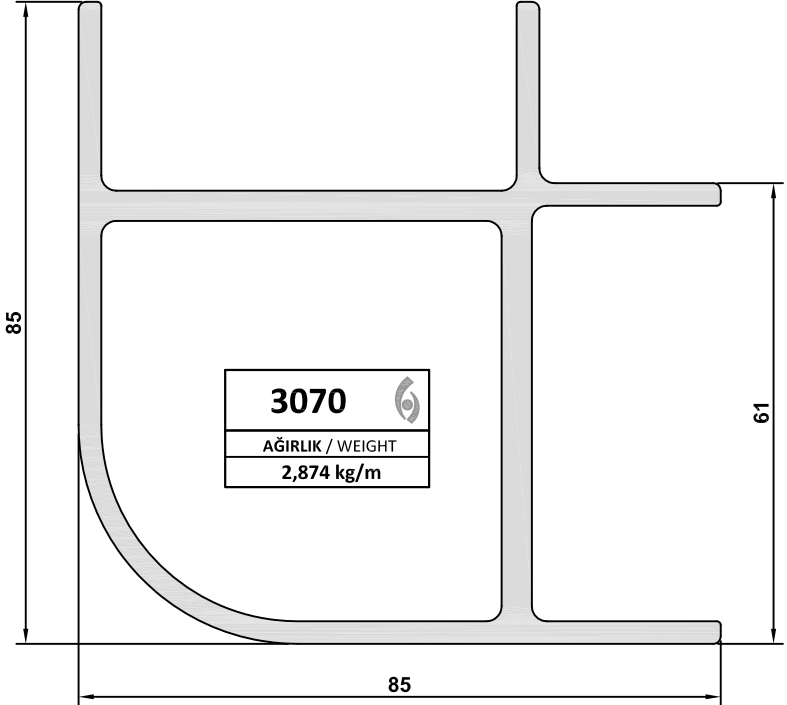

<b>3070</b>
AĞIRLIK / WEIGHT
2,874 kg/m

BAĞLANTI / CONNECTION

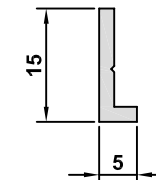
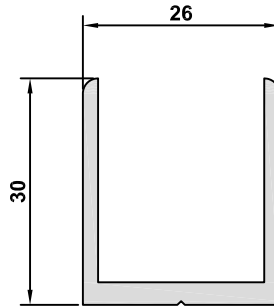
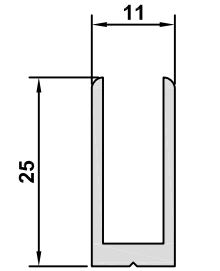
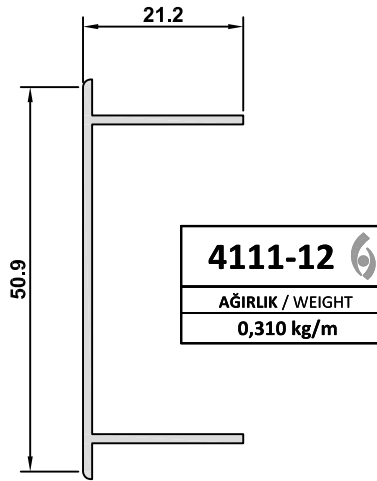
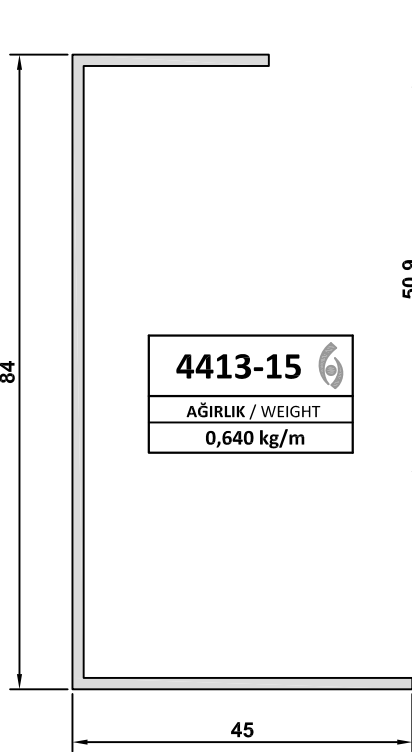
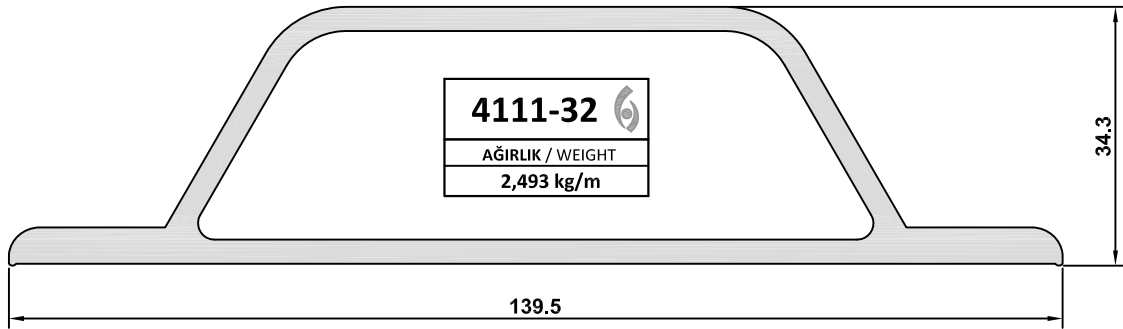
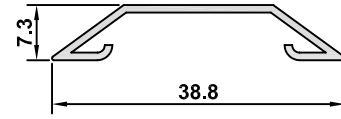
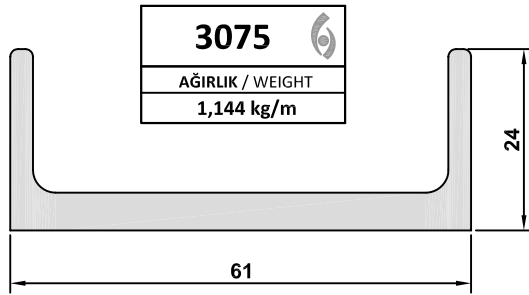

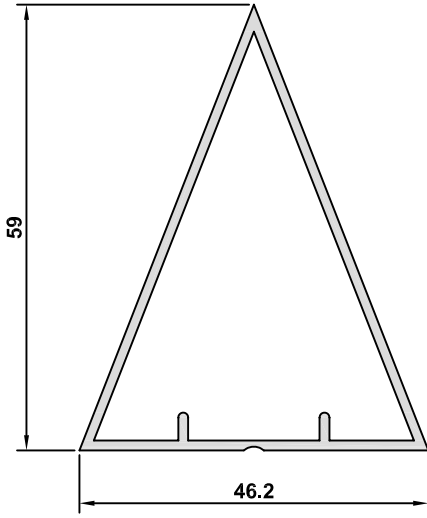

<b>4200</b>	
AĞIRLIK / WEIGHT	
0,607 kg/m	

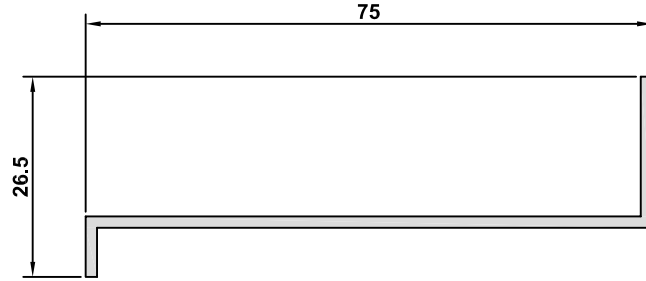

<b>5922</b>	
AĞIRLIK / WEIGHT	
0,407 kg/m	

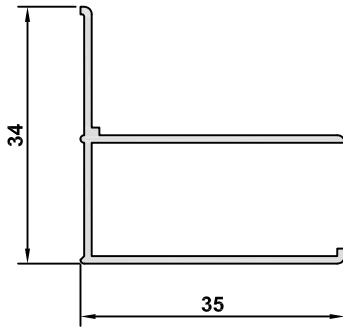

<b>2556-12</b>	
AĞIRLIK / WEIGHT	
0,282 kg/m	

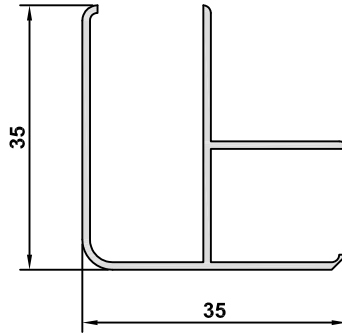

<b>2557-00</b>	
AĞIRLIK / WEIGHT	
0,320 kg/m	

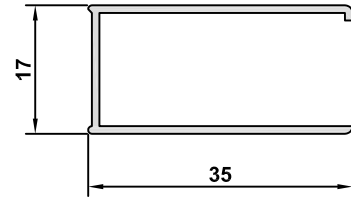

<b>2555-12</b>	
AĞIRLIK / WEIGHT	
0,230 kg/m	