



BM 55

**Ekonomik Kapı ve
Pencere Sistemi**

**Economical Windows &
Door System**

- **Sistem Katalođu**

Teknik Özellikler

Profil Bilgisi

Sistem Detayları

Aksesuarlar

Montaj Talimatları

- **System Catalogue**

Technical Properties

Profile Data

System Details

Accessories

Fabrication Manual

İÇİNDEKİLER / INDEX

TEKNİK ÖZELLİKLER / TECHNICAL PROPERTIES	: 2 , 3
TERMAL HESAP SONUÇLARI / THERMAL CALCULATION RESULT	: 4 , 5 , 6
PROFİL FİHRİSTİ / PROFILE INDEX	: 7 ... 16
> PROFİLLER / PROFILES	
PROFİL FİHRİSTİ / PROFILE INDEX	: 7 ... 16
YALITIMLI PROFİLLER / INSULATED PROFILES	: 17 ... 34
YALITIMSIZ PROFİLLER / UNINSULATED PROFILES	: 35 ... 51
CAM ÇITASI PROFİLLERİ / GLAZING BEAD PROFILES	: 55 , 56
ALÜMİNYUM AKSESUAR PROFİLLERİ / PROFILES OF ALUMINIUM ACCESORIES	: 51 ... 54
> DETAYLAR / DETAILS	
YALITIMLI SİSTEM DETAYLARI / INSULATED SYSTEM DETAILS	: 58 ... 101
YALITIMSIZ SİSTEM DETAYLARI / UNINSULATED SYSTEM DETAILS	: 103 ... 145
İÇE AÇILIR BİNİLİ KAPI / INWARD OPENNING DOOR WITH STEP HINGE	: 74 ... 79
KATLANIR KAPI / FOLDING DOOR	: 80 ... 83
DIŞA AÇILIR BİNİLİ KAPI / OUTWARD OPENNING DOOR WITH STEP HINGE	: 74 ... 79
İÇE AÇILIR HEMYÜZ KAPI / INWARD OPENNING FLUSH DOOR	: 90 ... 95
DIŞA AÇILIR HEMYÜZ KAPI / OUTWARD OPENNING FLUSH DOOR	: 96 ... 101
ÇARPMA KAPI / SWING DOOR	: 126 , 127
> AKSESUARLAR / ACCESSORIES	
AKSESUAR FİHRİSTİ / ACCESSORY INDEX	: 147 ... 152
FİTİLLER / GASKETS	: 153
KÖŞE TAKOZLARI / CORNER CLEATS	: 154 ... 162
U BAĞLANTILAR / U CONNECTIONS	: 163 , 164
KOLLAR / HANDLES	: 179 ... 182
MENTEŞELER / HINGES	: 176 ... 178
ÇİFT AÇILIM SETLERİ / TILT AND TURN KITS	: 165 , 166
KAPI AKSESUARLARI / DOOR ACCESSORIES	: 170 ... 175

TEKNİK ÖZELLİKLER / TECHNICAL PROPERTIES

Alüminyum profil üretim tesisimiz **ISO 9001 , ISO 14001 , ISO 18001** kalite güvence belgelerine sahiptir.

1-Profil Hammaddesi (Raw Material) : AA 6063 (AlMgSi 0.5 F22) , **EN 573-3**

2-Mekanik Özellikler (Mechanical Properties) : **EN 755-2**

Elastisite Modülü (Elasticity Modul) : 7000 kN/cm²

Kopma Mukavemeti (Yield Strenght) : 215 N/mm²

Akma Mukavemeti (Flow Strenght) : 160 N/mm²

Uzama (Elongation) : minimum 6 %

Sertlik (Hardness) : 70 HRB

3-Bariyer Hammaddesi

a-PA 66 GF 25 (25 % cam elyaf takviyeli polyamid) (25 % the manufactured from glass stiffened polyamid) :

Eloksal ve toz boya işleminden **önce** yerleştirilir. (Placed into the aluminium profiles **before** anodic oxidation and powder coating.)

b- PVC :

Eloksal ve toz boya işleminden **sonra** yerleştirilir. (Placed into the aluminium profiles **after** anodic oxidation and powder coating.)

PVC bariyerler, Polyamid bariyerlere göre 10 % daha ağırdır. (PVC insulation bars are 10 % heavier than Polyamid insulation bars .)

4-Eloksal (Anodic Oxidation)

Eloksallı Ürünler İlişkin Teknik Resim Standardı : **DIN 17611 , EN 12371-1 (QUALANOD)**

(The Standarts of Technical Delivery Terms Regarding Eloxal Products)

Eloksal Tabakasının Kalınlığı (Thickness of Eloxal Coating): 10-15 mikron, **EN ISO 2360**

Daldırma ve Renklendirme Standardı (The Standarts of Immersion Coloring) : **DIN 50018**

Tesbit İşlemi Standardı (Sealing Standarts) : **EN 12373-5 , ISO 3210 (TS 2676)**

5-Toz Boya Standartları (The Standarts of Powder Coating)

Kalınlık (Thickness) : min. 60 mikron

Adhezyon (Adhesion) : **EN ISO 2409**

Esneklik (Elasticity) : **EN ISO 1519**

Deformasyon (Deformation) : **EN ISO 6272-1**

Sertlik (Hardness) : **EN ISO 2815**

6-Yüzey Görünümü (Surface Appearance) : Gözle yapılacak kontrolde,yüzey üzerinde kaplanmış alan,çizik,pütürlük,kabarıklık,leke,soyulma vb. hatalar görülmemelidir. (By visual observation,there has been no defects seen on the surface,such as stratches cramped shapes,swellings,stain etc. on the exposed areas.)

7-Tüm Fitiller (All gaskets)

Hammadde (Raw material) : EPDM

Derz fitilleri hammaddesi (Raw material of Gaskets for suture) : Silikon (Silicone)

Ölçü Toleransları Standardı (Measurement Tolerances Standarts) : **DIN ISO 3302-1/E2**

Kalite Kontrol Standardı (Quality Control Standart) : **RAL-GZ 716**

8-Profil Tasarım ve Üretimindeki Ölçü Toleransları Standartları : **EN 12020-2 , EN 755-9**

(Measurement Tolerances Standarts for Profile Design and Manufacturing)

MENTEŞELİ EKONOMİK DOĞRAMA SİSTEMİ

ECONOMICAL HINGED SYSTEM



TEKNİK ÖZELLİKLER

TECHNICAL PROPERTIES

KASA DERİNLİĞİ / FRAME DEPTH :	55 mm
KANAT DERİNLİĞİ / SASH DEPTH :	64,5 mm
PROFİL ET KALINLIĞI / PROFILE WALL THICKNESS :	1,6 mm - 2 mm
MAX. CAM KALINLIĞI / MAX. GLASS THICKNESS :	40 mm
ISI BARIYERLERİ / INSULATION BARS :	15 mm
ISI YALITIM DEĞERİ (Uf) / THERMAL INSULATION VALUE (Uf) :	2,57 W/m ² K -3,45 W/m ² K

KULLANIM SEÇENEKLERİ

APPLICATION ALTERNATIVES

	PENCERE WINDOW	KAPI DOOR
İÇE AÇILIR / INWARD OPENNING :	●	●
DIŞA AÇILIR / OUTSIDE OPENNING :		●
HEMYÜZ KAPI / FLUSH DOOR :		●
ÇİFT EKSEN / TILT&TURN :	●	●
ÇEK-SÜR / TILT&SLIDE :	●	●
KATLANIR / FOLDING :		●
PIVOT / PIVOT :	●	
VASİSTAS / BOTTOM HUNG :	●	

TERMAL PERFORMANS DEĞERLERİ / THERMAL PERFORMANCE VALUES

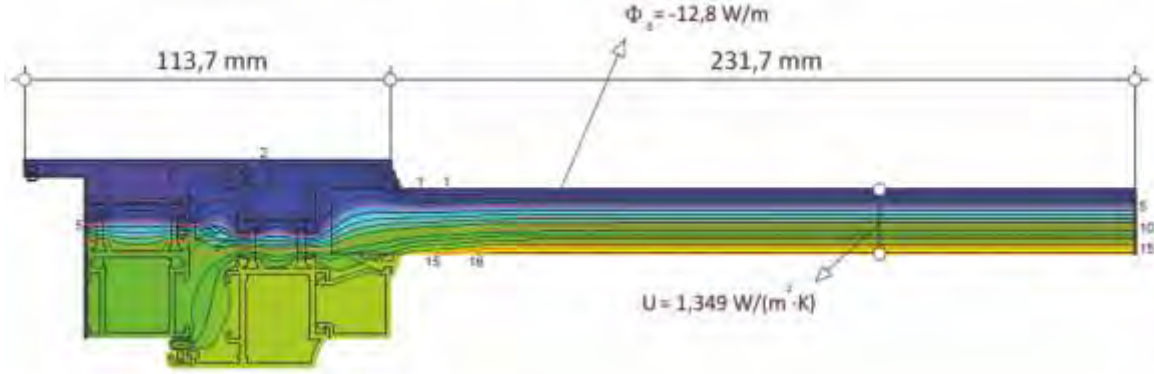

$$U_{TAB} = \frac{\frac{\Phi}{\Delta T} \cdot b_f}{b_f} = \frac{\frac{12,780}{20,000} \cdot 1,349 \cdot 0,232}{0,114} = 2,871 \text{ W/(m}^2 \cdot \text{K)}$$

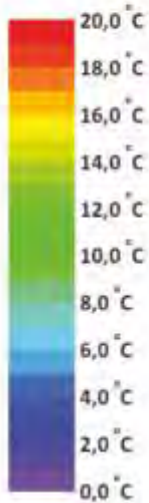

Material

Material	λ [W/(m·K)]	ϵ
Aluminium (Si alloys)	160,000	0,900
EPDM (ethylene propylene diene monomer)	0,250	0,900
PVC, flexible (PVC-P) 40% softener	0,140	0,900
Panel	0,035	0,900
Slightly ventilated air cavity	anisotropic	
Unventilated air cavity	anisotropic	

Boundary Condition

Boundary Condition	q [W/m ²]	θ [°C]	R [(m ² ·K)/W]	ϵ
Epsilon 0.9				0,900
Exterior, frame		0,000	0,040	
Symmetry/Model section	0,000			

** EN 10077-2 standardına göre; iç ortam sıcaklığı 20°C, dış ortam sıcaklığı 0°C ve bağıl nem %50 olarak alınmıştır.
As EN 10077-2 standard; room temperature is 20°C, outer temperature is 0°C and relative humidity is %50.

TERMAL PERFORMANS DEĞERLERİ / THERMAL PERFORMANCE VALUES

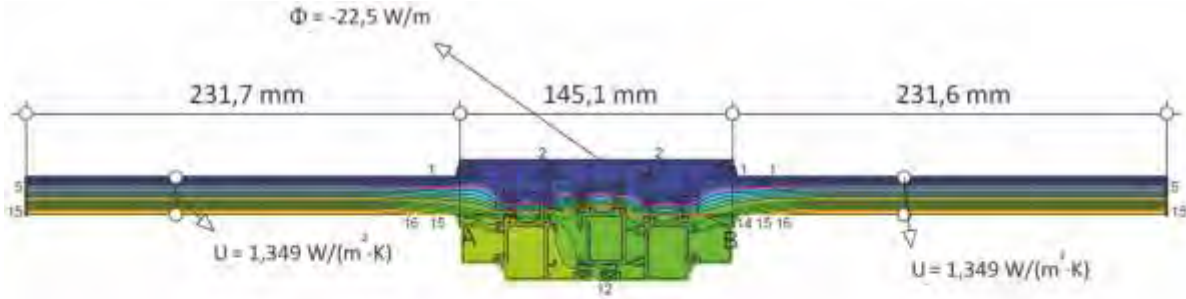

$$U_{\text{FAB}} = \frac{\Phi}{\Delta T} = \frac{U_{p1} \cdot b_{p1} + U_{p2} \cdot b_{p2}}{b_f} = \frac{22,512}{20,000} = \frac{1,349 \cdot 0,232 + 1,349 \cdot 0,232}{0,145} = 3,451 \text{ W}/(\text{m}^2 \cdot \text{K})$$

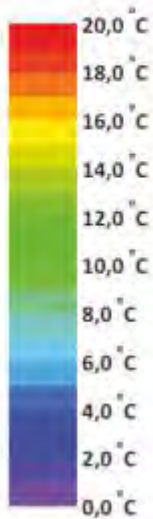
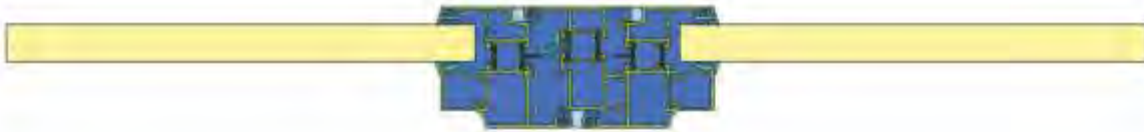

Material

Material	λ [W/(m·K)]	ϵ
Aluminium (Si alloys)	160,000	0,900
EPDM (ethylene propylene diene monomer)	0,250	0,900
PVC, flexible (PVC-P) 40% softener	0,140	0,900
Panel	0,035	0,900
Slightly ventilated air cavity	anisotropic	
Unventilated air cavity	anisotropic	

Boundary Condition

Boundary Condition	q [W/m ²]	θ [°C]	R [(m ² ·K)/W]	ϵ
Epsilon 0.9				0,900
Exterior, frame		0,000	0,040	
Symmetry/Model section	0,000			

** EN 10077-2 standardına göre; iç ortam sıcaklığı 20°C, dış ortam sıcaklığı 0°C ve bağıl nem %50 olarak alınmıştır.
As EN 10077-2 standard; room temperature is 20°C, outer temperature is 0°C and relative humidity is %50.

TERMAL PERFORMANS DEĞERLERİ / THERMAL PERFORMANCE VALUES

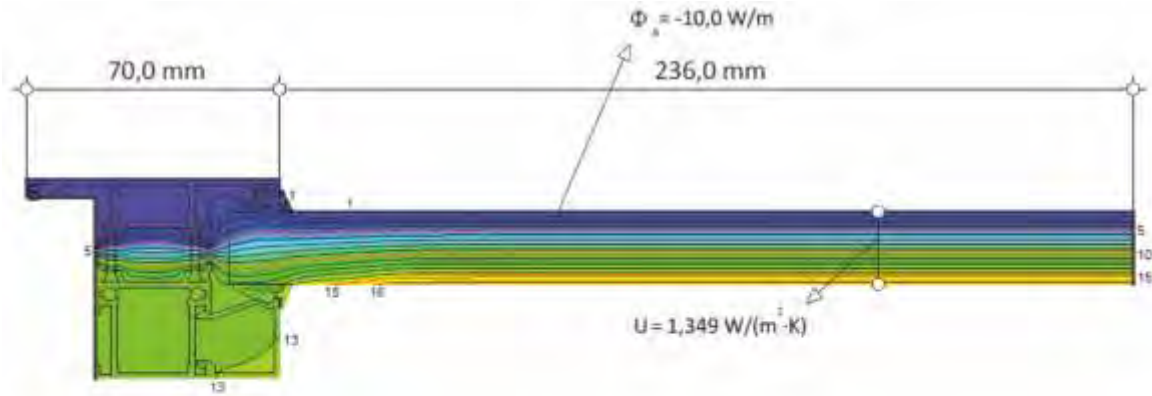

$$U_{TAB} = \frac{\Phi}{\Delta T} = \frac{U \cdot b_f}{b_t} = \frac{9,968}{20,000} = \frac{1,349 \cdot 0,236}{0,070} = 2,573 \text{ W/(m}^2 \cdot \text{K)}$$

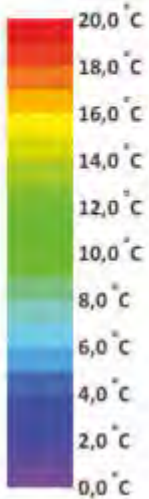

Material	λ [W/(m·K)]	ϵ
Aluminium (Si alloys)	160,000	0,900
EPDM (ethylene propylene diene monomer)	0,250	0,900
PVC, flexible (PVC-P) 40% softener	0,140	0,900
Panel	0,035	0,900
Unventilated air cavity	anisotropic	







Boundary Condition	q [W/m ²]	θ [°C]	R [(m ² ·K)/W]	ϵ
Epsilon 0.9				0,900
Exterior, frame		0,000	0,040	
Symmetry/Model section	0,000			

** EN 10077-2 standardına göre; iç ortam sıcaklığı 20°C, dış ortam sıcaklığı 0°C ve bağıl nem %50 olarak alınmıştır.
As EN 10077-2 standard; room temperature is 20°C, outer temperature is 0°C and relative humidity is %50.

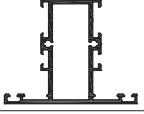
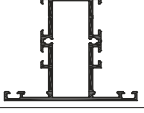
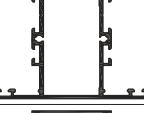
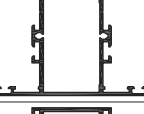
PROFİL NUM. PROFILE NO.	ÇİZİM DRAWING	TANIM DESCRIPTION	STATİK Jx (cm ⁴) Jy (cm ⁴)	AĞIRLIK WEIGHT (kg/m)	SAYFA PAGE
1000-12		LAMBİRİ PROFİLİ PANEL PROFILE	-	0,635	49
1000-20		LAMBİRİ PROFİLİ PANEL PROFILE	-	0,992	49
1841-18		DİKME DESTEK PROFİLİ SUPPORTING PROFILE FOR MULLIONS	-	1,119	
2000-12		LAMBİRİ PROFİLİ PANEL PROFILE	-	0,395	49
2000-20		LAMBİRİ PROFİLİ PANEL PROFILE	-	0,635	49
3061-12		KÖR KASA T PROFİLİ T PROFILE FOR FRAME	-	0,225	47
3062-12		KÖR KASA T PROFİLİ T PROFILE FOR FRAME	-	0,190	47
3080-20		LAMBİRİ PROFİLİ PANEL PROFILE	-	1,482	49
3139-15		KÖR KASA T PROFİLİ T PROFILE FOR FRAME	-	0,290	47
4276-12		KÖR KASA T PROFİLİ T PROFILE FOR FRAME	-	0,249	47
4276-16		KÖR KASA T PROFİLİ T PROFILE FOR FRAME	34,26 8,49	0,331	47
4288-15		KÖR KASA T PROFİLİ T PROFILE FOR FRAME	-	0,435	47
4314-12		LAMBİRİ PROFİLİ PANEL PROFILE	-	0,830	49
4479-13		KÖR KASA T PROFİLİ T PROFILE FOR FRAME	-	0,280	47
4777-15		KÖR KASA T PROFİLİ T PROFILE FOR FRAME	-	0,530	47

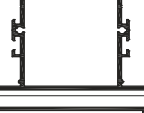
PROFİL NUM. PROFILE NO.	ÇİZİM DRAWING	TANIM DESCRIPTION	STATİK Jx (cm ⁴) Jy (cm ⁴)	AĞIRLIK WEIGHT (kg/m)	SAYFA PAGE
4900-20		KÖR KASA T PROFİLİ T PROFILE FOR FRAME	-	0,365	47
4967-20		KÖR KASA T PROFİLİ T PROFILE FOR FRAME	-	0,425	47
5375-15.3		KÖŞE TAKOZU PROFİLİ CORNER CLEAT PROFILE	-	2,535	52
5580-19		KÖŞE TAKOZU PROFİLİ CORNER CLEAT PROFILE	-	2,700	52
5580-49		KÖŞE TAKOZU PROFİLİ CORNER CLEAT PROFILE	-	5,427	54
5680-14		KÖŞE TAKOZU PROFİLİ CORNER CLEAT PROFILE	-	3,639	52
5680-24		KÖŞE TAKOZU PROFİLİ CORNER CLEAT PROFILE	-	3,091	52
5680-29		KÖŞE TAKOZU PROFİLİ CORNER CLEAT PROFILE	-	3,875	53
5680-44		KÖŞE TAKOZU PROFİLİ CORNER CLEAT PROFILE	-	5,240	53
5680-59		KÖŞE TAKOZU PROFİLİ CORNER CLEAT PROFILE	-	7,826	54
5690-15		KÖR KASA T PROFİLİ T PROFILE FOR FRAME	-	0,310	48
5691-15		KÖR KASA T PROFİLİ T PROFILE FOR FRAME	-	0,335	48
5692-1.1		KÖR KASA T PROFİLİ T PROFILE FOR FRAME	-	0,205	48
5692-15		KÖR KASA T PROFİLİ T PROFILE FOR FRAME	-	0,300	48
5693-15		KÖR KASA T PROFİLİ T PROFILE FOR FRAME	-	0,355	48

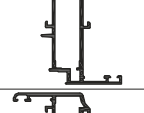
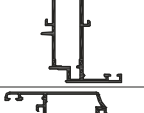
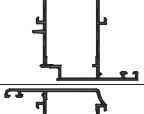
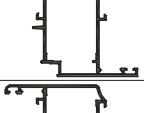
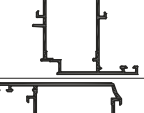
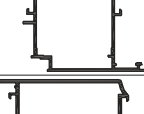
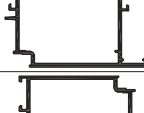

PROFİL NUM. PROFILE NO.	ÇİZİM DRAWING	TANIM DESCRIPTION	STATİK Jx (cm ⁴) Jy (cm ⁴)	AĞIRLIK WEIGHT (kg/m)	SAYFA PAGE
5694-15		KÖR KASA T PROFİLİ T PROFILE FOR FRAME	-	0,280	48
5695-15		KÖR KASA T PROFİLİ T PROFILE FOR FRAME	-	0,255	48
8396-15		KÖR KASA T PROFİLİ T PROFILE FOR FRAME	-	0,317	48
8397-15		KÖR KASA T PROFİLİ T PROFILE FOR FRAME	-	0,385	48
20300		YALITIMLI ORTA KAYIT BAĞLANTI PROFİLİ U CONNECTION FOR INSULATED TRANSOM PROFILE	-	0,264	51
S5614-00		KANAT ADAPTÖR PROFİLİ VENT ADAPTER PROFILE	-	0,403	51
S5671-00		TİJ PROFİLİ ROD PROFILE	-	0,145	51
S54012-18		DAR KASA PROFİLİ NARROW FRAME PROFILE	15,25 7,14	1,084	35
S54020-14		ORTA KASA PROFİLİ CENTER FRAME PROFILE	16,92 10,23	1,014	35
S54020-18		ORTA KASA PROFİLİ CENTER FRAME PROFILE	17,82 12,96	1,181	35
S54020-20		ORTA KASA PROFİLİ CENTER FRAME PROFILE	18,88 13,43	1,265	35
S54030-20		DAR KANAT PROFİLİ NARROW VENT PROFILE	24,68 32,98	1,482	36
S54110-20		ETEK PROFİLİ SILL PROFILE	33,59 64,34	1,808	45
S54112-20		ETEK PROFİLİ SILL PROFILE	40,64 122,46	2,079	45
S54115-20		ETEK PROFİLİ SILL PROFILE	51,91 266,6	2,512	46







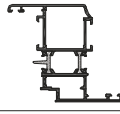
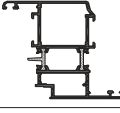
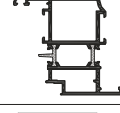
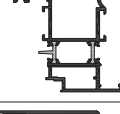
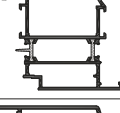
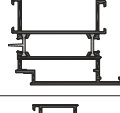
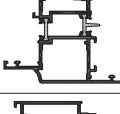
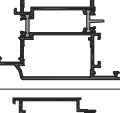
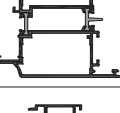
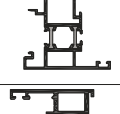
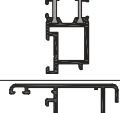
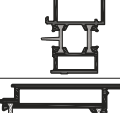
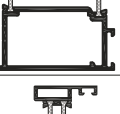
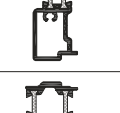



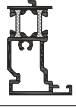

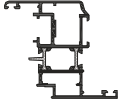
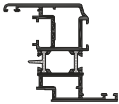
PROFİL NUM. PROFILE NO.	ÇİZİM DRAWING	TANIM DESCRIPTION	STATİK Jx (cm ⁴) Jy (cm ⁴)	AĞIRLIK WEIGHT (kg/m)	SAYFA PAGE
S54202-16		DAR ORTA KAYIT PROFİLİ NARROW TRANSOM PROFILE	16,28 10,22	1,127	36
S54202-20		DAR ORTA KAYIT PROFİLİ NARROW TRANSOM PROFILE	18,41 10,94	1,288	36
S54210-14		ORTA KAYIT PROFİLİ TRANSOM PROFILE	17,27 16,28	1,124	37
S54210-18		ORTA KAYIT PROFİLİ TRANSOM PROFILE	19,98 17,77	1,306	37
S54210-20		ORTA KAYIT PROFİLİ TRANSOM PROFILE	21,30 18,51	1,396	37
S54220-20		ORTA KAYIT PROFİLİ TRANSOM PROFILE	27,07 41,46	1,614	38
S54240-20		ORTA KAYIT PROFİLİ TRANSOM PROFILE	37,08 111,52	1,993	38
S54340-14		DAR KANAT PROFİLİ NARROW VENT PROFILE	20,46 6,96	1,020	39
S54340-18		DAR KANAT PROFİLİ NARROW VENT PROFILE	23,66 7,49	1,198	39
S54350-14		KANAT PROFİLİ VENT PROFILE	24,64 15,57	1,132	39
S54350-16		KANAT PROFİLİ VENT PROFILE	31,88 11,35	1,236	40
S54350-18		KANAT PROFİLİ VENT PROFILE	28,97 17,28	1,344	40
S54360-16		KANAT PROFİLİ VENT PROFILE	32,07 31,30	1,384	41
S54371-20		KANAT PROFİLİ VENT PROFILE	42,59 57,29	1,765	41
S54390-20		DIŞA AÇILIR KANAT PROFİLİ VENT PROFILE FOR OUTWARD OPENING	39,23 57,09	1,759	42











PROFİL NUM. PROFILE NO.	ÇİZİM DRAWING	TANIM DESCRIPTION	STATİK Jx (cm ⁴) Jy (cm ⁴)	AĞIRLIK WEIGHT (kg/m)	SAYFA PAGE
S54500-15		ÇİFT KANAT ADAPTÖR PROFİLİ ADAPTER PROFILE FOR DOUBLE VENT	14,32 6,82	0,978	42
S54510-18		DIŞA AÇILIM ADAPTÖR PROFİLİ ADAPTER PROFILE FOR OUTWARD OPENING	11,55 38,49	0,913	42
S54520-18		PİVOT ADAPTÖR PROFİLİ ADAPTER PROFILE	15,85 7,69	1,056	42
S54560-00		ÇARPMA KAPI ADAPTÖR PROFİLİ ADAPTER PROFILE FOR SWING DOOR HINGE	-	0,492	51
S54580-18		KÖŞE DÖNÜŞ PROFİLİ CORNER PROFILE	-	0,510	50
S54610-18		90° KÖŞE DÖNÜŞ PROFİLİ 90° CORNER PROFILE	-	0,996	50
S54630-18		135° KÖŞE DÖNÜŞ PROFİLİ 135° CORNER PROFILE	-	0,567	50
S54660-18		KÖŞE DÖNÜŞ PROFİLİ CORNER PROFILE	-	0,310	50
S54700-00		ÇARPMA KAPI ADAPTÖR PROFİLİ ADAPTER PROFILE FOR SWING DOOR HINGE	-	1,056	51
S54701-20		İÇE AÇILIR HEMYÜZ KAPI PROFİLİ PROFILE FOR INWARD OPENNING COPLANAR DOOR	32,95 18,31	1,392	43
S54702-16		İÇE AÇILIR HEMYÜZ KAPI ORTA ADAPTÖRÜ MIDDLE ADAPTER FOR INWARD OPENNING COPLANAR DOOR	8,40 2,21	0,820	44
S54703-15		DIŞA AÇILIR HEMYÜZ KAPI ADAPTÖRÜ ADAPTER PROFILE FOR OUTWARD OPENNING COPLANAR DOOR	8,89 3,15	0,719	44
S54704-16		DIŞA AÇILIR HEMYÜZ KAPI ADAPTÖRÜ ADAPTER PROFILE FOR OUTWARD OPENNING COPLANAR DOOR	8,23 2,25	0,835	44
S54705-20		DIŞA AÇILIR HEMYÜZ KAPI PROFİLİ PROFILE FOR OUTWARD OPENNING COPLANAR DOOR	27,23 23,66	1,390	43
SZ54170-00		YALITIMSIZ ORTA KAYIT BAĞLANTI PROFİLİ U CONNECTION FOR UNINSULATED TRANSOM PROFILE	-	0,943	51

PROFİL NUM. PROFILE NO.	ÇİZİM DRAWING	TANIM DESCRIPTION	STATİK Jx (cm ⁴) Jy (cm ⁴)	AĞIRLIK WEIGHT (kg/m)	SAYFA PAGE
Y5860-16		KÖŞE DÖNÜŞ PROFİLİ CORNER PROFILE	14,60 13,27	1,290	34
Y5861-16		KÖŞE DÖNÜŞ PROFİLİ CORNER PROFILE	17,05 15,36	1,390	34
Y55012-16		DAR KASA PROFİLİ NARROW FRAME PROFILE	15,00 7,55	1,322	18
Y55012-20		DAR KASA PROFİLİ NARROW FRAME PROFILE	17,09 7,98	1,453	18
Y55020-16		ORTA KASA PROFİLİ CENTER FRAME PROFILE	17,57 13,82	1,495	18
Y55020-20		ORTA KASA PROFİLİ CENTER FRAME PROFILE	20,28 14,82	1,670	18
Y55030-20		KASA PROFİLİ FRAME PROFILE	26,66 37,61	2,104	19
Y55088-20		KASA PROFİLİ FRAME PROFILE	35,02 11,63	1,697	29
Y55089-16		KASA PROFİLİ FRAME PROFILE	49,87 15,52	1,750	27
Y55090-20		KASA PROFİLİ FRAME PROFILE	20,69 11,37	1,590	17
Y55091-16		KASA PROFİLİ FRAME PROFILE	23,05 17,98	1,555	27
Y55091-20		KASA PROFİLİ FRAME PROFILE	29,63 15,67	1,772	27
Y55092-16		KASA PROFİLİ FRAME PROFILE	23,05 17,98	1,555	17
Y55110-20		ETEK PROFİLİ SILL PROFILE	35,53 73,14	2,443	32
Y55112-20		ETEK PROFİLİ SILL PROFILE	43,51 144,9	3,095	32

PROFİL NUM. PROFILE NO.	ÇİZİM DRAWING	TANIM DESCRIPTION	STATİK Jx (cm ⁴) Jy (cm ⁴)	AĞIRLIK WEIGHT (kg/m)	SAYFA PAGE
Y55115-20		ETEK PROFİLİ SILL PROFILE	56,27 333,9	3,962	33
Y55201-16		ORTA KAYIT PROFİLİ TRANSOM PROFILE	15,53 7,93	1,345	19
Y55201-20		ORTA KAYIT PROFİLİ TRANSOM PROFILE	17,56 8,33	1,483	19
Y55202-16		ORTA KAYIT PROFİLİ TRANSOM PROFILE	16,83 10,74	1,432	20
Y55202-20		ORTA KAYIT PROFİLİ TRANSOM PROFILE	19,18 11,37	1,591	20
Y55205-20		ORTA KAYIT PROFİLİ TRANSOM PROFILE	20,79 15,09	1,699	20
Y55210-16		ORTA KAYIT PROFİLİ TRANSOM PROFILE	19,43 18,25	1,605	21
Y55210-18		ORTA KAYIT PROFİLİ TRANSOM PROFILE	22,40 19,55	1,707	21
Y55210-20		ORTA KAYIT PROFİLİ TRANSOM PROFILE	20,92 18,90	1,808	21
Y55212-20		TAKVİYELİ ORTA KAYIT PROFİLİ FORCED TRANSOM PROFILE	71,41 25,92	2,305	21
Y55220-20		ORTA KAYIT PROFİLİ TRANSOM PROFILE	28,82 45,70	2,241	22
Y55240-20		ORTA KAYIT PROFİLİ TRANSOM PROFILE	40,02 131,30	3,000	22
Y55340-18		DAR KANAT PROFİLİ NARROW VENT PROFILE	24,28 7,31	1,448	23
Y55342-16		DAR KANAT PROFİLİ NARROW VENT PROFILE	24,34 9,64	1,447	23
Y55342-20		DAR KANAT PROFİLİ NARROW VENT PROFILE	28,10 10,37	1,642	23

PROFİL NUM. PROFILE NO.	ÇİZİM DRAWING	TANIM DESCRIPTION	STATİK Jx (cm ⁴) Jy (cm ⁴)	AĞIRLIK WEIGHT (kg/m)	SAYFA PAGE
Y55345-16		DAR KANAT PROFİLİ NARROW VENT PROFILE	26,11 12,81	1,556	24
Y55350-16		KANAT PROFİLİ VENT PROFILE	27,85 16,63	1,647	24
Y55350-18		KANAT PROFİLİ VENT PROFILE	30,17 17,41	1,740	24
Y55350-20		KANAT PROFİLİ VENT PROFILE	32,44 18,17	1,859	24
Y55360-16		KANAT PROFİLİ VENT PROFILE	33,95 32,52	1,905	25
Y55370-20		KANAT PROFİLİ VENT PROFILE	41,08 43,73	2,292	25
Y55380-18		DIŞA AÇILIR KANAT PROFİLİ VENT PROFILE FOR OUTWARD OPENING	27,82 17,62	1,786	26
Y55385-16		DIŞA AÇILIR KANAT PROFİLİ VENT PROFILE FOR OUTWARD OPENING	31,58 33,63	1,949	28
Y55390-20		DIŞA AÇILIR KANAT PROFİLİ VENT PROFILE FOR OUTWARD OPENING	38,87 44,30	2,331	28
Y55500-15		ÇİFT KANAT ADAPTÖR PROFİLİ ADAPTER PROFILE FOR DOUBLE VENT	38,87 44,30	1,249	29
Y55510-18		DIŞA AÇILIM ADAPTÖR PROFİLİ ADAPTER PROFILE FOR OUTWARD OPENING	12,06 3,94	1,154	29
Y55520-16		PİVOT ADAPTÖR PROFİLİ ADAPTER PROFILE FOR PIVOTING	16,30 7,02	1,236	29
Y55521-20		İÇE AÇILIR HEMYÜZ KAPI PROFİLİ PROFILE FOR INWARD OPENING COPLANAR DOOR	25,40 43,83	2,058	30
Y55522-16		İÇE AÇILIR HEMYÜZ KAPI ORTA ADAPTÖRÜ MIDDLE ADAPTER FOR INWARD OPENING COPLANAR DOOR	9,31 2,03	0,958	31
Y55523-16		DIŞA AÇILIR HEMYÜZ KAPI ADAPTÖRÜ ADAPTER PROFILE FOR OUTWARD OPENING COPLANAR DOOR	11,28 3,60	0,960	31

PROFİL NUM. PROFILE NO.	ÇİZİM DRAWING	TANIM DESCRIPTION	STATİK J _x (cm ⁴) J _y (cm ⁴)	AĞIRLIK WEIGHT (kg/m)	SAYFA PAGE
Y55524-16		DIŞA AÇILIR HEMYÜZ KAPI ADAPTÖRÜ ADAPTER PROFILE FOR OUTWARD OPENNING COPLANAR DOOR	9,89 2,38	0,932	31
Y55525-20		DIŞA AÇILIR HEMYÜZ KAPI PROFİLİ PROFILE FOR OUTWARD OPENNING COPLANAR DOOR	26,23 32,01	1,943	32
Y55526		İÇE AÇILIR HEMYÜZ KAPI ADAPTÖRÜ ADAPTER FOR INWARD OPENNING COPLANAR DOOR	-	0,299	31
Y55527-16		PVC KANAT PROFİLİ PVC VENT PROFILE	31,27 10,06	1,601	26
Y55528-20		PVC KANAT PROFİLİ PVC VENT PROFILE	35,27 11,07	1,806	26
5640-15		CAM ÇITASI PROFİLİ 10mm GLAZING BEAD PROFILE	-	0,227	55
5641-15		CAM ÇITASI PROFİLİ 16,6mm GLAZING BEAD PROFILE	-	0,245	55
5641-18		CAM ÇITASI PROFİLİ 16,6mm GLAZING BEAD PROFILE	-	0,300	55
5642-15		CAM ÇITASI PROFİLİ 22mm GLAZING BEAD PROFILE	-	0,260	55
5642-18		CAM ÇITASI PROFİLİ 22mm GLAZING BEAD PROFILE	-	0,325	55
5643-12		CAM ÇITASI PROFİLİ 25,8mm GLAZING BEAD PROFILE	-	0,275	55
5643-15		CAM ÇITASI PROFİLİ 25,8mm GLAZING BEAD PROFILE	-	0,315	55
5643-18		CAM ÇITASI PROFİLİ 25,8mm GLAZING BEAD PROFILE	-	0,395	55
5644-15		CAM ÇITASI PROFİLİ 27,7mm GLAZING BEAD PROFILE	-	0,315	55
5645-18		CAM ÇITASI PROFİLİ 29mm GLAZING BEAD PROFILE	-	0,395	55

PROFİL NUM. PROFILE NO.	ÇİZİM DRAWING	TANIM DESCRIPTION	STATİK Jx (cm ⁴) Jy (cm ⁴)	AĞIRLIK WEIGHT (kg/m)	SAYFA PAGE
5646-15		CAM ÇİTASI PROFİLİ 37,7mm GLAZING BEAD PROFILE	-	0,355	55
5647-15		CAM ÇİTASI PROFİLİ 42,9mm GLAZING BEAD PROFILE	-	0,375	55
6500-14		CAM ÇİTASI PROFİLİ 32,7mm GLAZING BEAD PROFILE	-	0,335	55
7046-14		CAM ÇİTASI PROFİLİ 35,5mm GLAZING BEAD PROFILE	-	0,346	55
5649-12		CAM ÇİTASI PROFİLİ 40mm GLAZING BEAD PROFILE	-	0,320	55
5649-15		CAM ÇİTASI PROFİLİ 40mm GLAZING BEAD PROFILE	-	0,365	55
5649-18		CAM ÇİTASI PROFİLİ 40mm GLAZING BEAD PROFILE	-	0,460	55
ES4540-13		CAM ÇİTASI PROFİLİ 14mm GLAZING BEAD PROFILE	-	0,224	55
ES4545-13		CAM ÇİTASI PROFİLİ 30,5mm GLAZING BEAD PROFILE	-	0,306	55
Y55410-15		CAM ÇİTASI PROFİLİ 19mm GLAZING BEAD PROFILE	-	0,247	55

YALITIMLI SİSTEM PROFİLLERİ INSULATED SYSTEM PROFILES

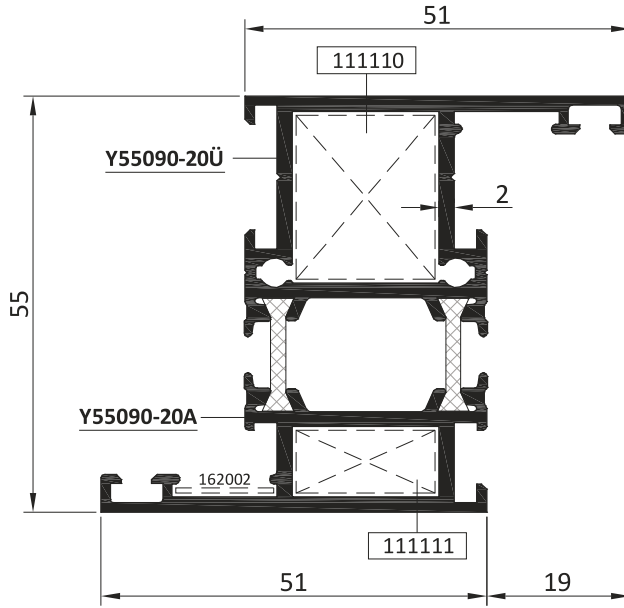

Y55090-20

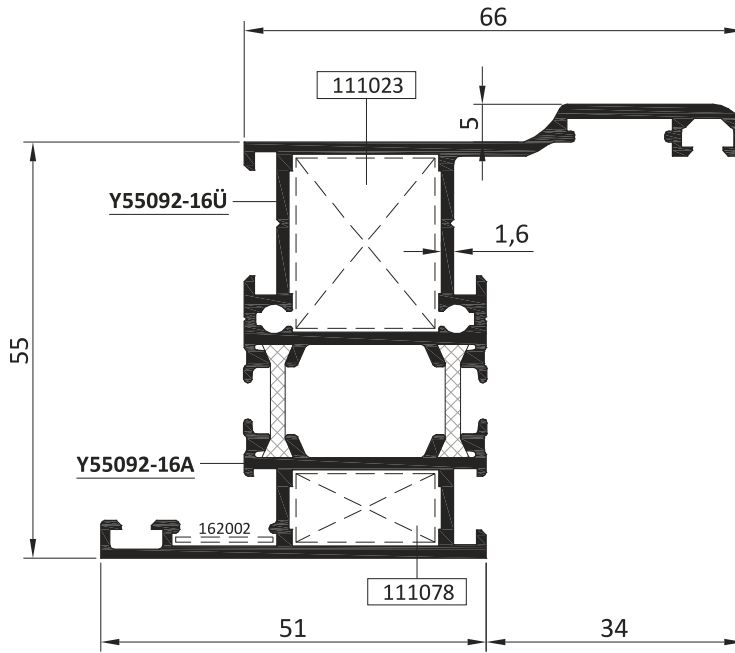

Y55092-16

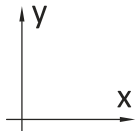

PROFİL NUMARASI PROFILE NO.	Jx (cm ⁴)	Jy (cm ⁴)	AĞIRLIK WEIGHT (kg/m)
Y55090-20	20,69	11,37	1,590
Y55092-12	17,09	7,98	1,555

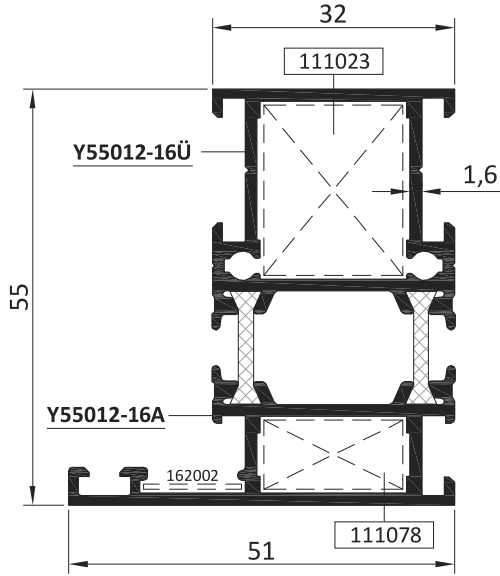
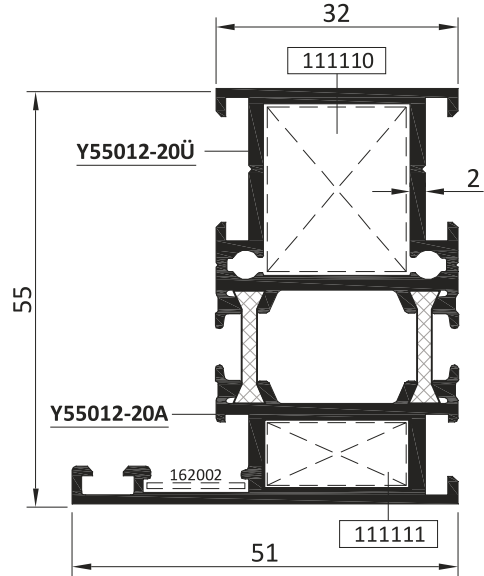
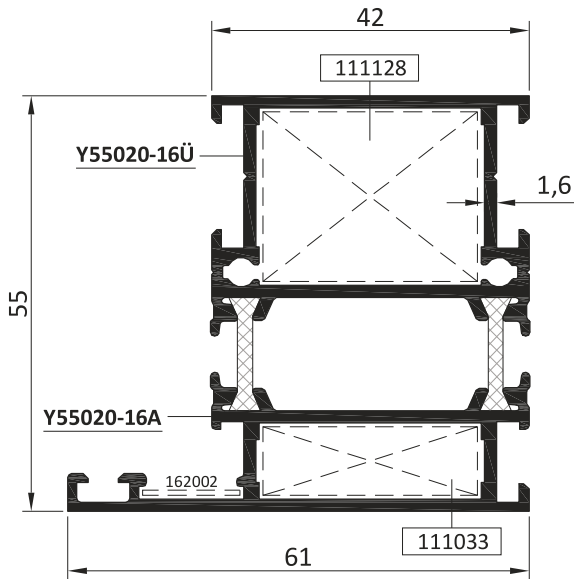
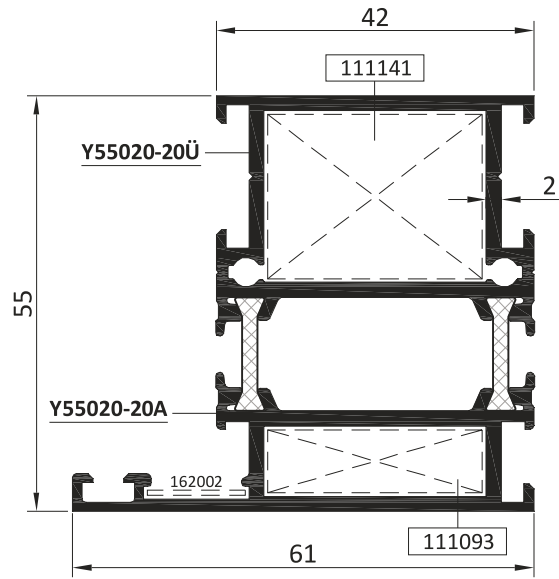
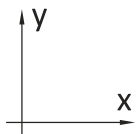
YALITIMLI SİSTEM PROFİLLERİ
 INSULATED SYSTEM PROFILES
**Y55012-16****Y55012-20****Y55020-16****Y55020-20**

PROFİL NUMARASI PROFILE NO.	Jx (cm ⁴)	Jy (cm ⁴)	AĞIRLIK WEIGHT (kg/m)
Y55012-16	15,00	7,55	1,322
Y55012-20	17,09	7,98	1,453
Y55020-16	17,57	13,82	1,495
Y55020-20	20,28	14,82	1,670

YALITIMLI SİSTEM PROFİLLERİ INSULATED SYSTEM PROFILES

Y55030-20

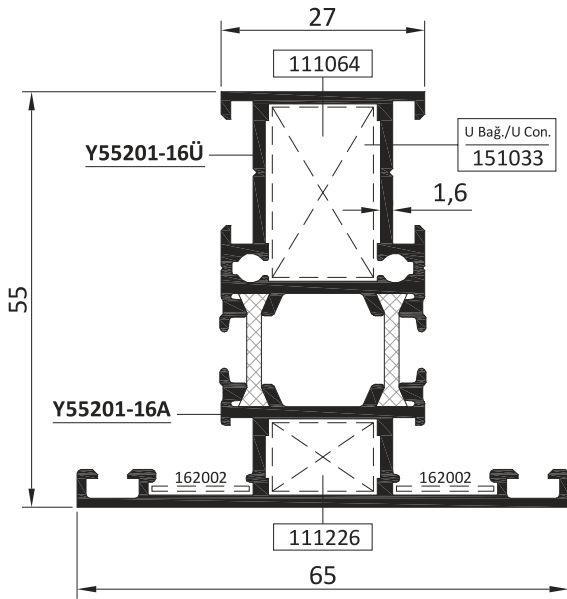
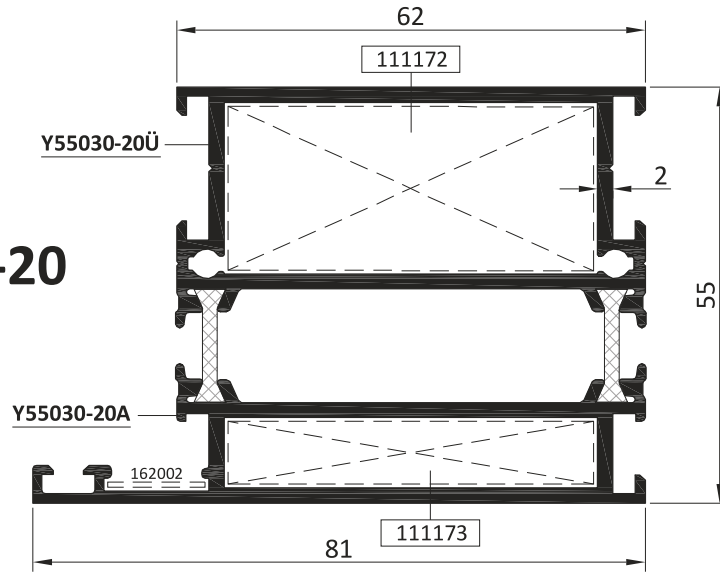

Y55201-16

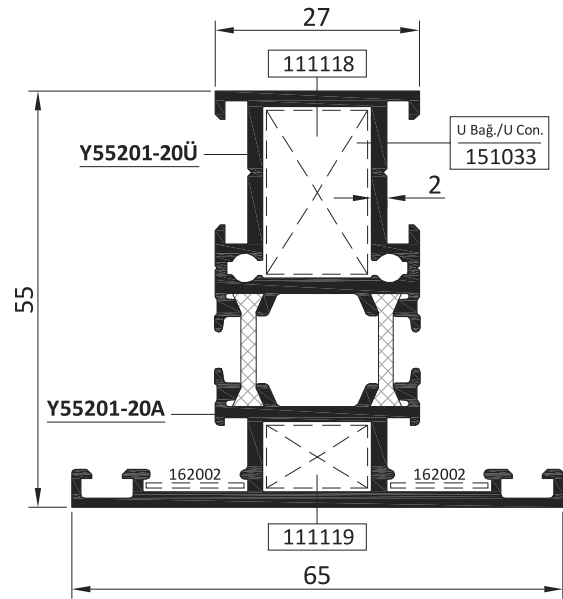

Y55201-20

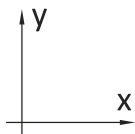

PROFİL NUMARASI PROFILE NO.	Jx (cm ⁴)	Jy (cm ⁴)	AĞIRLIK WEIGHT (kg/m)
Y55030-16	26,66	37,61	2,104
Y55201-16	15,53	7,93	1,345
Y55201-20	17,56	8,33	1,483

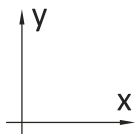
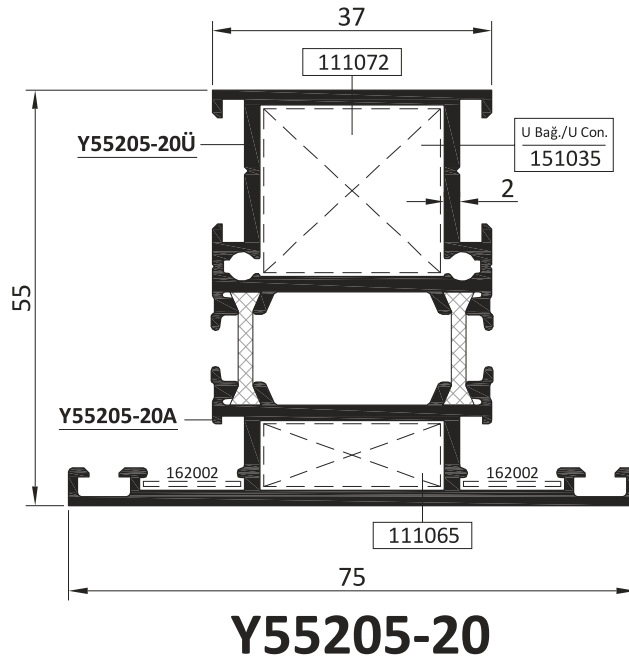
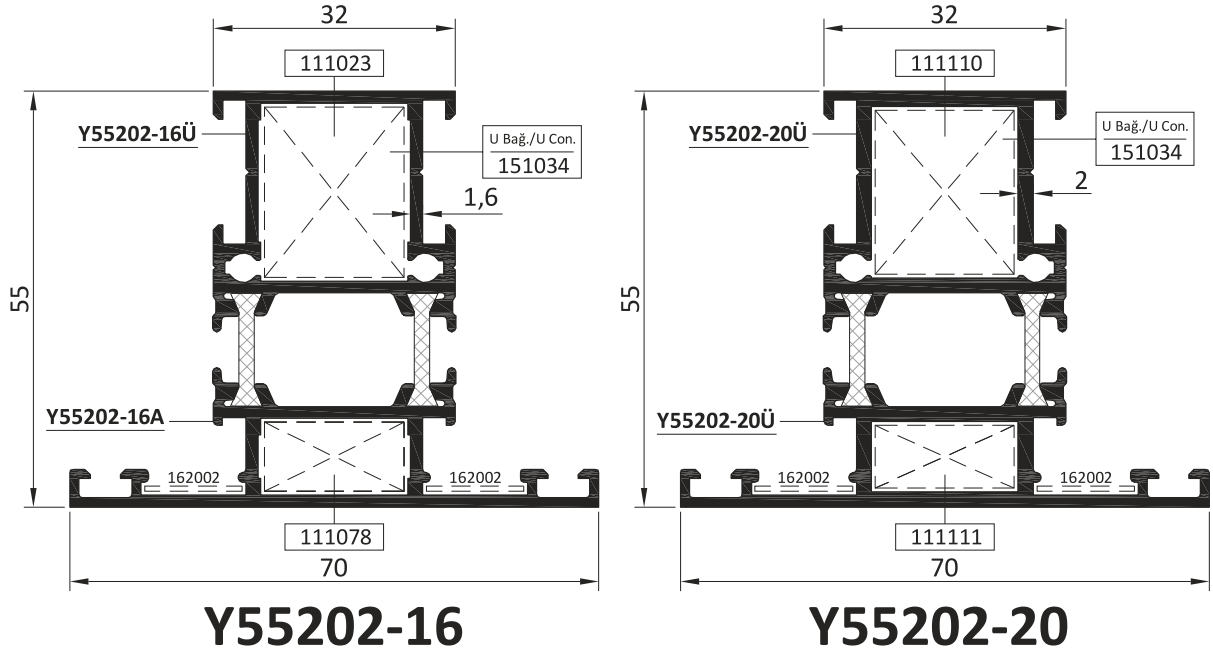
YALITIMLI SİSTEM PROFİLLERİ
 INSULATED SYSTEM PROFILES

PROFİL NUMARASI PROFILE NO.	Jx (cm ⁴)	Jy (cm ⁴)	AĞIRLIK WEIGHT (kg/m)
Y55202-16	16,83	10,74	1,432
Y55202-20	19,18	11,37	1,591
Y55205-20	20,79	15,09	1,699

YALITIMLI SİSTEM PROFİLLERİ INSULATED SYSTEM PROFILES

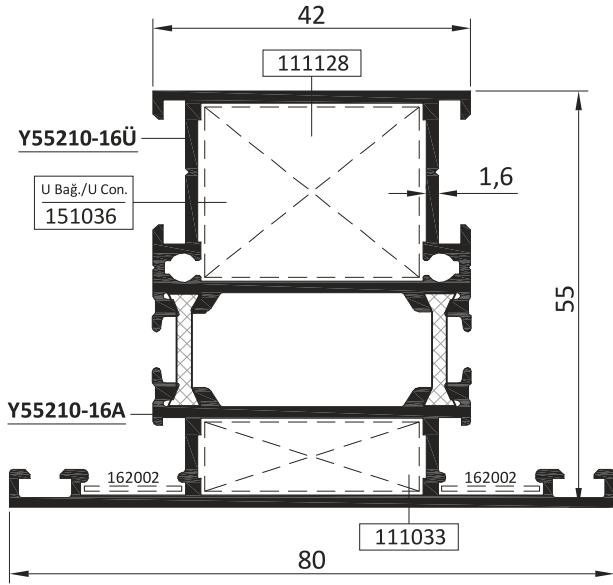

Y55210-16

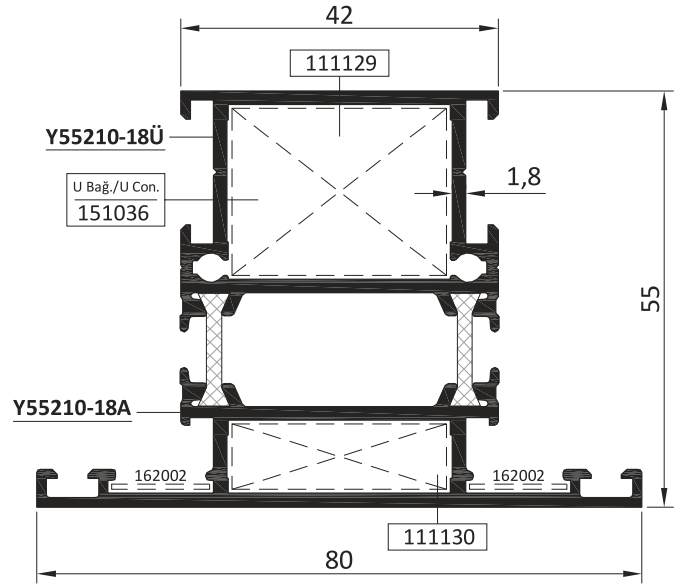

Y55210-18

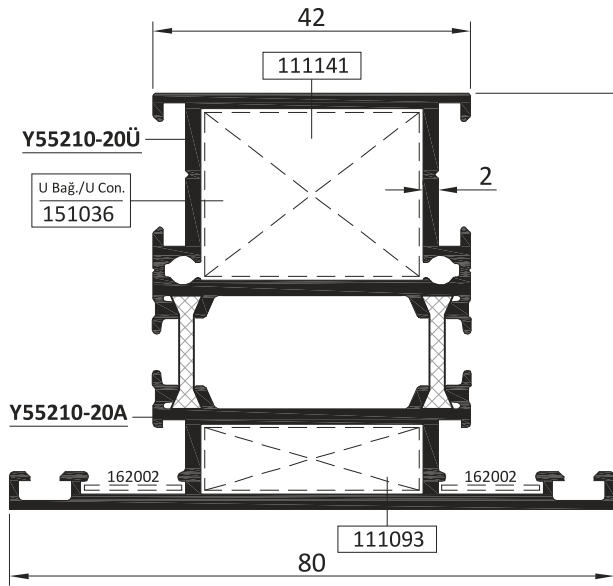

Y55210-20

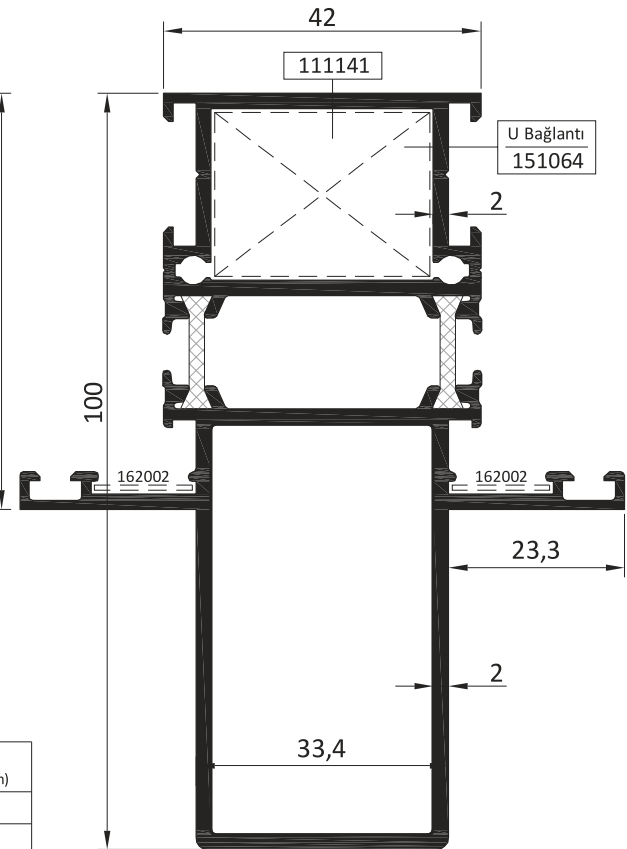

Y55212-20

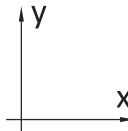

PROFİL NUMARASI PROFILE NO.	Jx (cm ⁴)	Jy (cm ⁴)	AĞIRLIK WEIGHT (kg/m)
Y55210-16	19,62	20,32	1,605
Y55210-18	21,09	20,85	1,707
Y55210-20	21,49	22,56	1,808
Y55212-20	71,41	25,92	2,305

YALITIMLI SİSTEM PROFİLLERİ
INSULATED SYSTEM PROFILES

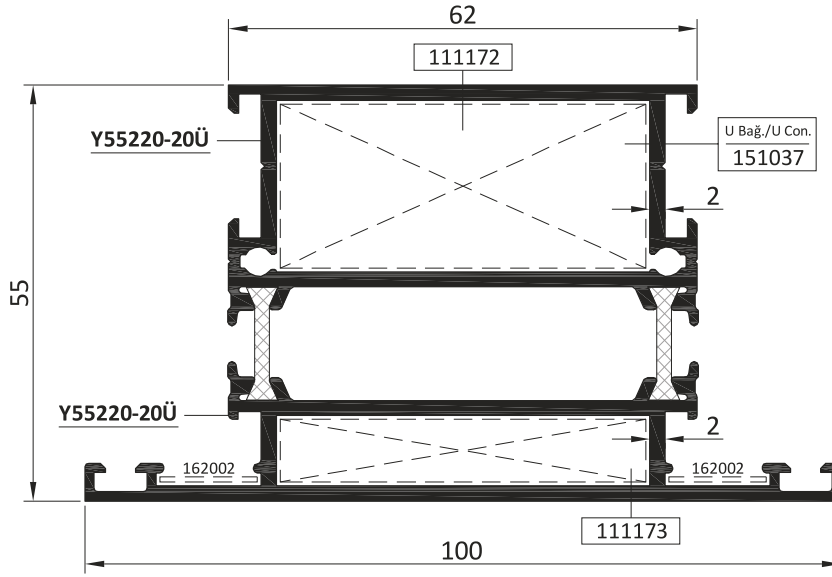

Y55220-20

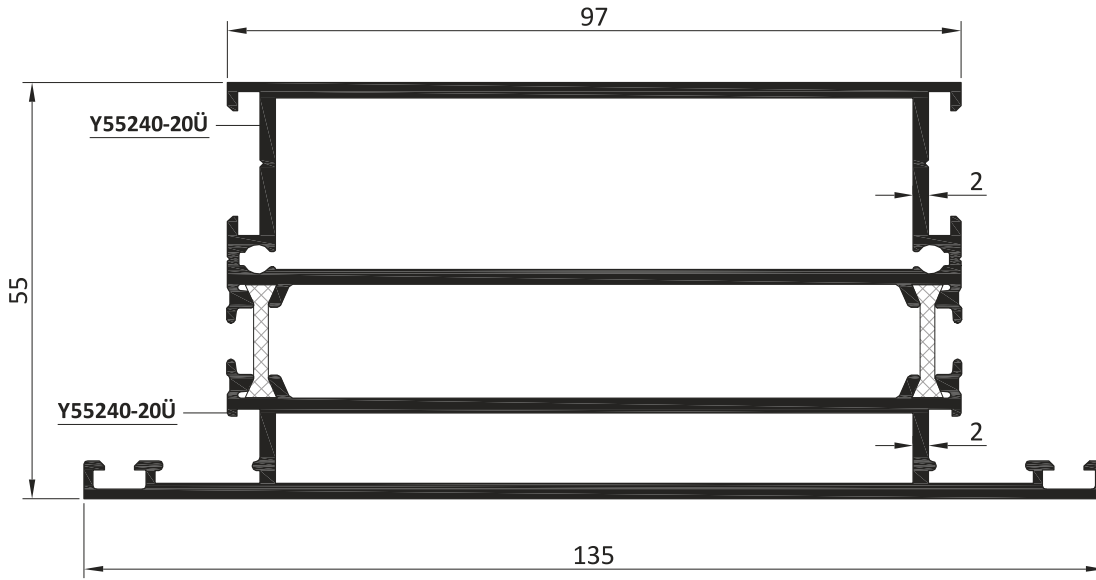

Y55240-20

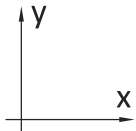

PROFİL NUMARASI PROFILE NO.	Jx (cm ⁴)	Jy (cm ⁴)	AĞIRLIK WEIGHT (kg/m)
Y55220-20	28,82	45,70	2,241
Y55240-20	40,02	131,24	3,000

YALITIMLI SİSTEM PROFİLLERİ INSULATED SYSTEM PROFILES

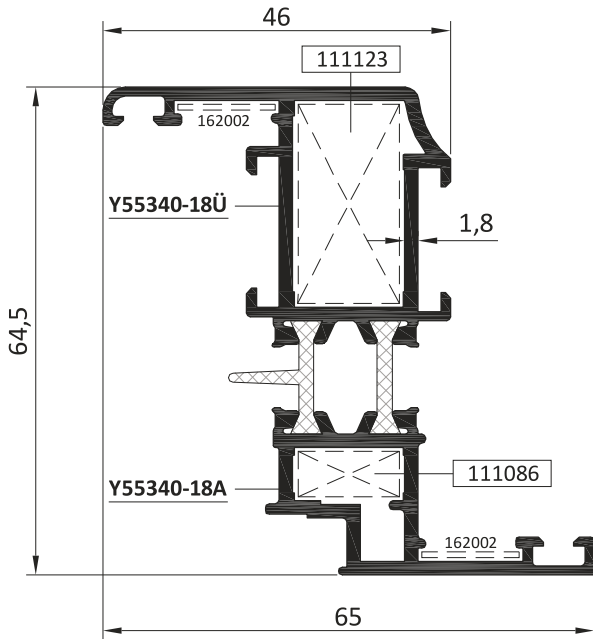

Y55340-18

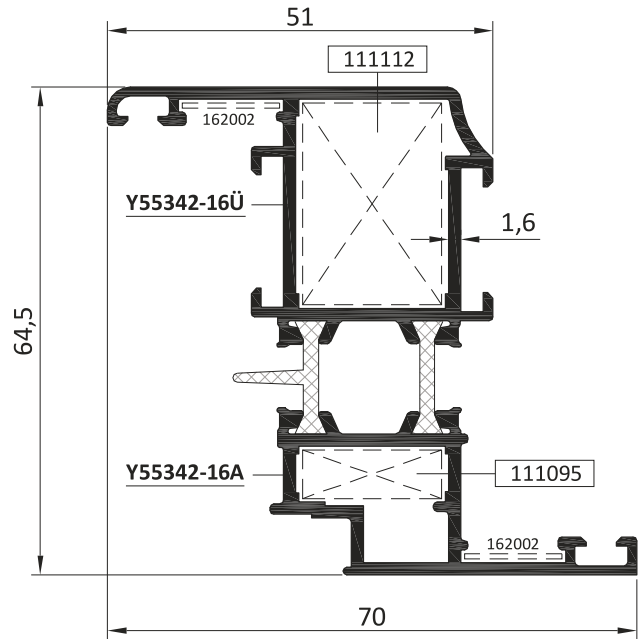

Y55342-16

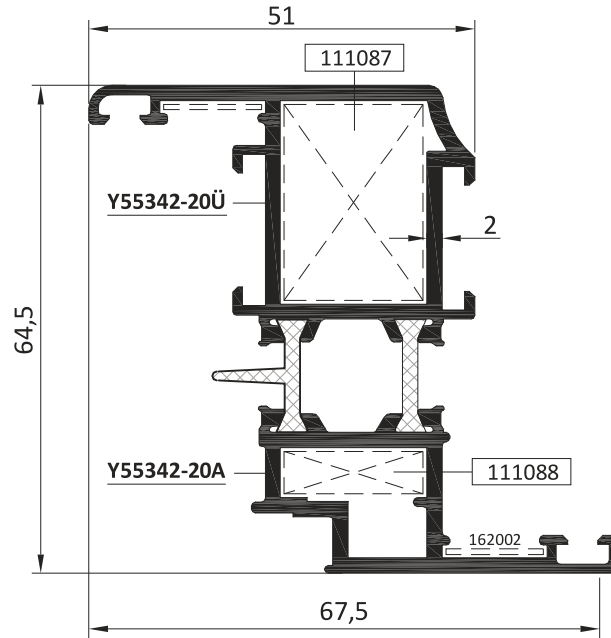

Y55342-20

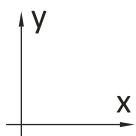

PROFİL NUMARASI PROFILE NO.	Jx (cm ⁴)	Jy (cm ⁴)	AĞIRLIK WEIGHT (kg/m)
Y55340-18	24,28	7,31	1,448
Y55342-16	24,34	9,64	1,447
Y55342-20	28,10	10,37	1,642

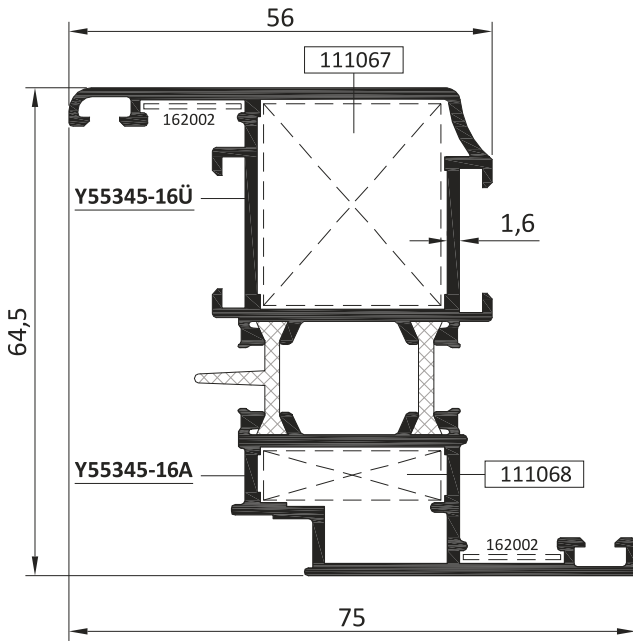
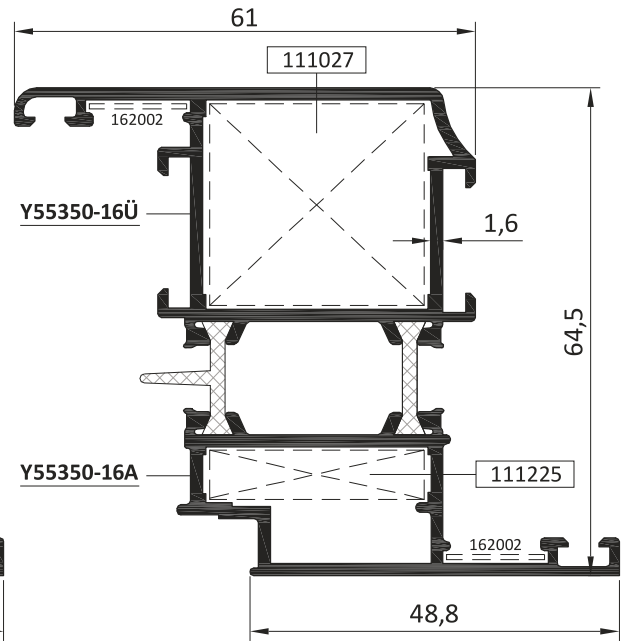
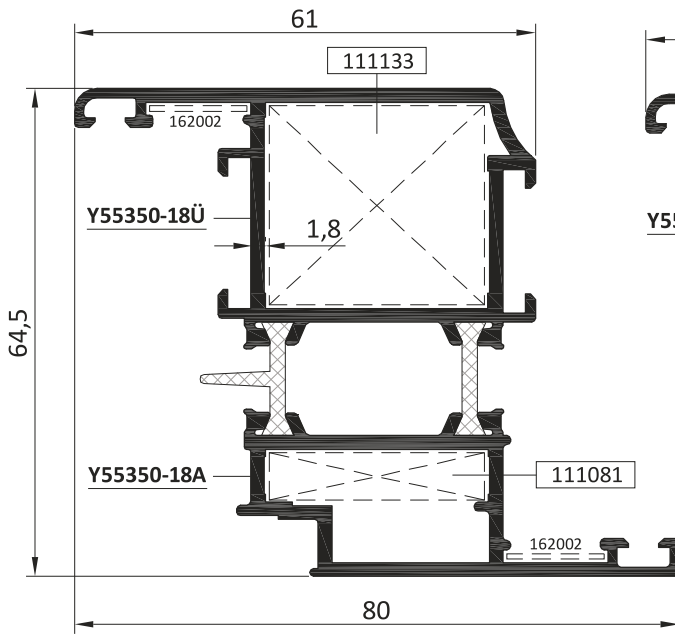
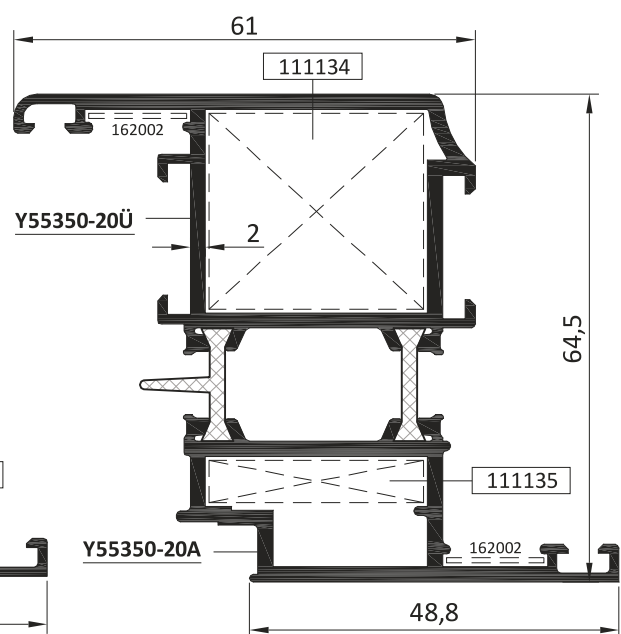
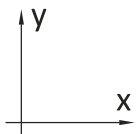
YALITIMLI SİSTEM PROFİLLERİ
INSULATED SYSTEM PROFILES
**Y55345-16****Y55350-16****Y55350-18****Y55350-20**

PROFİL NUMARASI PROFILE NO.	Jx (cm ⁴)	Jy (cm ⁴)	AĞIRLIK WEIGHT (kg/m)
Y55345-16	26,11	12,81	1,556
Y55350-16	27,85	16,63	1,647
Y55350-18	30,17	17,41	1,740
Y55350-20	32,44	18,17	1,859

YALITIMLI SİSTEM PROFİLLERİ INSULATED SYSTEM PROFILES

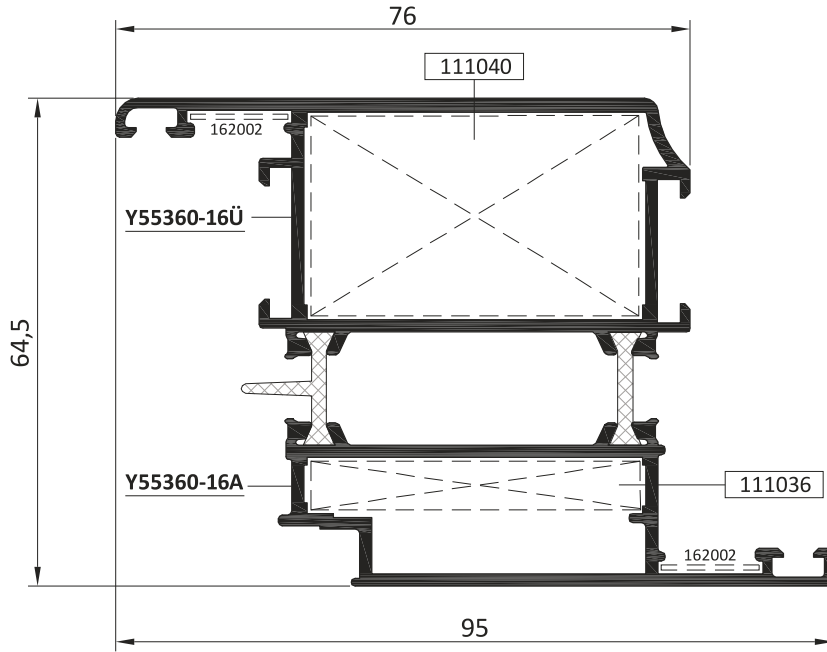

Y55360-16

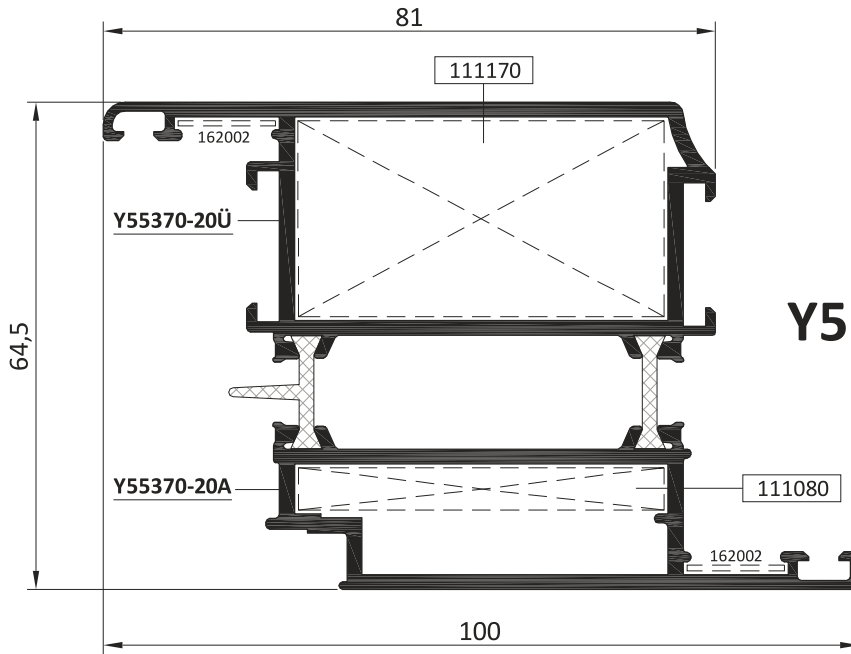

Y55370-20

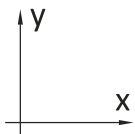

PROFİL NUMARASI PROFILE NO.	Jx (cm ⁴)	Jy (cm ⁴)	AĞIRLIK WEIGHT (kg/m)
Y55360-16	33,95	32,52	1,905
Y55370-20	41,08	43,73	2,292

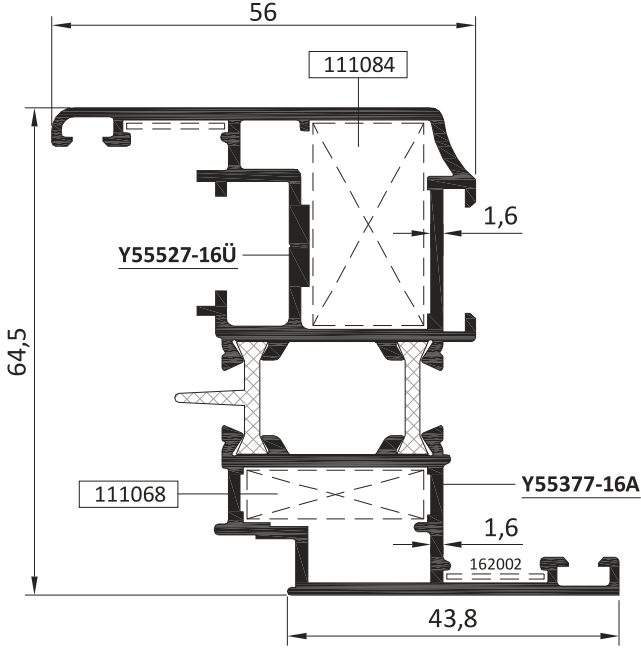
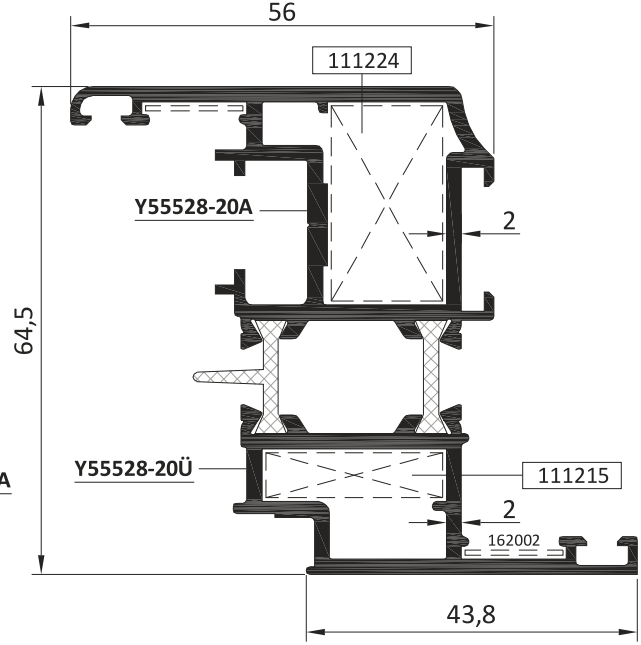
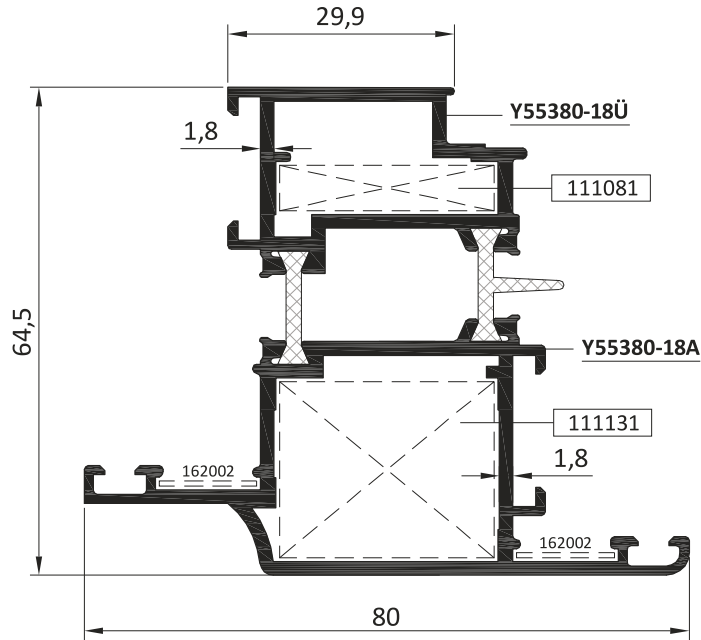
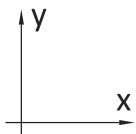
YALITIMLI SİSTEM PROFİLLERİ
 INSULATED SYSTEM PROFILES
**Y55527-16****Y55528-20****Y55380-18**

PROFİL NUMARASI PROFILE NO.	Jx (cm ⁴)	Jy (cm ⁴)	AĞIRLIK WEIGHT (kg/m)
Y55527-16	31,27	10,06	1,601
Y55528-20	35,51	11,07	1,806
Y55380-18	27,82	17,62	1,786

YALITIMLI SİSTEM PROFİLLERİ INSULATED SYSTEM PROFILES

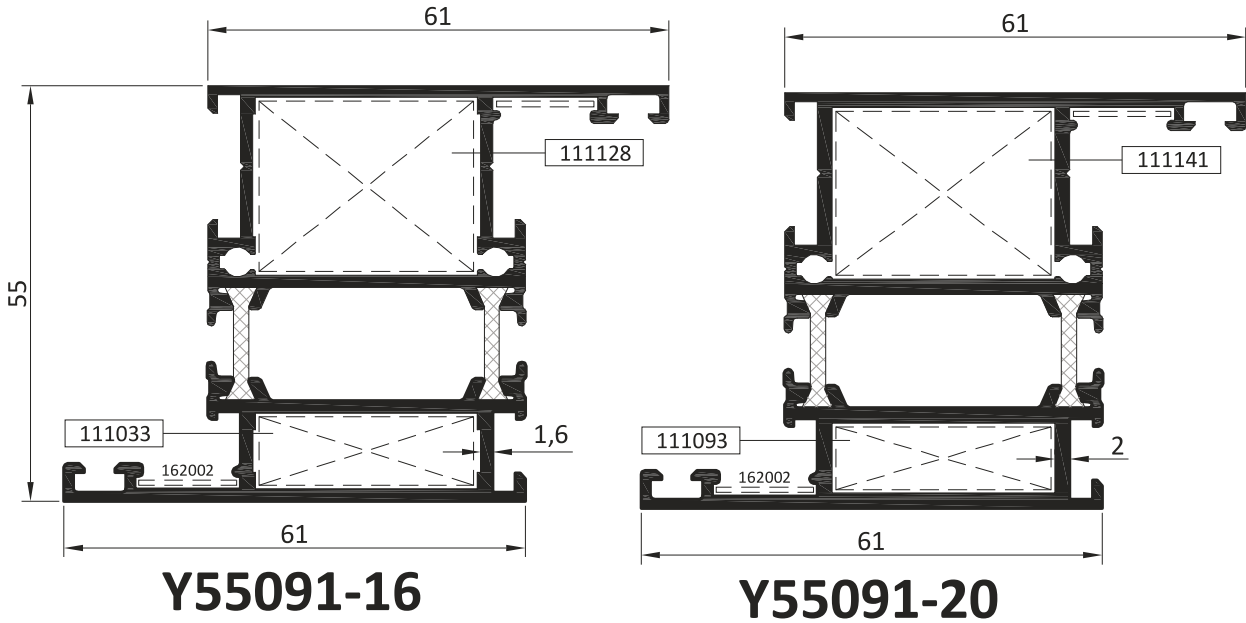

Y55091-16

Y55091-20

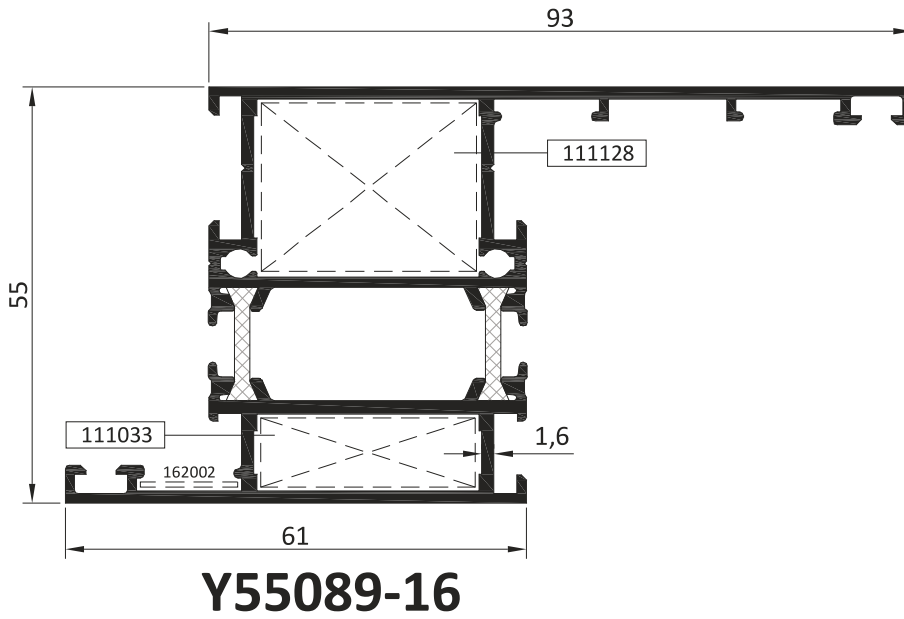

Y55089-16

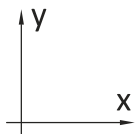

PROFİL NUMARASI PROFILE NO.	Jx (cm ⁴)	Jy (cm ⁴)	AĞIRLIK WEIGHT (kg/m)
Y55089-16	49,87	15,52	1,750
Y55091-16	27,30	14,22	1,582
Y55091-20	29,63	15,67	1,772

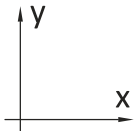
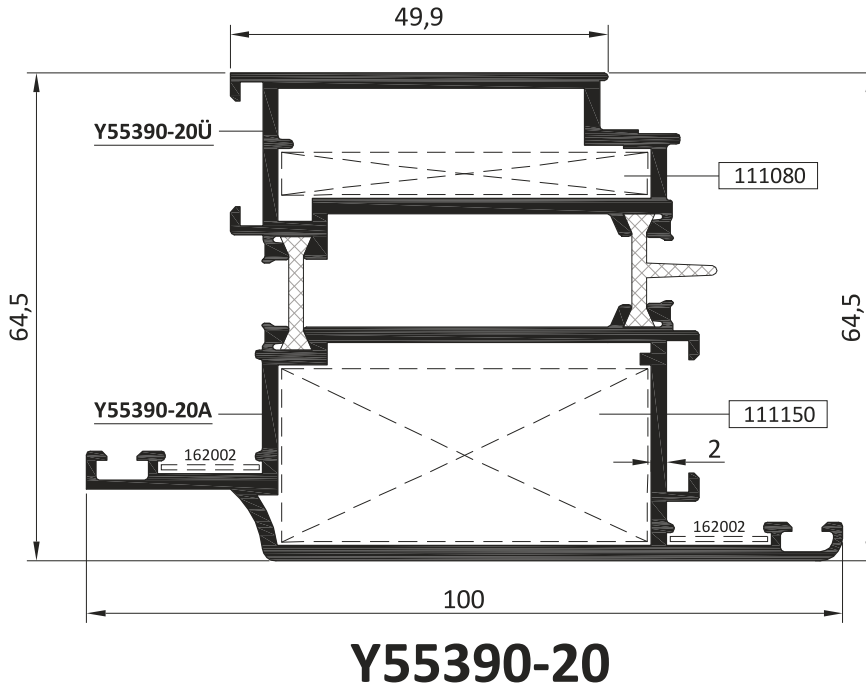
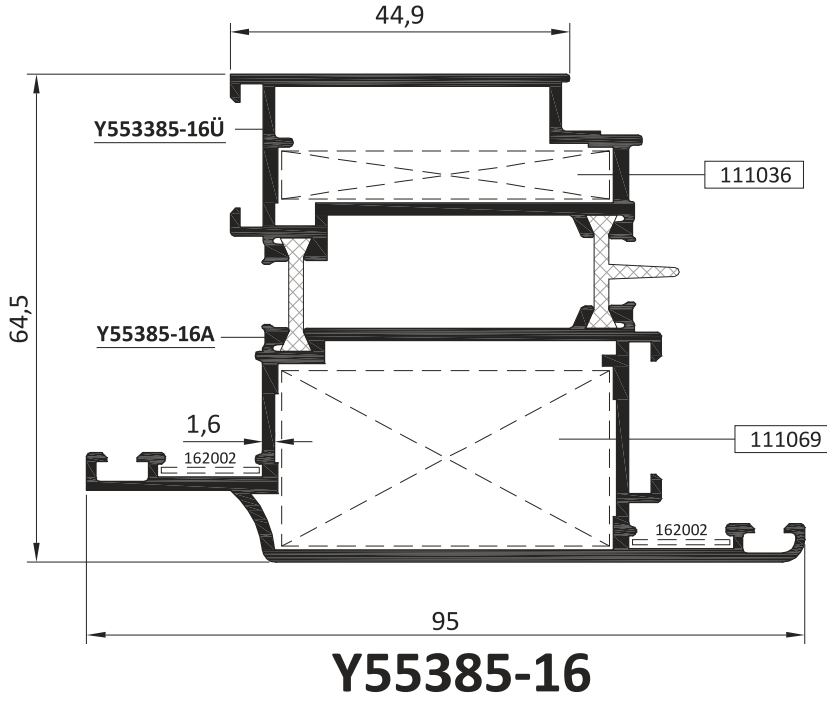
YALITIMLI SİSTEM PROFİLLERİ
INSULATED SYSTEM PROFILES

PROFİL NUMARASI PROFILE NO.	Jx (cm ⁴)	Jy (cm ⁴)	AĞIRLIK WEIGHT (kg/m)
Y55385-16	31,58	33,63	1,949
Y55390-20	38,87	44,30	2,331

YALITIMLI SİSTEM PROFİLLERİ INSULATED SYSTEM PROFILES

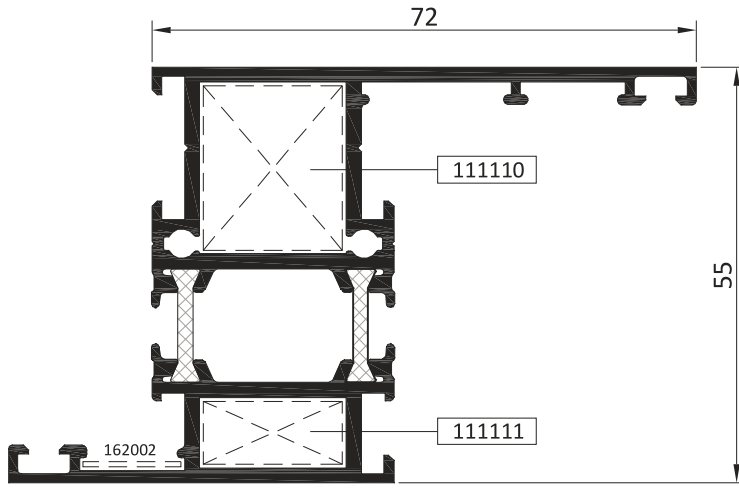

Y55088-20

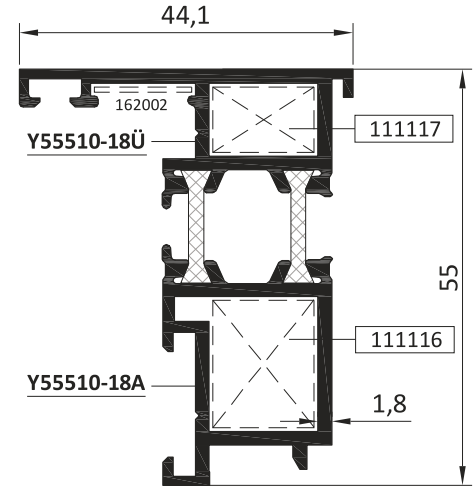

Y55510-18

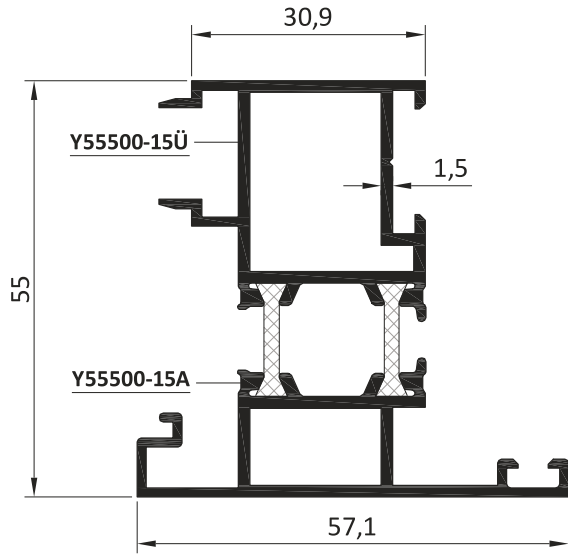

Y55500-15

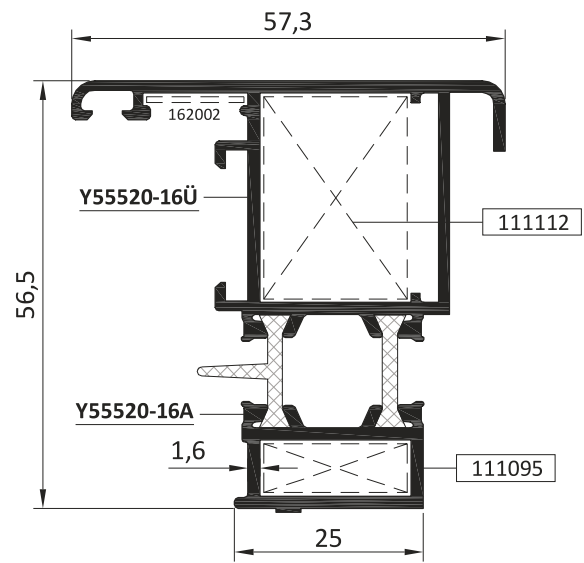

Y55520-16

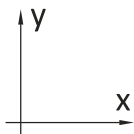

PROFİL NUMARASI PROFILE NO.	Jx (cm ⁴)	Jy (cm ⁴)	AĞIRLIK WEIGHT (kg/m)
Y55088-20	35,02	11,63	1,697
Y55510-15	14,88	12,95	1,249
Y55510-18	12,06	3,94	1,154
Y55520-16	16,30	7,02	1,236

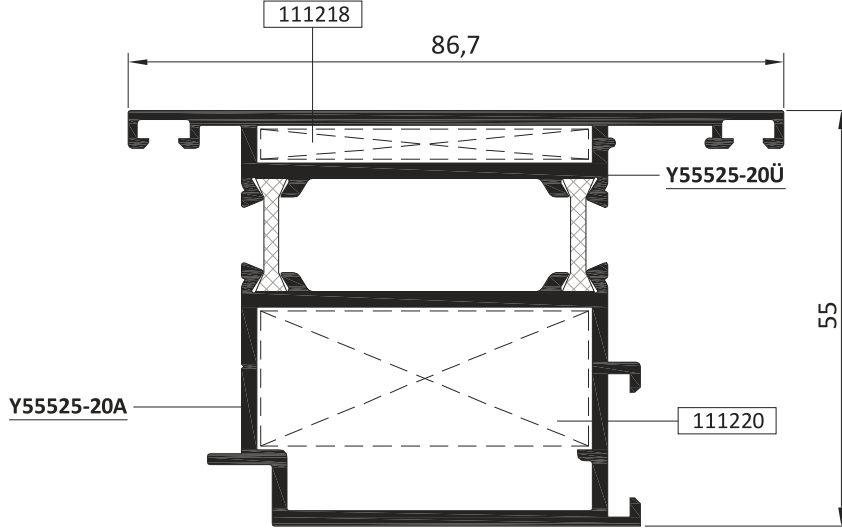
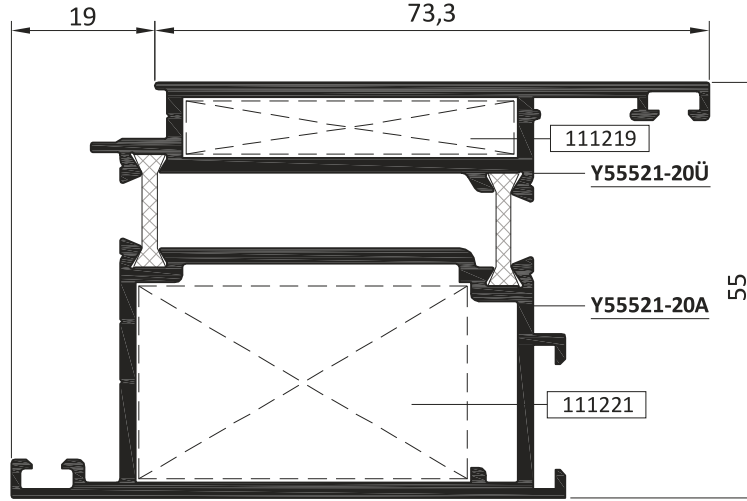
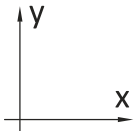
YALITIMLI SİSTEM PROFİLLERİ
INSULATED SYSTEM PROFILES**Y55525-20****Y55521-20**

PROFİL NUMARASI PROFILE NO.	Jx (cm ⁴)	Jy (cm ⁴)	AĞIRLIK WEIGHT (kg/m)
Y55521-20	25,40	43,83	2,058
Y55525-20	26,23	32,01	1,943

YALITIMLI SİSTEM PROFİLLERİ INSULATED SYSTEM PROFILES

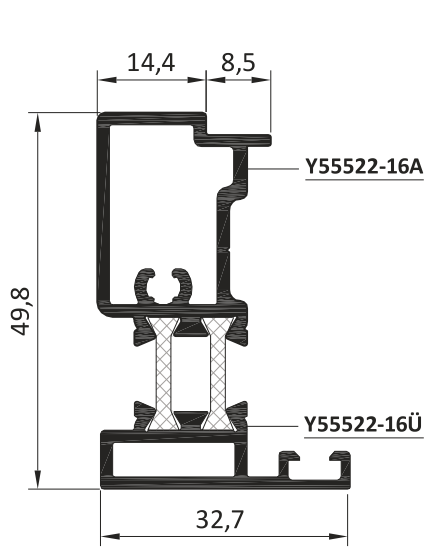

Y55522-16

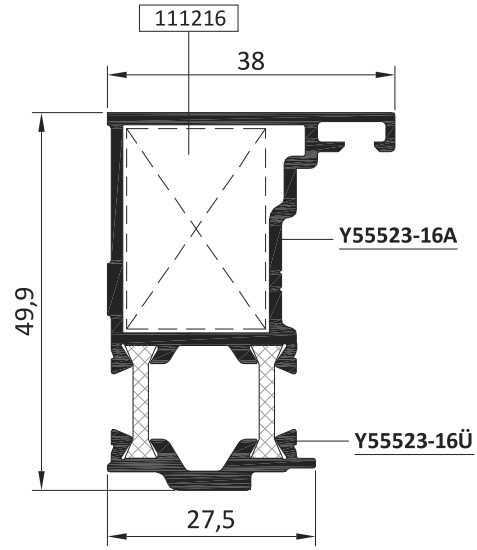

Y55523-16

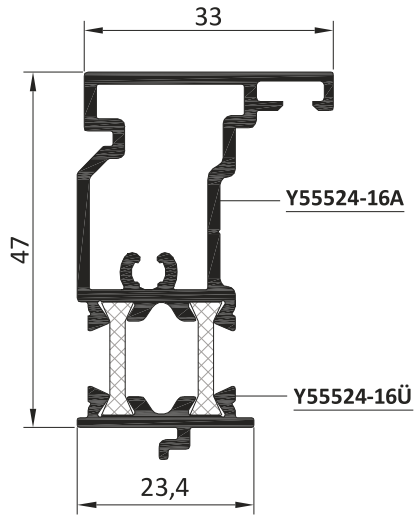

Y55524-16

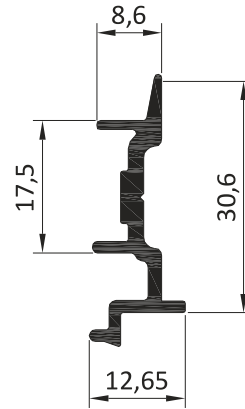

Y55526

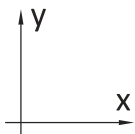

PROFİL NUMARASI PROFILE NO.	Jx (cm ⁴)	Jy (cm ⁴)	AĞIRLIK WEIGHT (kg/m)
Y55522-16	9,31	2,03	0,958
Y55523-16	11,28	3,60	0,960
Y55524-16	9,89	2,38	0,932
Y55526	-	-	0,299

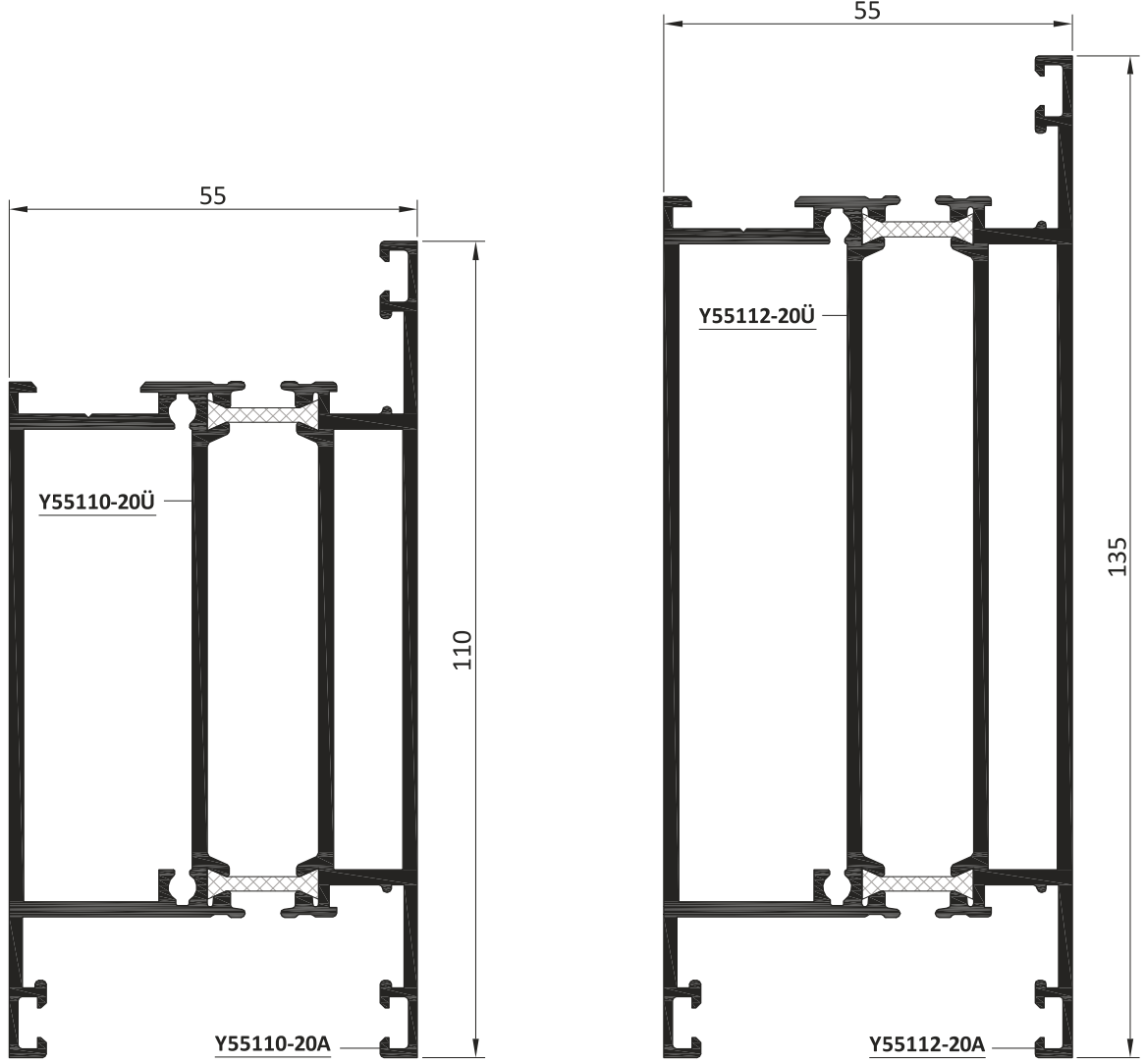
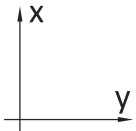
YALITIMLI SİSTEM PROFİLLERİ
INSULATED SYSTEM PROFILES**Y55110-20****Y55112-20**

PROFİL NUMARASI PROFILE NO.	Jx (cm ⁴)	Jy (cm ⁴)	AĞIRLIK WEIGHT (kg/m)
Y55110-20	35,53	73,14	2,443
Y55112-20	43,51	144,90	3,095

YALITIMLI SİSTEM PROFİLLERİ

INSULATED SYSTEM PROFILES



Y55115-20

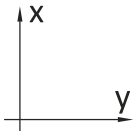

PROFİL NUMARASI PROFILE NO.	Jx (cm ⁴)	Jy (cm ⁴)	AĞIRLIK WEIGHT (kg/m)
Y55115-20	56,27	333,92	3,962

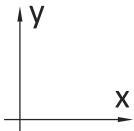
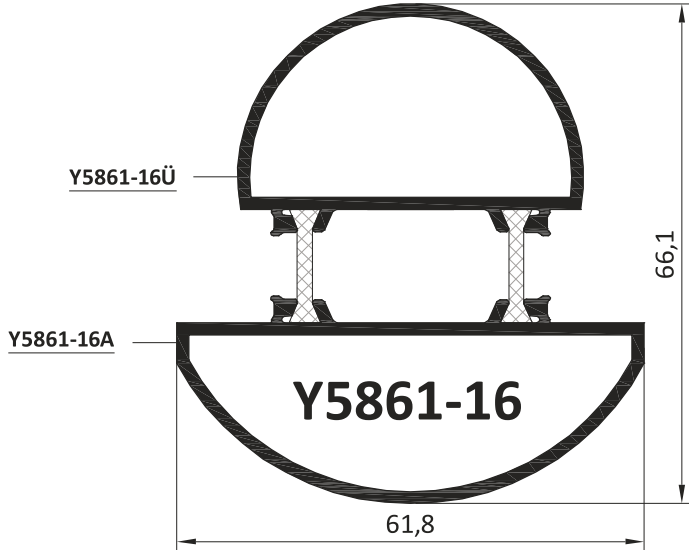
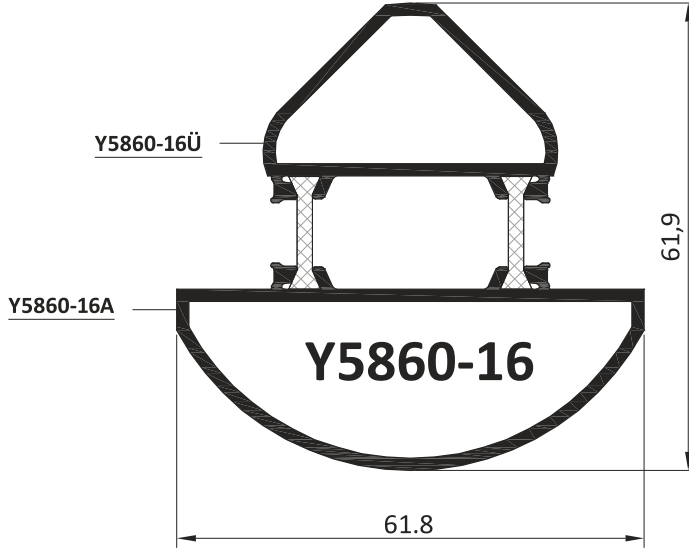
KÖŞE DÖNÜŞ PROFİLLERİ
CORNER PROFILES

PROFİL NUMARASI PROFILE NO.	Jx (cm ⁴)	Jy (cm ⁴)	AĞIRLIK WEIGHT (kg/m)
Y5860-16	14,60	13,27	1,290
Y5861-16	17,05	15,36	1,390

YALITIMSIZ SİSTEM PROFİLLERİ UNINSULATED SYSTEM PROFILES

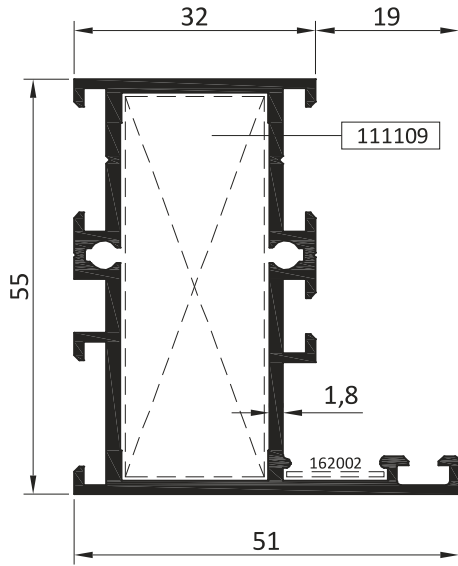

S54012-18

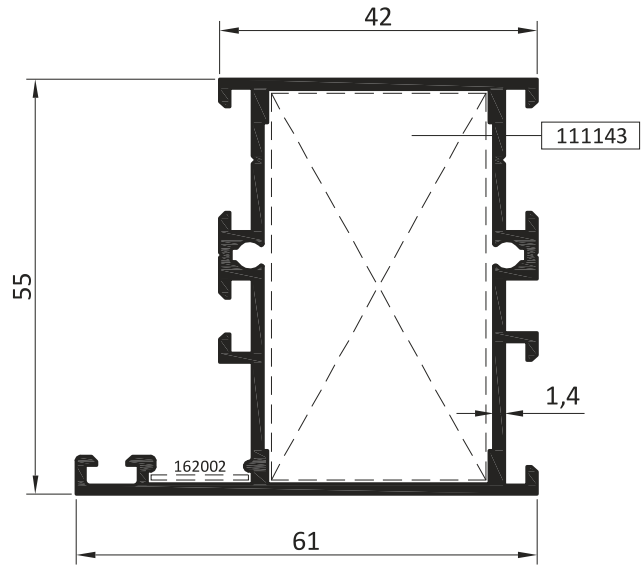

S54020-14

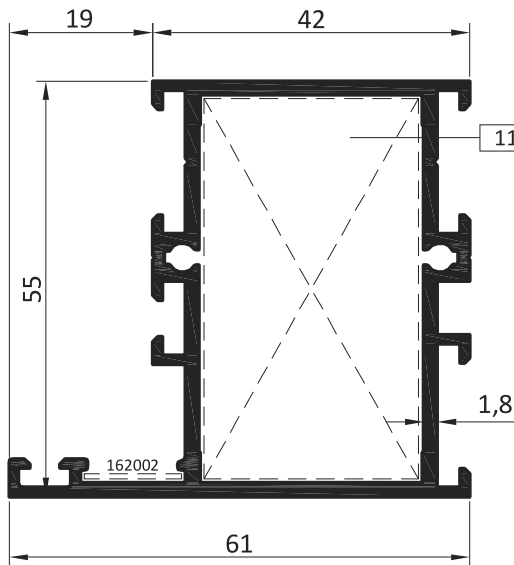

S54020-18

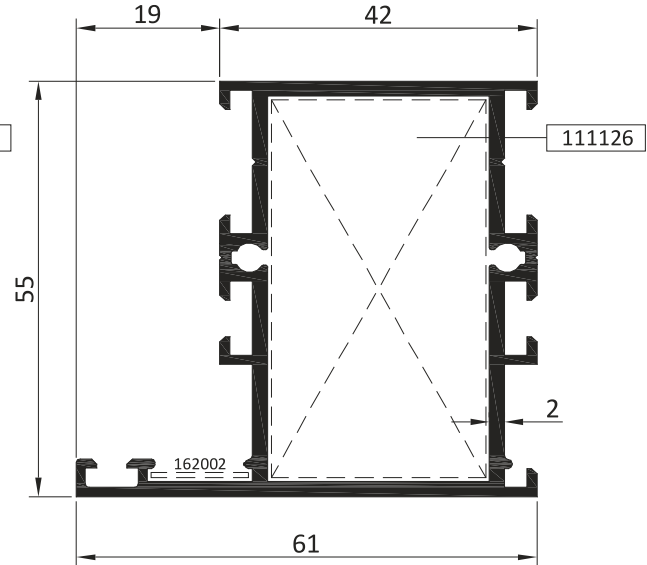

S54020-20

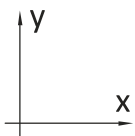

PROFİL NUMARASI PROFILE NO.	Jx (cm ²)	Jy (cm ²)	AĞIRLIK WEIGHT (kg/m)
S54012-18	15,25	7,14	1,084
S54020-14	16,92	10,23	1,014
S54020-18	17,82	12,96	1,181
S54020-20	18,88	13,43	1,265

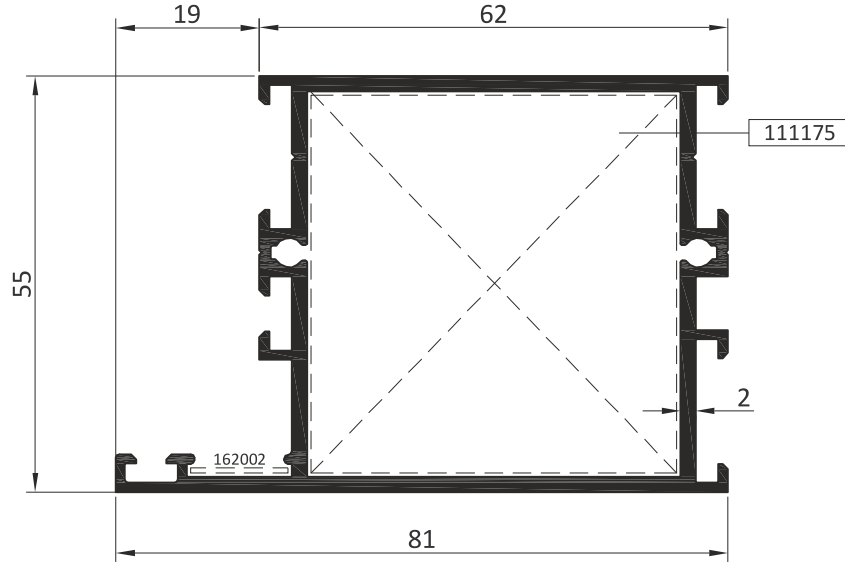
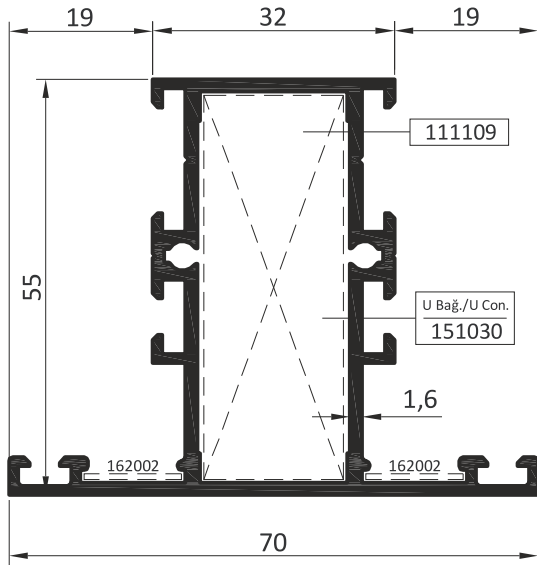
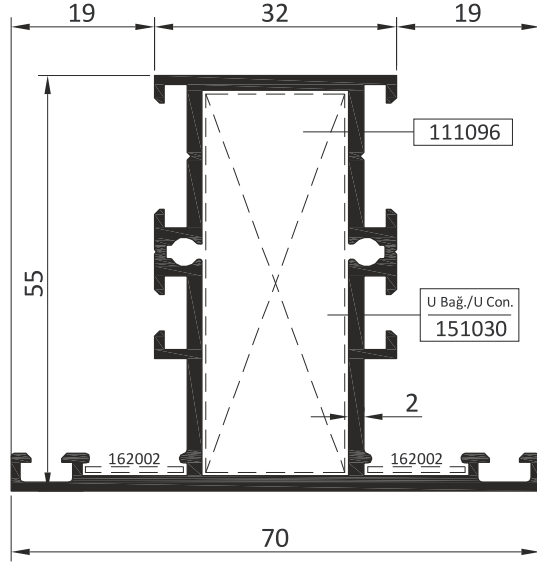
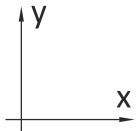
YALITIMSIZ SİSTEM PROFİLLERİ
UNINSULATED SYSTEM PROFILES**S54030-20****S54202-16****S54202-20**

PROFİL NUMARASI PROFILE NO.	Jx (cm ⁴)	Jy (cm ⁴)	AĞIRLIK WEIGHT (kg/m)
S54030-20	24,68	32,98	1,482
S54202-16	16,28	10,22	1,127
S54202-20	18,41	10,94	1,288

YALITIMSIZ SİSTEM PROFİLLERİ UNINSULATED SYSTEM PROFILES

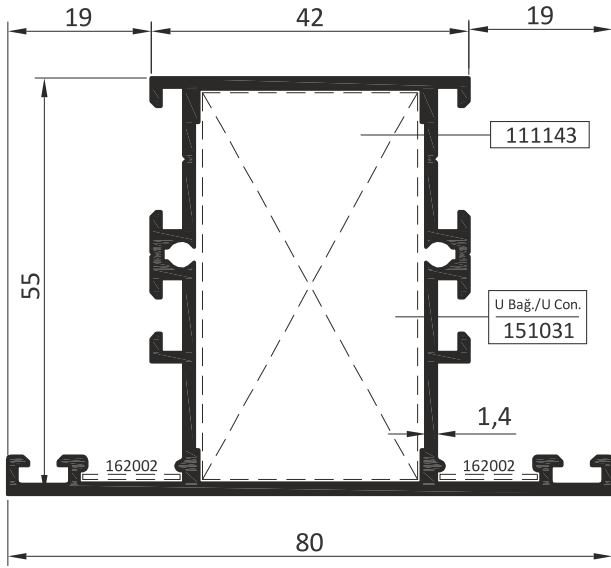

S54210-14

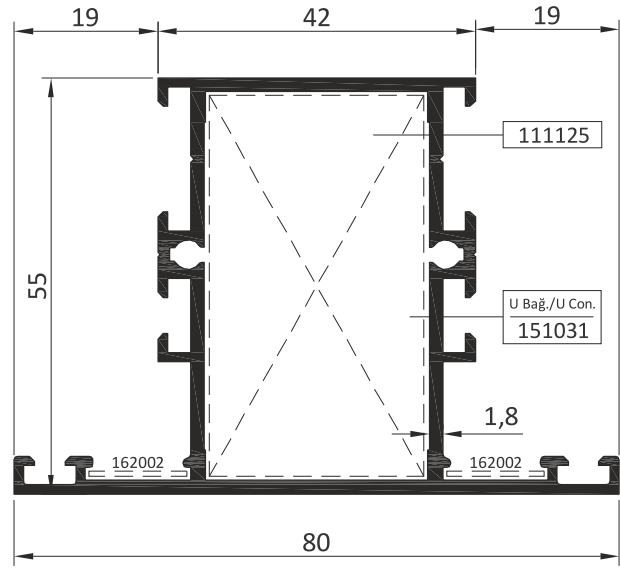

S54210-18

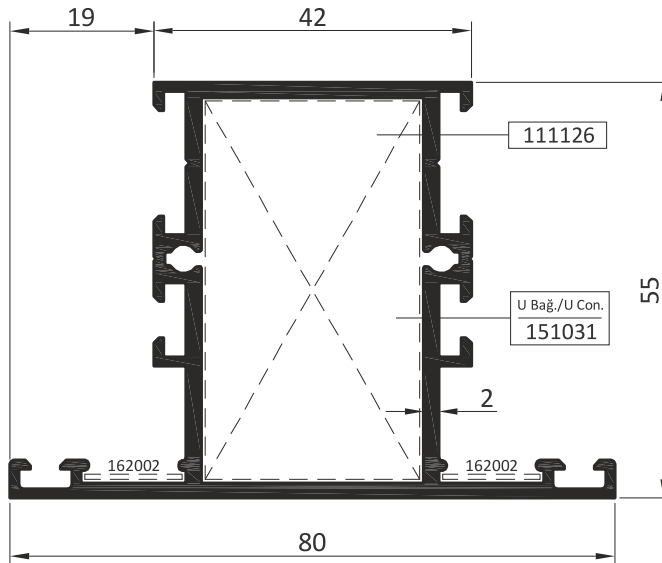

S54210-20

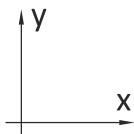

PROFİL NUMARASI PROFILE NO.	Jx (cm ⁴)	Jy (cm ⁴)	AĞIRLIK WEIGHT (kg/m)
S54210-14	17,27	16,28	1,124
S54210-18	19,98	17,77	1,306
S54210-20	21,30	18,51	1,396

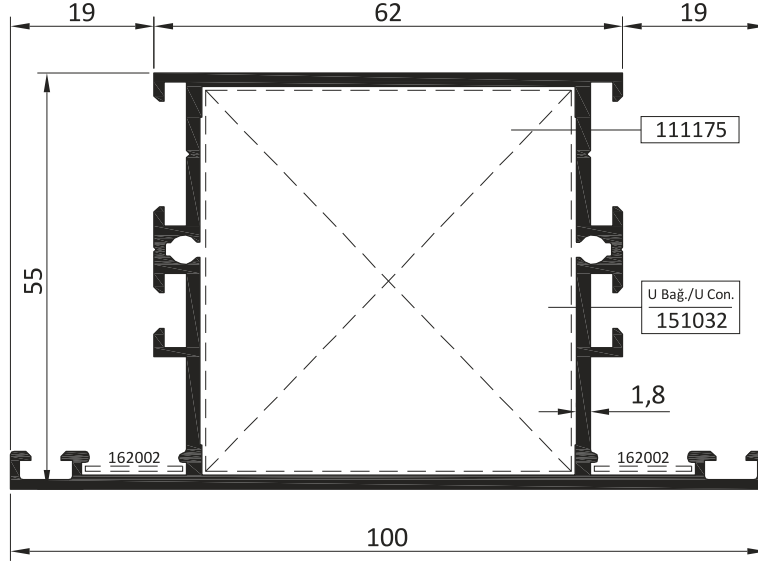
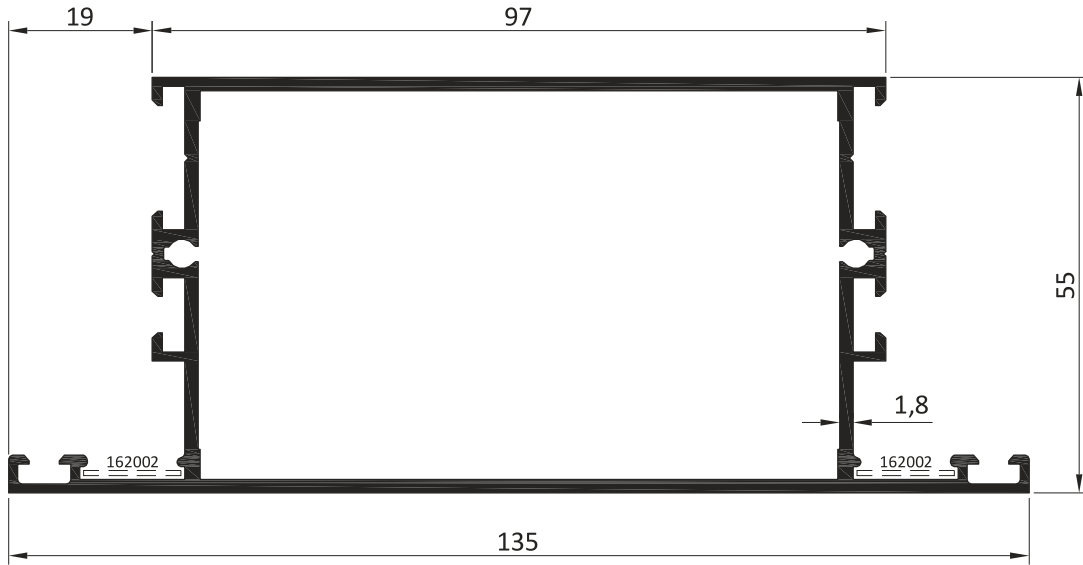
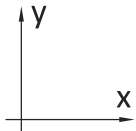
YALITIMSIZ SİSTEM PROFİLLERİ
UNINSULATED SYSTEM PROFILES**S54220-20****S54240-20**

PROFİL NUMARASI PROFILE NO.	Jx (cm ⁴)	Jy (cm ⁴)	AĞIRLIK WEIGHT (kg/m)
S54220-20	27,07	41,56	1,614
S54240-20	37,08	111,52	1,993

YALITIMSIZ SİSTEM PROFİLLERİ UNINSULATED SYSTEM PROFILES

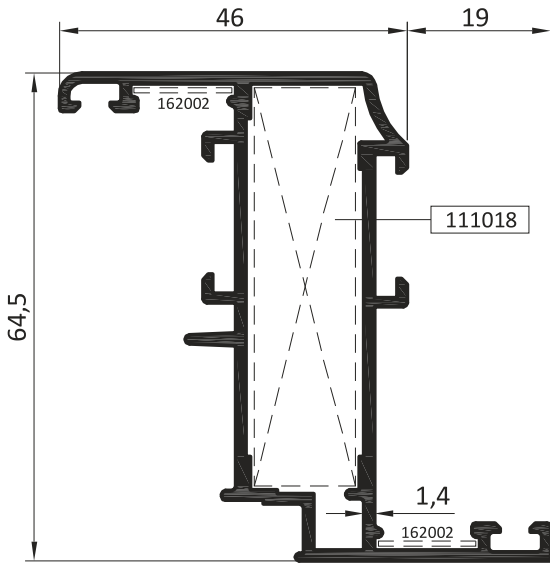

S54340-14

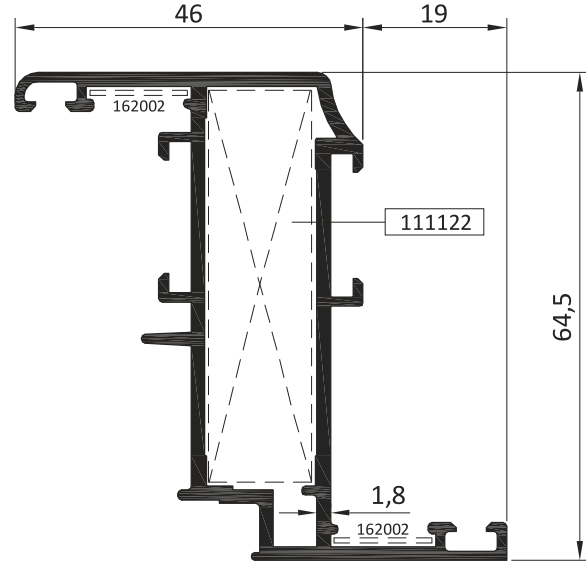

S54340-18

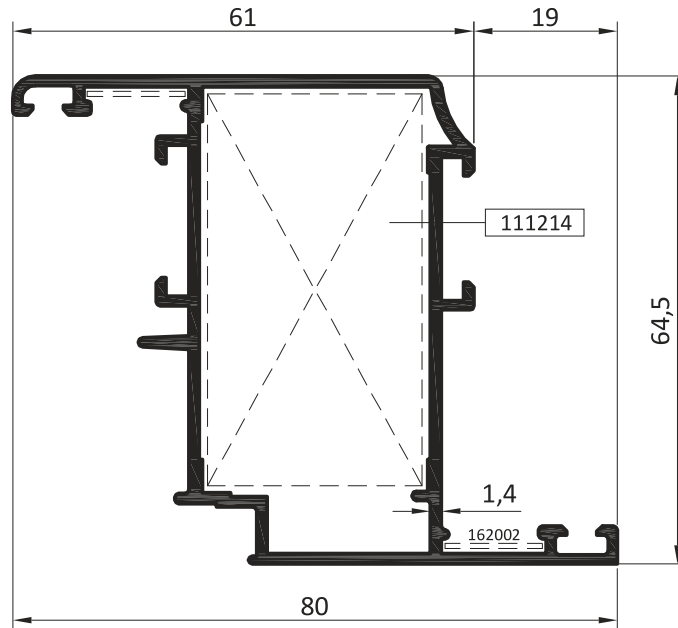

S54350-14

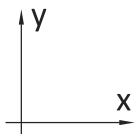

PROFİL NUMARASI PROFILE NO.	Jx (cm ⁴)	Jy (cm ⁴)	AĞIRLIK WEIGHT (kg/m)
S54340-14	23,00	4,45	1,020
S54340-18	26,18	4,97	1,198
S54350-14	29,49	10,38	1,122

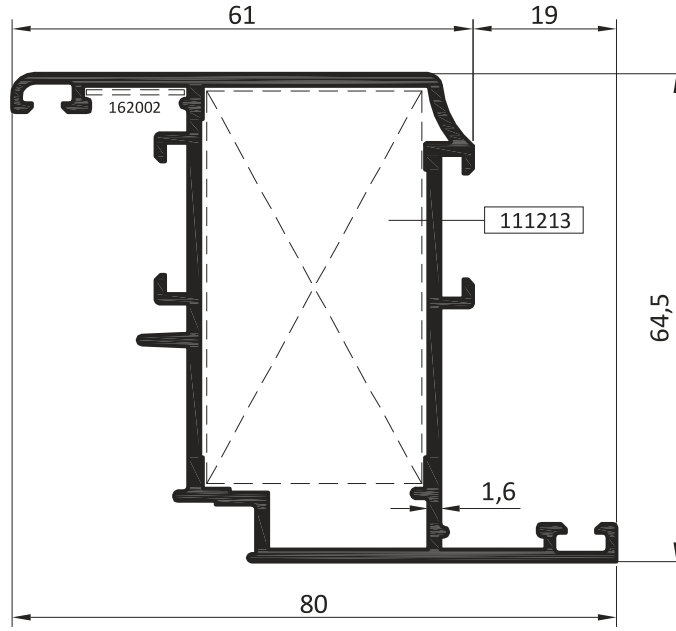
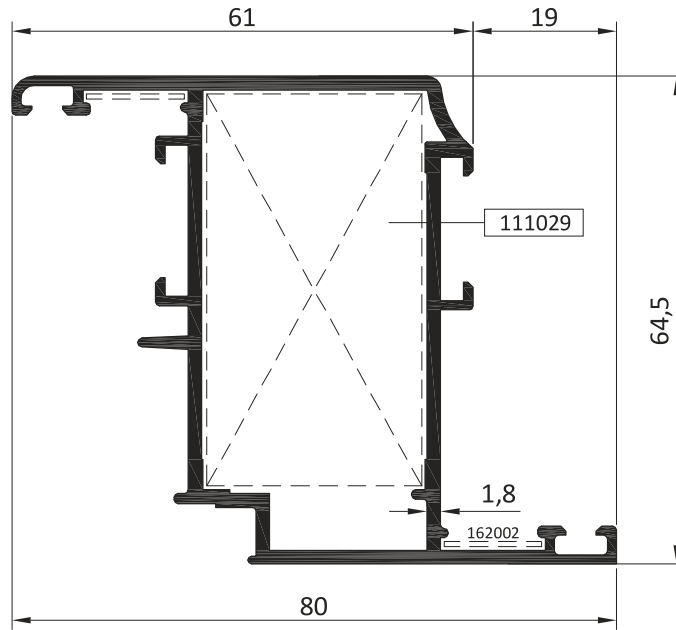
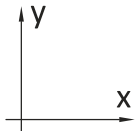
YALITIMSIZ SİSTEM PROFİLLERİ
UNINSULATED SYSTEM PROFILES**S54350-16****S54350-18**

PROFİL NUMARASI PROFILE NO.	Jx (cm ⁴)	Jy (cm ⁴)	AĞIRLIK WEIGHT (kg/m)
S54350-16	31,88	11,35	1,236
S54350-18	34,01	12,23	1,344

YALITIMSIZ SİSTEM PROFİLLERİ UNINSULATED SYSTEM PROFILES

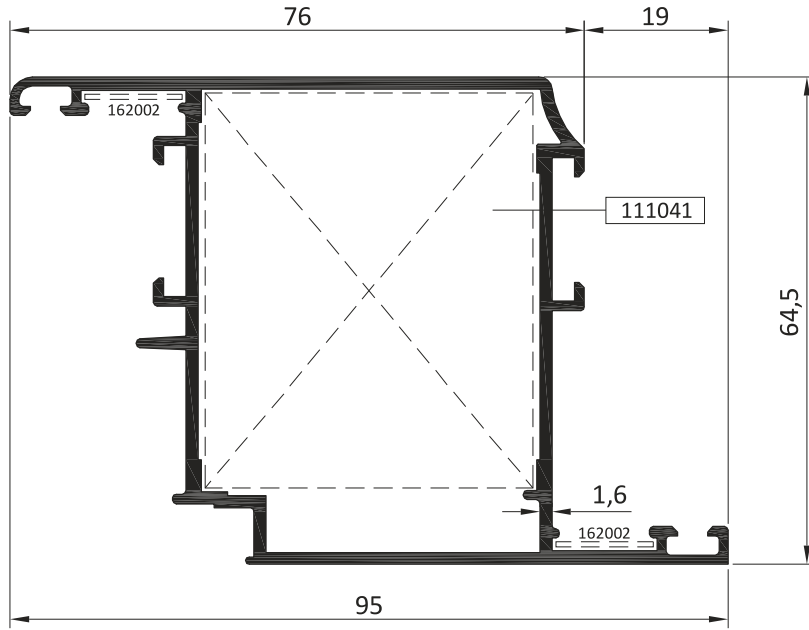

S54360-16

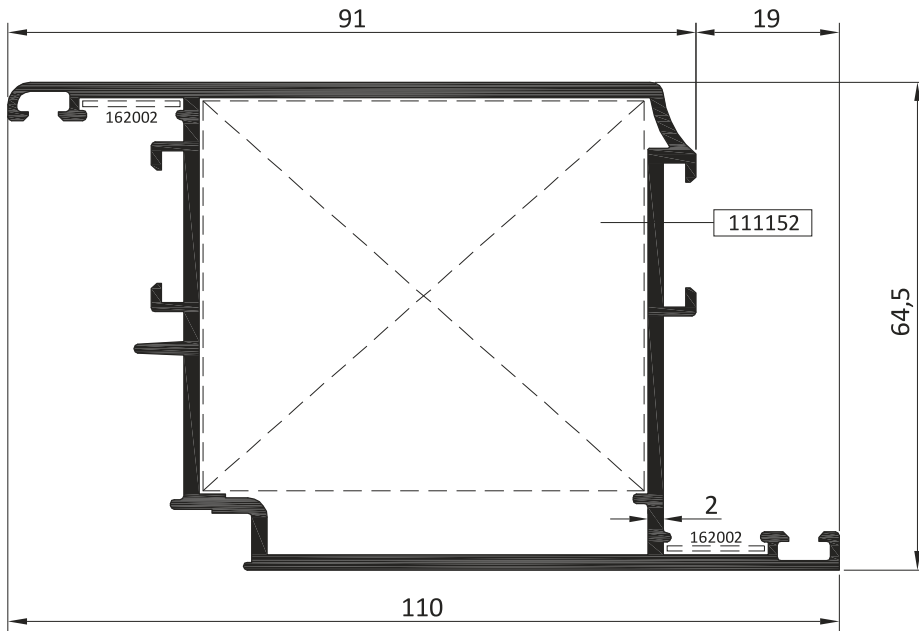

S54371-20

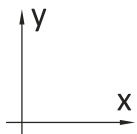

PROFİL NUMARASI PROFILE NO.	Jx (cm ²)	Jy (cm ²)	AĞIRLIK WEIGHT (kg/m)
S54360-16	43,22	20,15	1,384
S54371-20	66,35	33,53	1,765

YALITIMSIZ SİSTEM PROFİLLERİ
UNINSULATED SYSTEM PROFILES

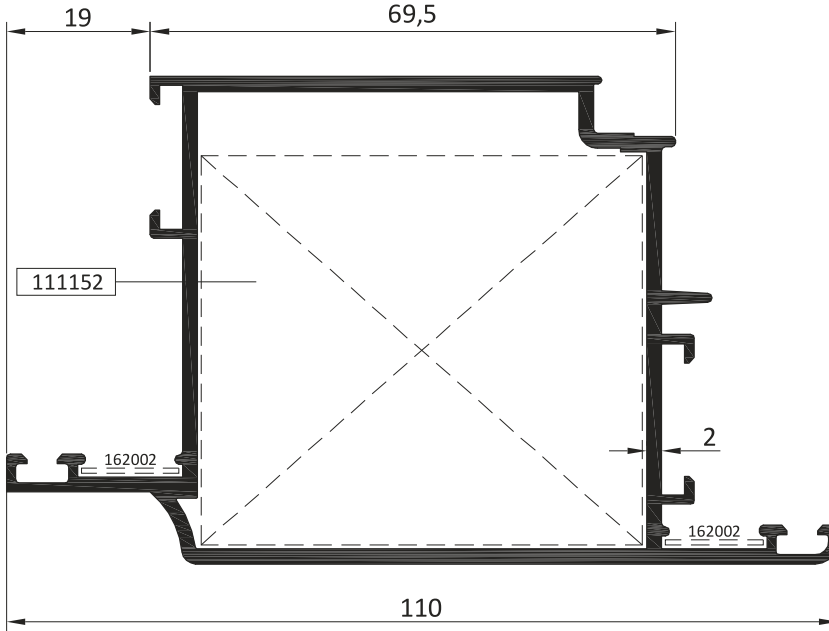
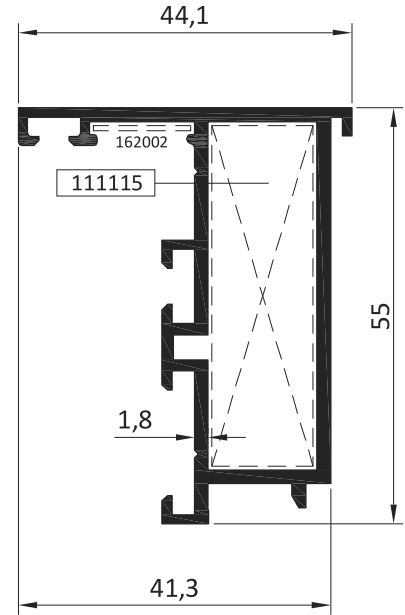
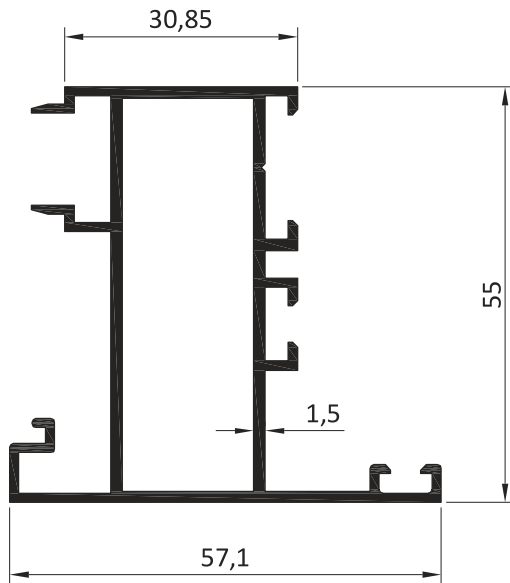
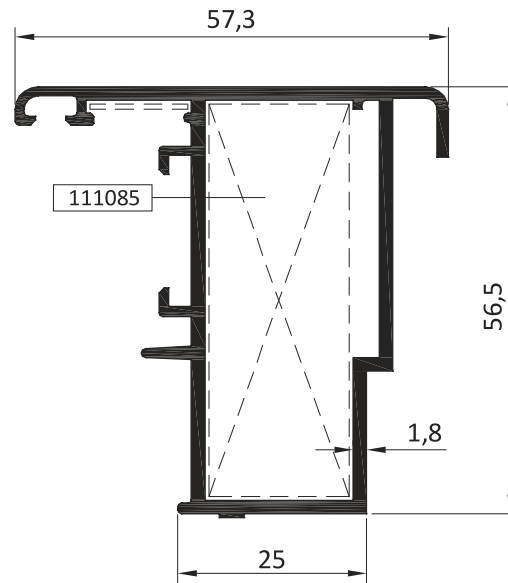
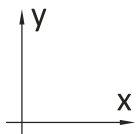
**S54390-20****S54510-18****S54500-15****S54520-18**

PROFİL NUMARASI PROFILE NO.	Jx (cm ⁴)	Jy (cm ⁴)	AĞIRLIK WEIGHT (kg/m)
S54390-20	58,03	38,29	1,759
S54500-15	11,85	3,55	0,978
S54510-18	14,62	6,52	0,913
S54520-18	16,06	7,49	1,056

YALITIMSIZ SİSTEM PROFİLLERİ UNINSULATED SYSTEM PROFILES

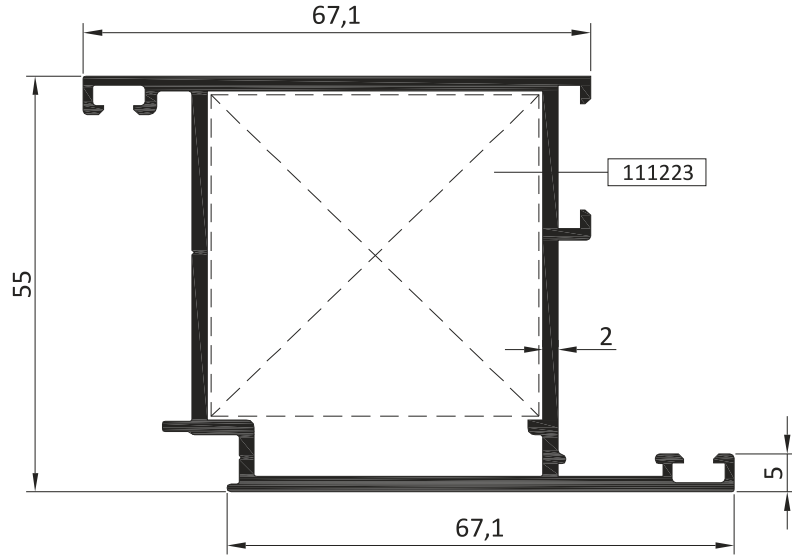

S54701-20

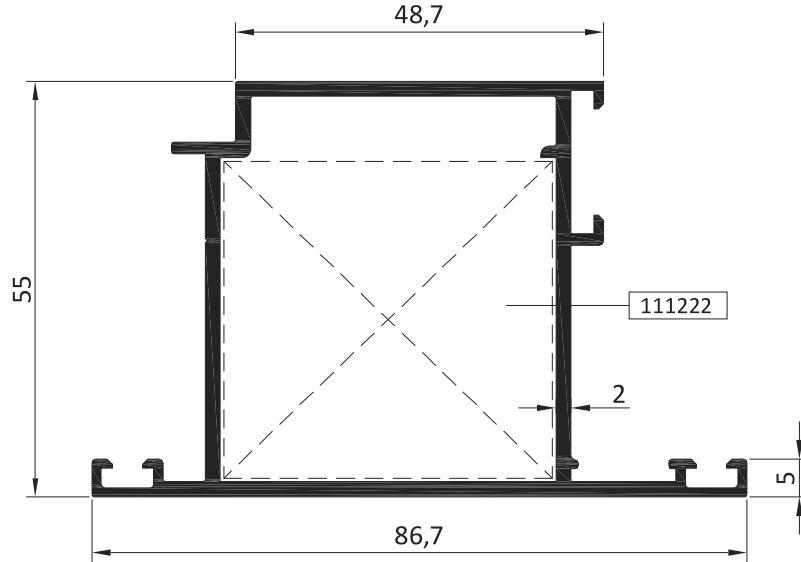

S54705-20

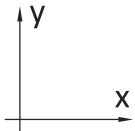

PROFİL NUMARASI PROFILE NO.	Jx (cm ⁴)	Jy (cm ⁴)	AĞIRLIK WEIGHT (kg/m)
S54701-20	32,95	18,31	1,393
S54705-20	27,23	23,66	1,390

YALITIMSIZ SİSTEM PROFİLLERİ
UNINSULATED SYSTEM PROFILES

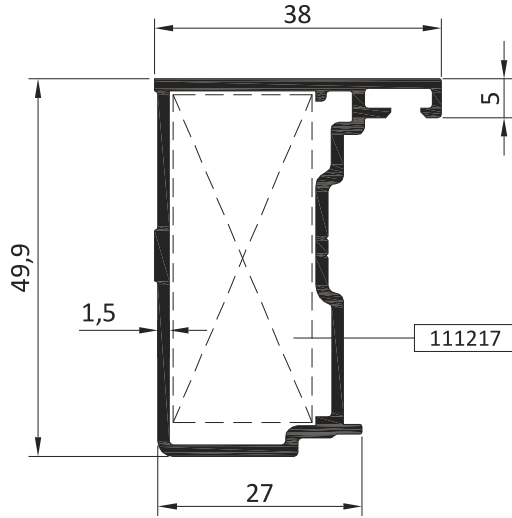
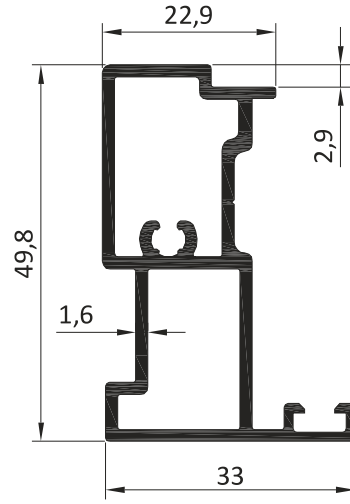
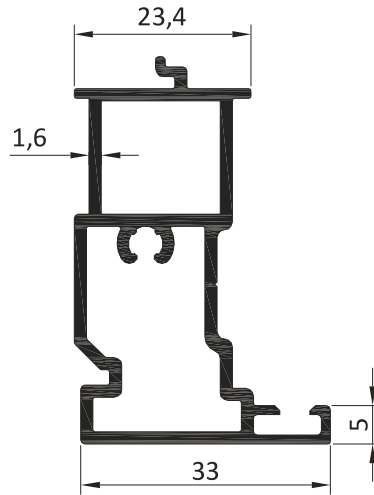
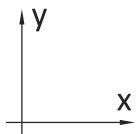
**S54703-15****S54702-16****S54704-16**

PROFİL NUMARASI PROFILE NO.	Jx (cm ⁴)	Jy (cm ⁴)	AĞIRLIK WEIGHT (kg/m)
S54702-16	8,40	2,21	0,820
S54703-15	8,89	3,15	0,719
S54704-16	8,23	2,25	0,835

YALITIMSIZ SİSTEM PROFİLLERİ UNINSULATED SYSTEM PROFILES

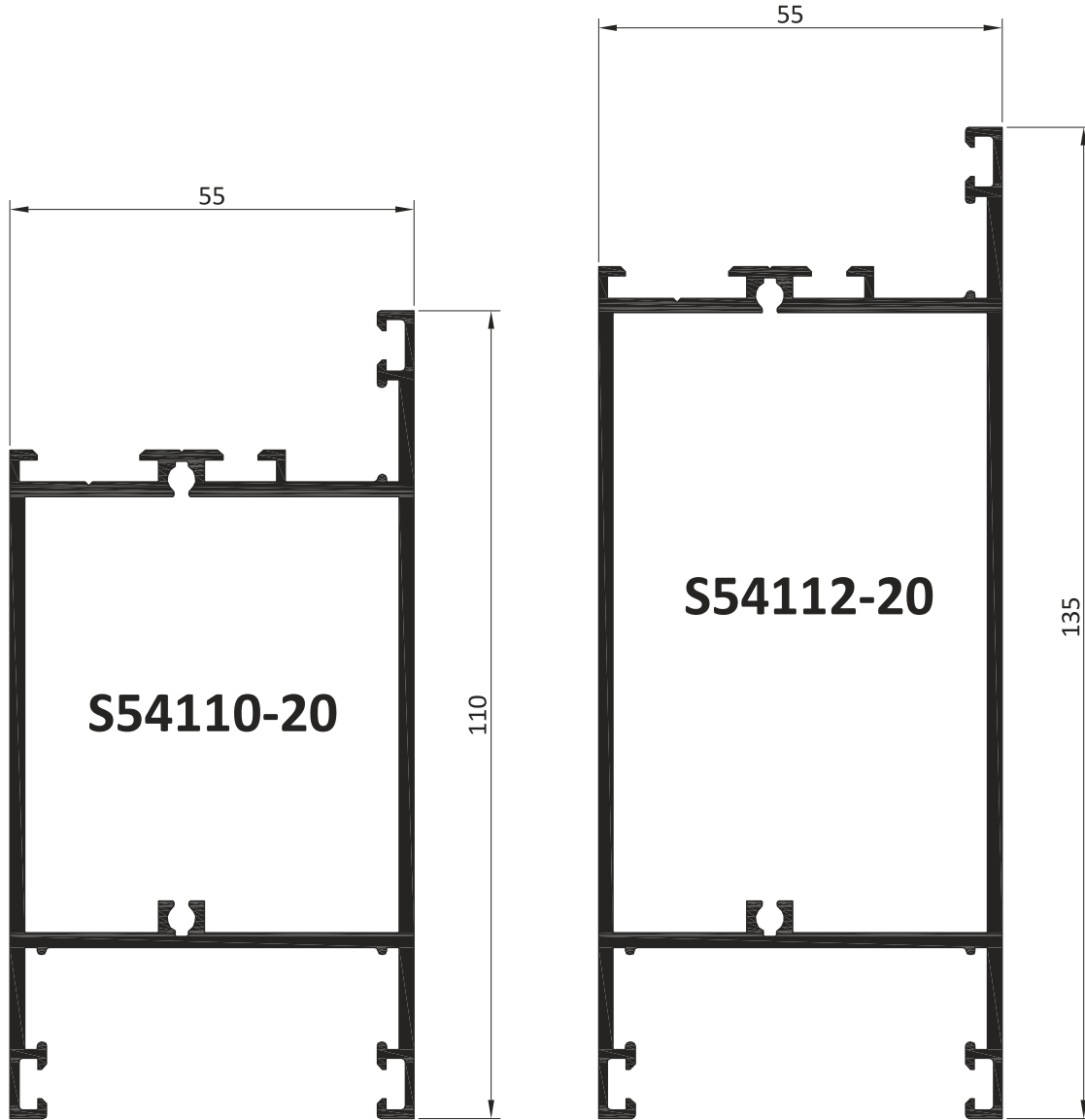

45

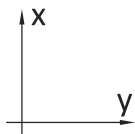

PROFİL NUMARASI PROFILE NO.	Jx (cm ⁴)	Jy (cm ⁴)	AĞIRLIK WEIGHT (kg/m)
S54110-20	32,56	65,36	1,808
S54112-20	39,99	123,10	2,079

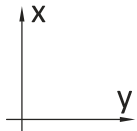
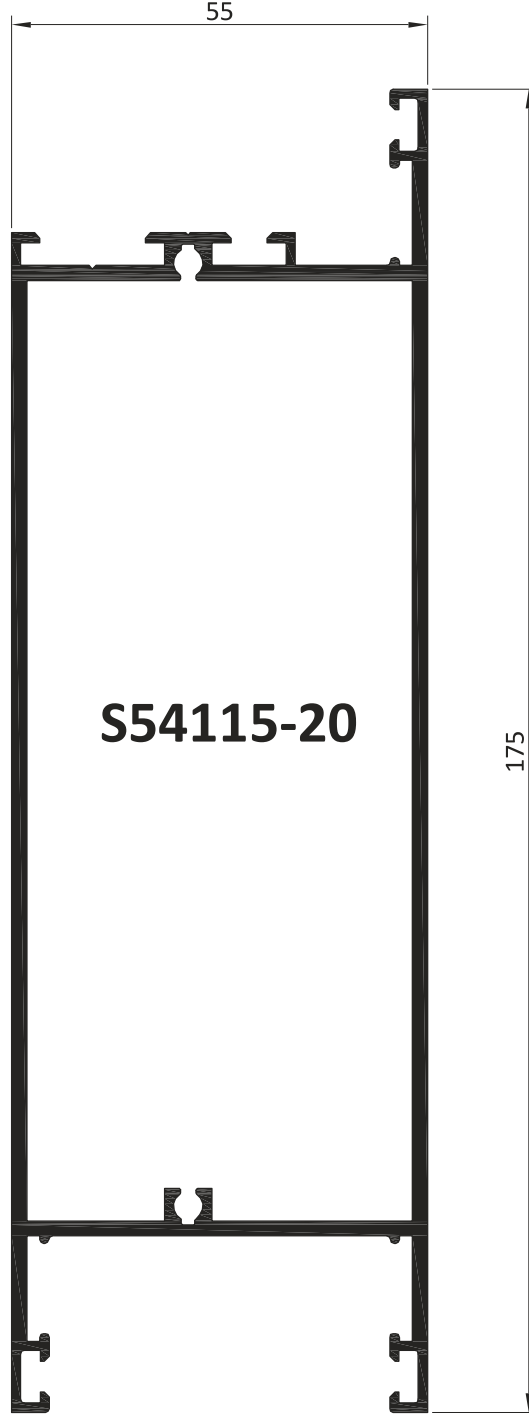
YALITIMSIZ SİSTEM PROFİLLERİ
UNINSULATED SYSTEM PROFILES

PROFİL NUMARASI PROFILE NO.	Jx (cm ⁴)	Jy (cm ⁴)	AĞIRLIK WEIGHT (kg/m)
S54115-20	51,46	267,04	2,512

KÖRKASA T PROFİLLERİ T PROFILES FOR SUBFRAME

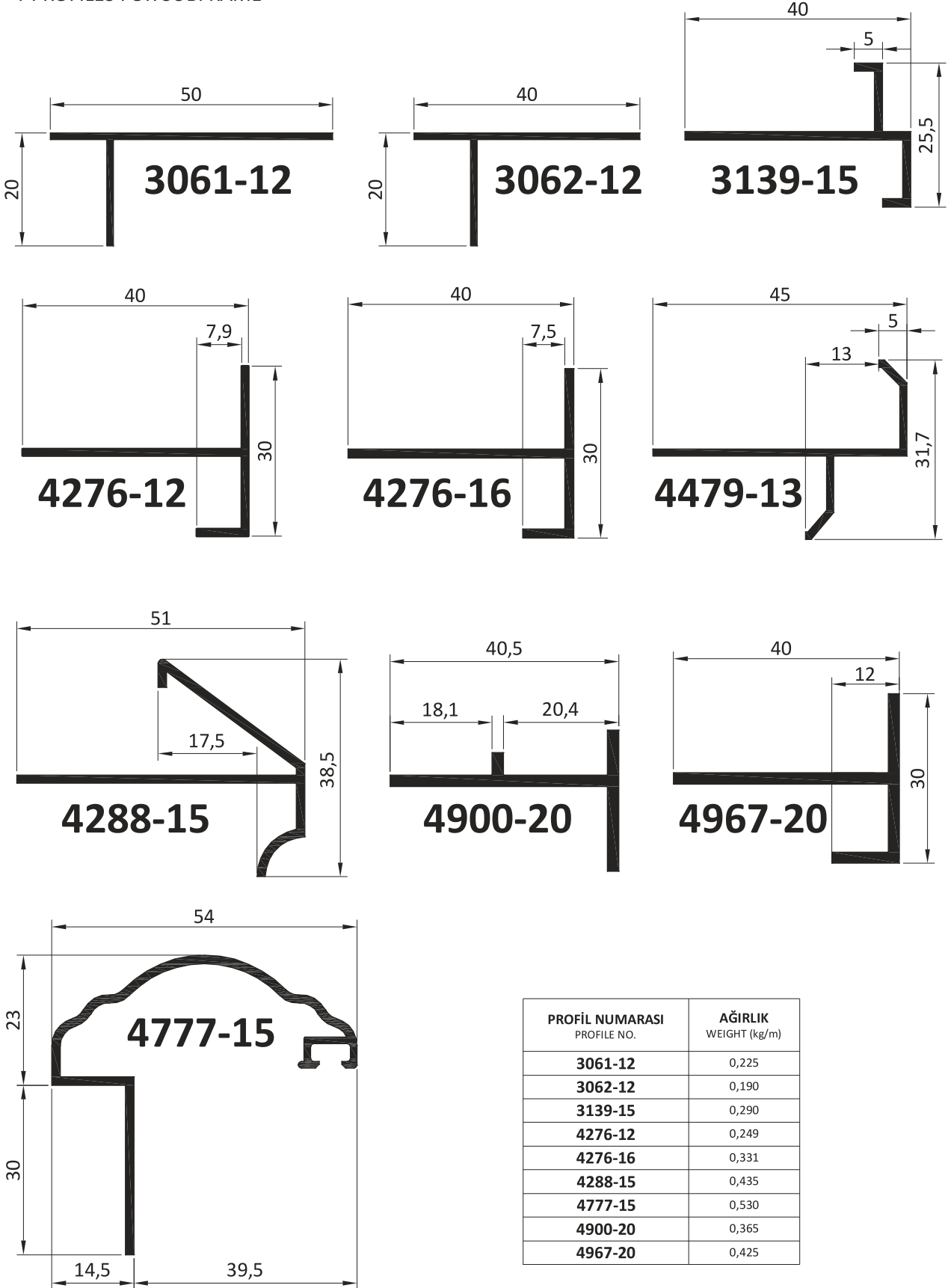

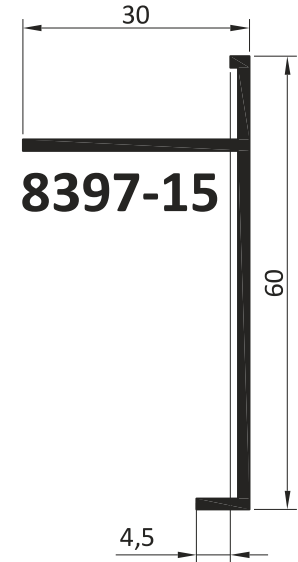
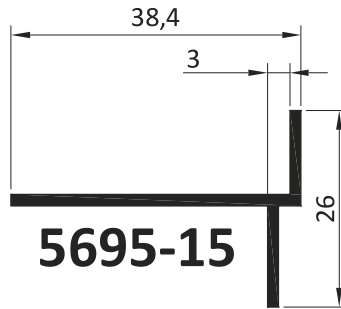
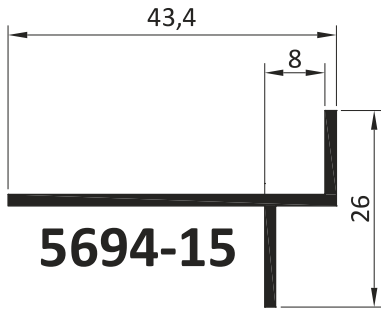
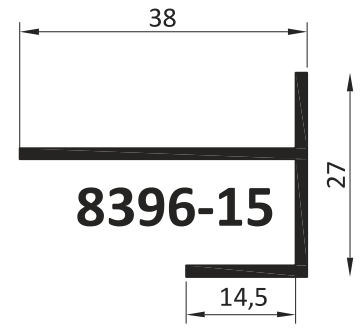
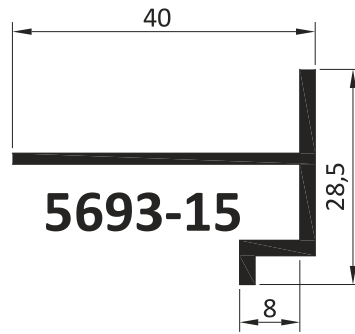
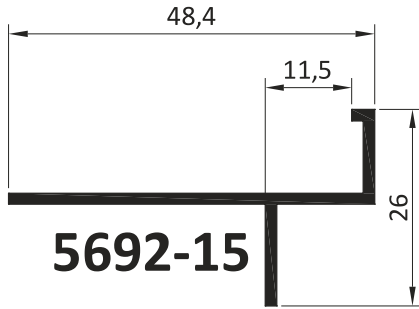
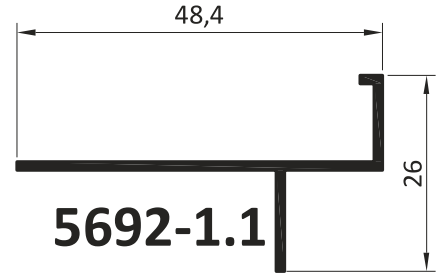
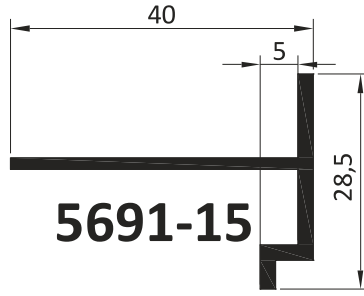
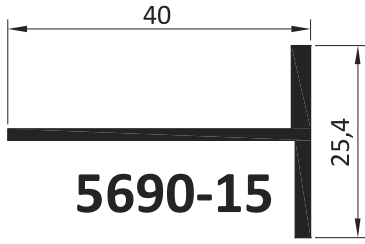
KÖRKASA T PROFİLLERİ
T PROFILES FOR SUBFRAME

PROFİL NUMARASI PROFILE NO.	AĞIRLIK WEIGHT (kg/m)
8396-15	0,317
8397-15	0,385
5690-15	0,310
5691-15	0,335
5692-1.1	0,205
5692-15	0,300
5693-15	0,355
5694-15	0,280
5695-15	0,255

LAMBRI PROFİLLERİ PANEL PROFILES

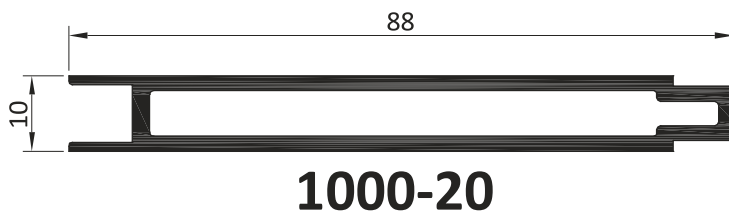
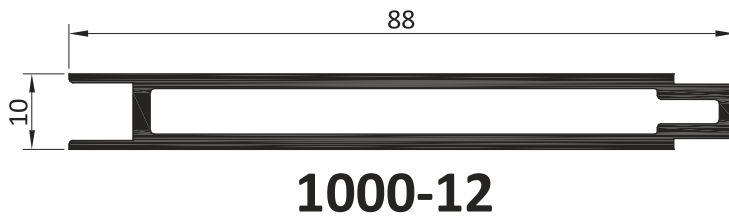
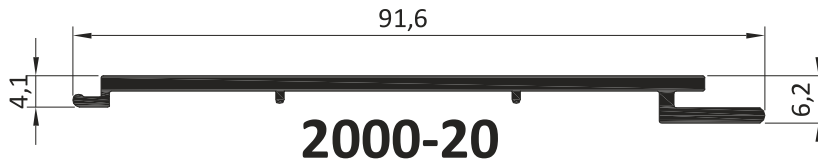
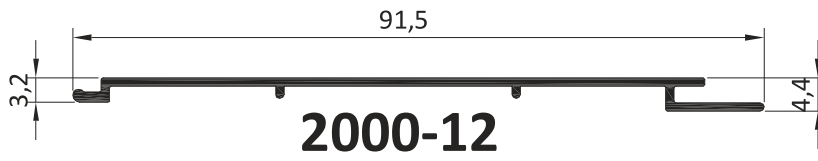
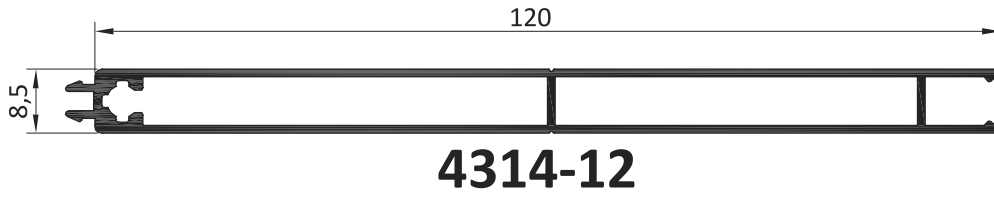
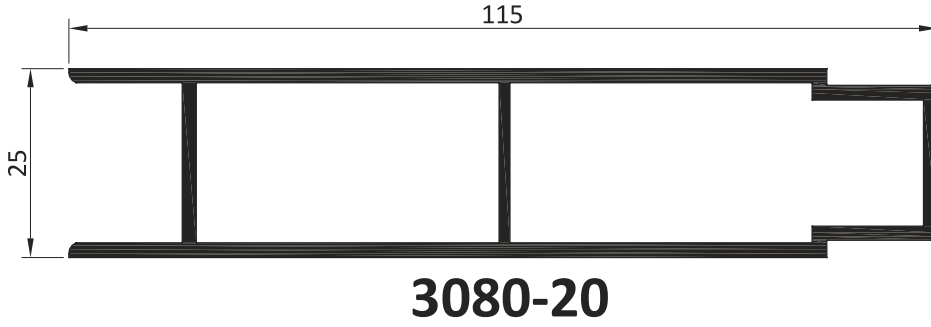

PROFİL NUMARASI PROFILE NO.	AĞIRLIK WEIGHT (kg/m)
1000-12	0,635
1000-20	0,992
2000-12	0,395
2000-20	0,635
3080-20	1,482
4314-12	0,830

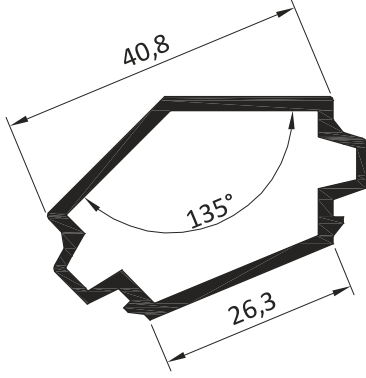
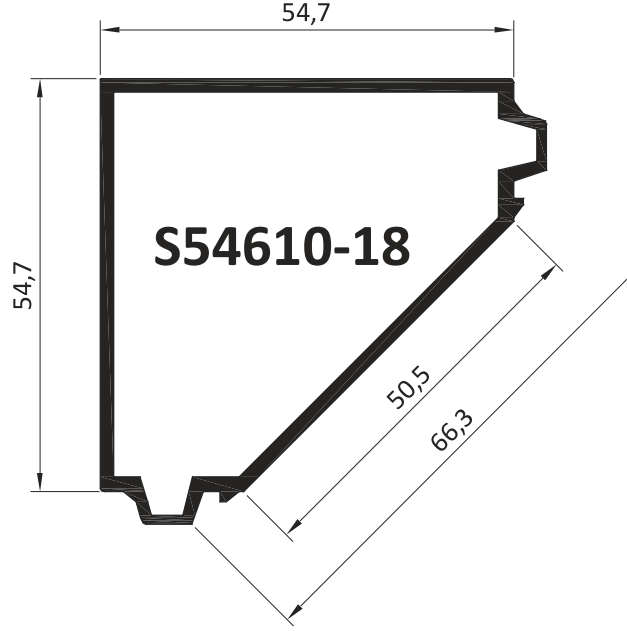
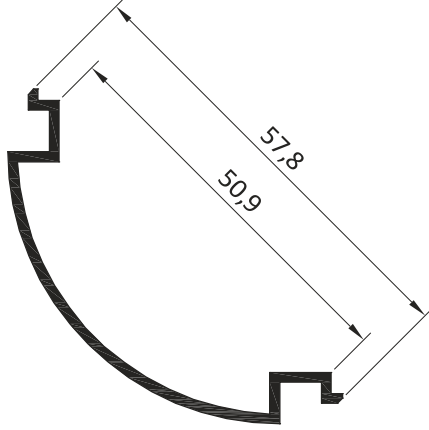
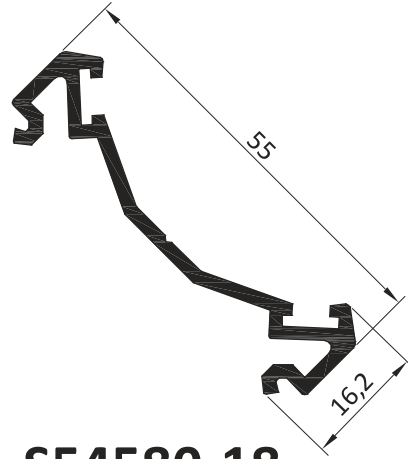
KÖŞE DÖNÜŞ PROFİLLERİ
CORNER PROFILES**S54630-18****S54610-18****S5660-18****S54580-18**

PROFİL NUMARASI PROFILE NO.	AĞIRLIK WEIGHT (kg/m)
S54610-18	0,996
S54630-18	0,567
S5660-18	0,310
S54580-18	0,510

ALÜMİNYUM AKSESUAR PROFİLLERİ PROFILES OF ALUMINIUM ACCESSORIES

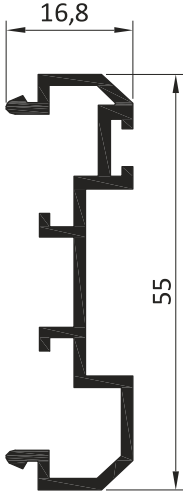

S54560-00

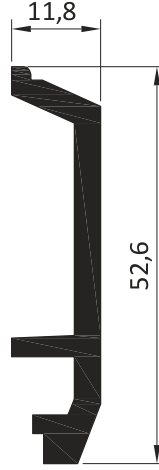

S54700-00

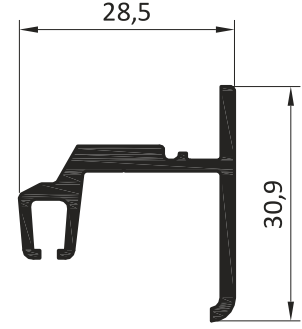

S5614-00

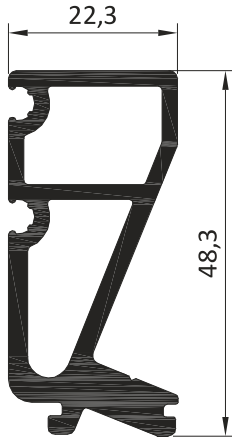

20300

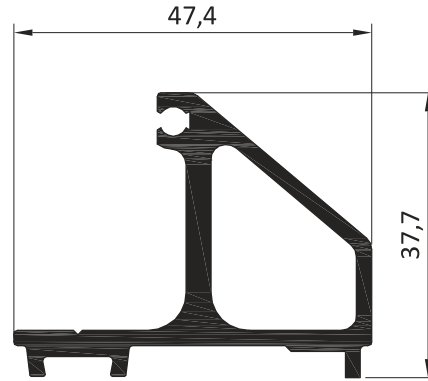

SZ54170-00



S5671-00

PROFİL NUMARASI PROFILE NO.	AĞIRLIK WEIGHT (kg/m)
20300	1,050
S54700-00	1,056
S54560-00	0,492
S5614-00	0,403
S5671-00	0,145
SZ54170-00	0,943

ALÜMİNYUM AKSESUAR PROFİLLERİ
PROFILES OF ALUMINIUM ACCESSORIES

PROFİL NUMARASI PROFILE NO.	AĞIRLIK WEIGHT (kg/m)
5680-14	3,639
5580-19	2,700
5680-24	3,091
5375-15,3	2,535

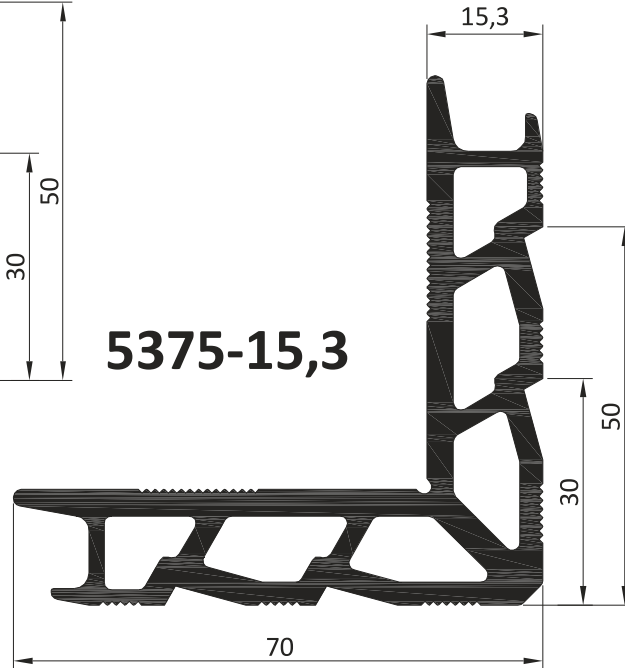
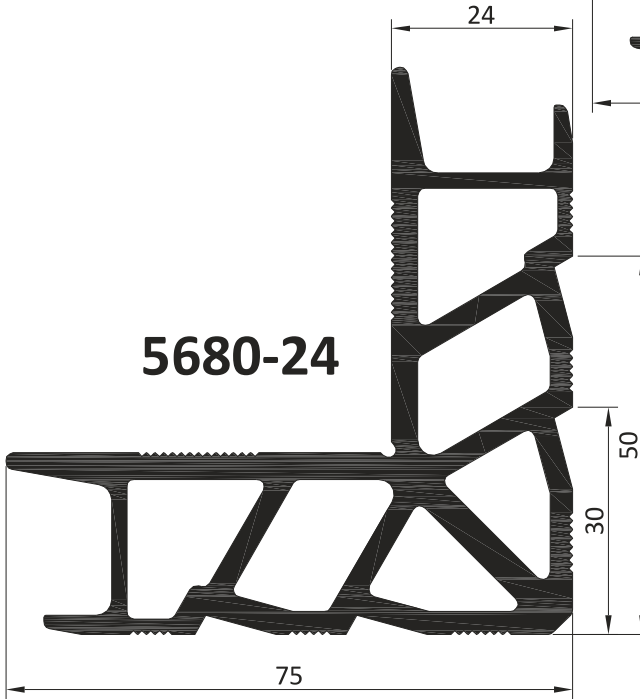
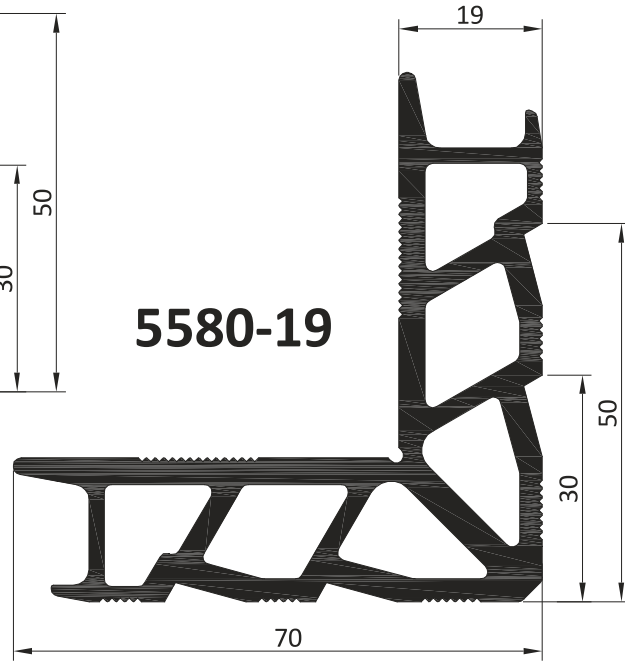
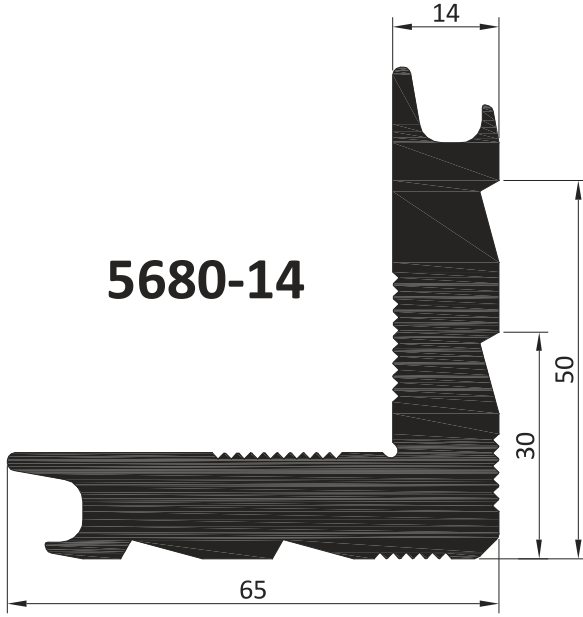

ALÜMİNYUM AKSESUAR PROFİLLERİ

PROFILES OF ALUMINIUM ACCESSORIES

PROFİL NUMARASI PROFILE NO.	AĞIRLIK WEIGHT (kg/m)
5680-29	3,875
5680-44	5,240

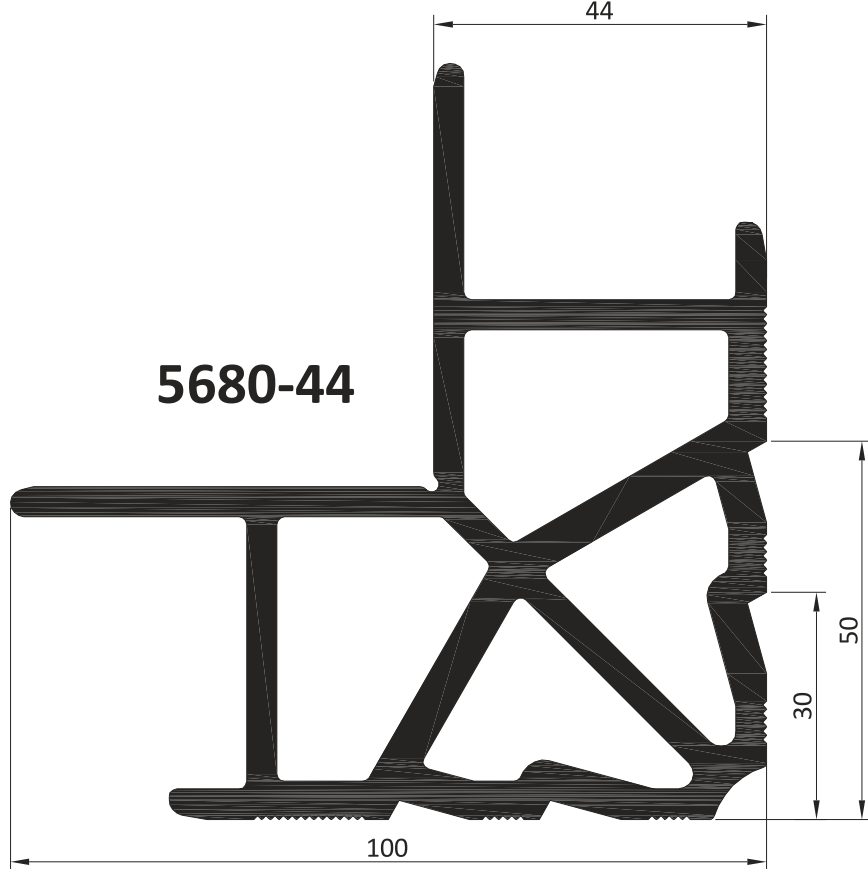
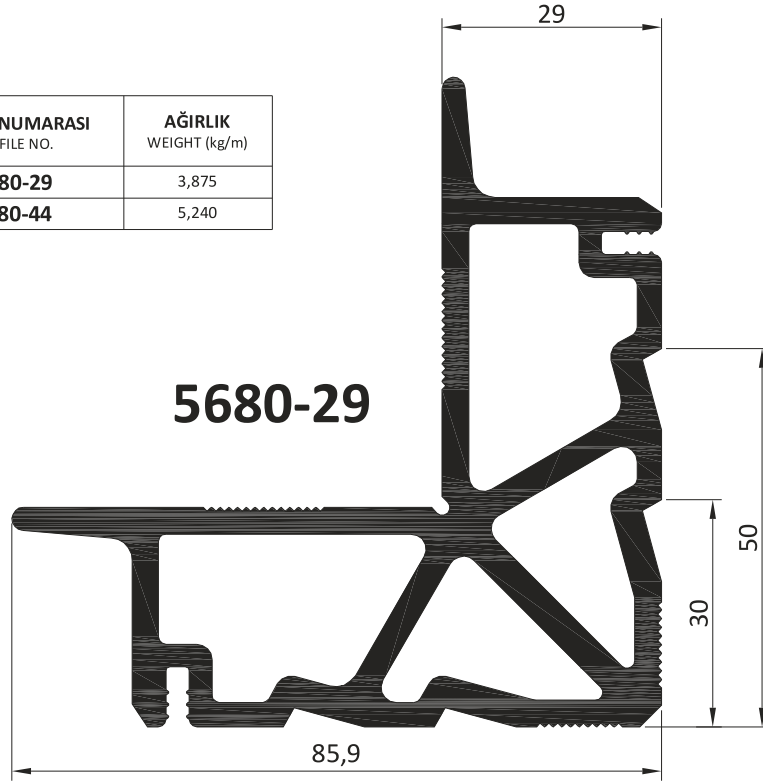

ALÜMİNYUM AKSESUAR PROFİLLERİ
PROFILES OF ALUMINIUM ACCESSORIES

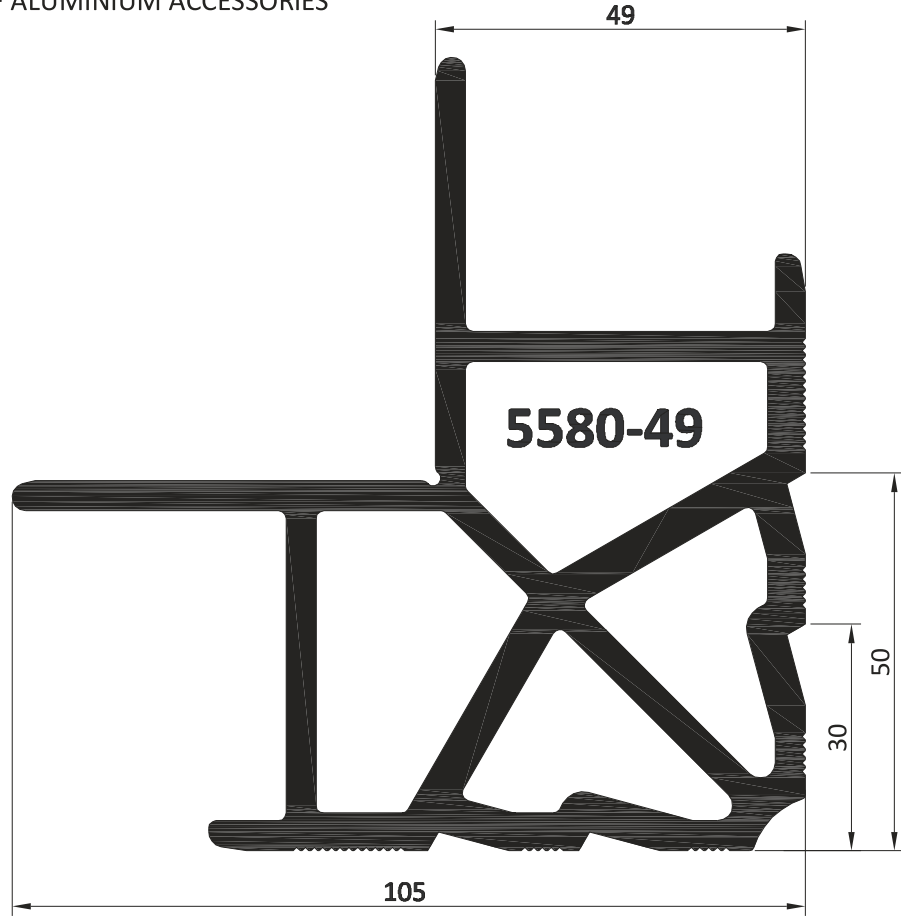

PROFİL NUMARASI PROFILE NO.	AĞIRLIK WEIGHT (kg/m)
5580-49	5,427
5680-59	7,826

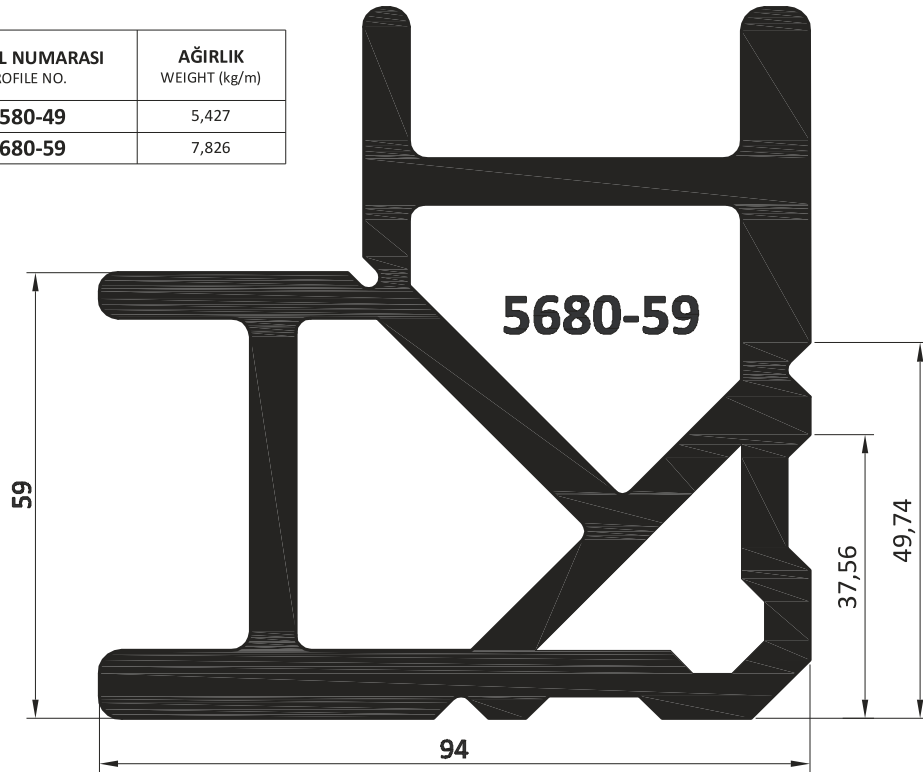

CAM ÇİTALARI

GLAZING BEADS

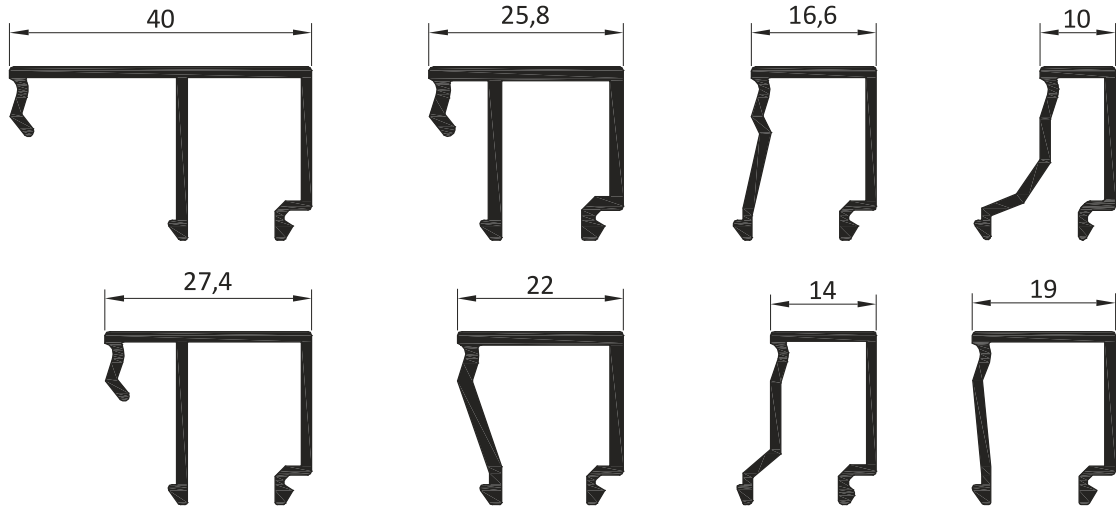

PROFİL NO PROFILE NO	GENİŞLİK WIDHT (mm)	ET KALINLIĞI WALL THICKNESS (mm)	AĞIRLIK WEIGHT (kg)
5647-15	42,9	1,5	0,375
5649-12	40	1,2	0,320
5649-15	40	1,5	0,369
5646-15	37,7	1,5	0,355
7046-14	35,5	1,4	0,344
6500-14	32,7	1,4	0,335
ES4545-13	30,5	1,3	0,306
5645-18	29	1,8	0,410
5644-15	27,4	1,5	0,304
5643-12	25,7	1,2	0,269
5643-15	25,7	1,5	0,309
5643-18	25,7	1,8	0,388
5642-15	22	1,5	0,266
5642-18	22	1,8	0,342
Y55410-15	19	1,5	0,247
5641-15	16,6	1,5	0,245
5641-18	16,6	1,8	0,309
ES4540-13	14	1,3	0,228
5640-15	10	1,5	0,227
5648-15	5,5	1,5	0,220

CAM KALINLIĞINA BAĞLI CAM ÇITASI SEÇİM TABLOSU

GLAZING BEAD SELECTION TABLE ACCORDING TO THE GLASS THICKNESS

5647-15, 5647-18	7.1	42.9
5649-12, 5649-15, 5649-19	10	40
5646-15, 5646-18	12.3	37.7
7046-14	14.5	35.5
6500-14	17.3	32.7
ES4545-13	19.5	30.5
5645-15, 5645-18	21	29
5644-15, 5644-18	22.6	27.4
5643-12, 5643-15, 5643-18	24.3	25.7
5642-15, 5642-18	28	22
Y55410-15	31	19
5641-15, 5641-18	33.4	16.6
ES4540-13	36	14
5640-15	40	10
5648-15	44.5	5.5

** YUKARIDA VERİLEN PROFİL VE FİTİL İLİŞKİLERİ TEORİKTİR.

THE RELATION BETWEEN PROFILES & GASKETS ARE THEORETICAL AS SEEN ABOVE.

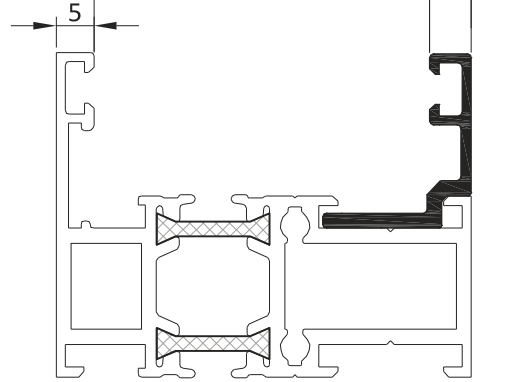
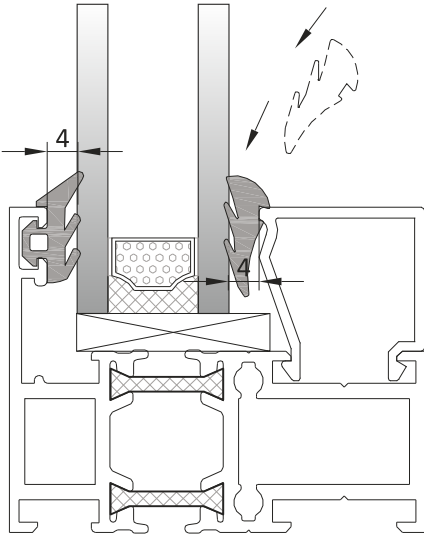

DIŞ FİTİLLER STANDART EBATTA OLUP 4mm KALINLIĞINDADIR. İÇTEKİ KAMA FİTİLİN BOŞLUĞU İSE, MÜMKÜNSE MİNİMUM 3mm OLACAK ŞEKİLDE AYARLANMALIDIR.

THE OUTER GASKET'S DIMENSION ARE STANDARD WITH 4mm THICKNESS. IF IT'S POSSIBLE, THE INNER GASKET'S SPACE ADJUSTED MINIMUM 3mm.

CAM VE PROFİL TOLERANSLARI + VEYA - YÖNDE BERABER ÇALIŞARAK TEORİDE OLMASI GEREKENDEN BÜYÜK VEYA KÜÇÜK BİR FİTİL BOŞLUĞUNA NEDEN OLABİLİR.

THE GLASS AND THE PROFILE TOLERANCES CAN BE WORK AT + OR - DIRECTION TOGETHER. IT CAUSES THE GASKET'S SPACE BIGGER OR SMALLER THAN NORMAL.

İÇ KAMA FİTİLLERİN YERİNE GEÇMESİNDE PROBLEM YAŞANMAMASI İÇİN, ÖNCELİKLE BİR NUMUNE ÜZERİNDE DENENMESİ TAVSİYE EDERİZ.

WE ADVICE THAT THE INNER GASKET AND GLAZING BEAD RELATION SHOULD BE CHECKED ON A MOCK-UP BEFORE.

DETAYLAR

DETAILS

TARAMA STİLLERİ / HATCH STYLES

- | | |
|---|--|
|  EPDM FİTİL / EPDM GASKET |  PVC PROFİL / PVC PROFILE |
|  STRÜKTÜREL SİLİKON / STRUCTURAL SILICONE |  ÇELİK PROFİL / STEEL PROFILE |
|  MESAFE BELİRLEYİCİ / SPACE ADJUSTER |  SU YALITIM MEMBRANI / WATERPROOFING MEMBRANE |
|  ALÜMİNYUM PROFİL / ALUMINIUM PROFILE |  POLİETİLEN CONTA / POLYETHYLENE GASKET |
|  PROFİL PARÇA (Al) / PIECE OF PROFILE (Al) |  TAŞYÜNÜ / ROCKWOOL |
|  ISI BARIYERİ / INSULATION BAR |  CAM / GLASS |

YALITIMLI SİSTEM DETAYLARI

INSULATED SYSTEM DETAILS

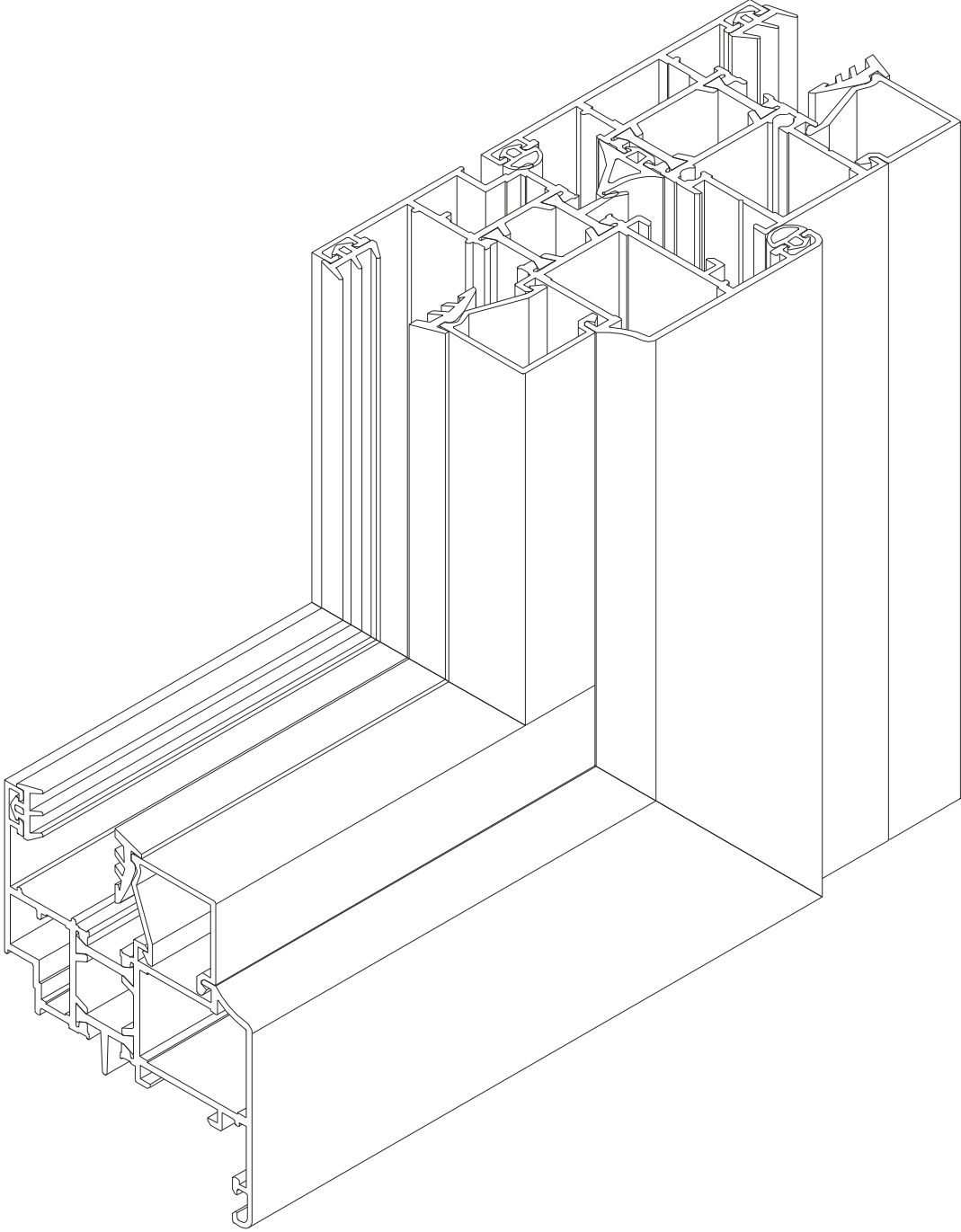
1

58

YALITIMLI SİSTEM DETAYLARI INSULATED SYSTEM DETAILS

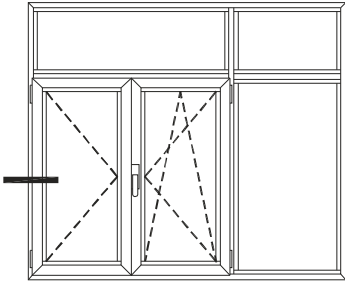

İÇE AÇILIR PENCERE
INWARD OPENING WINDOW

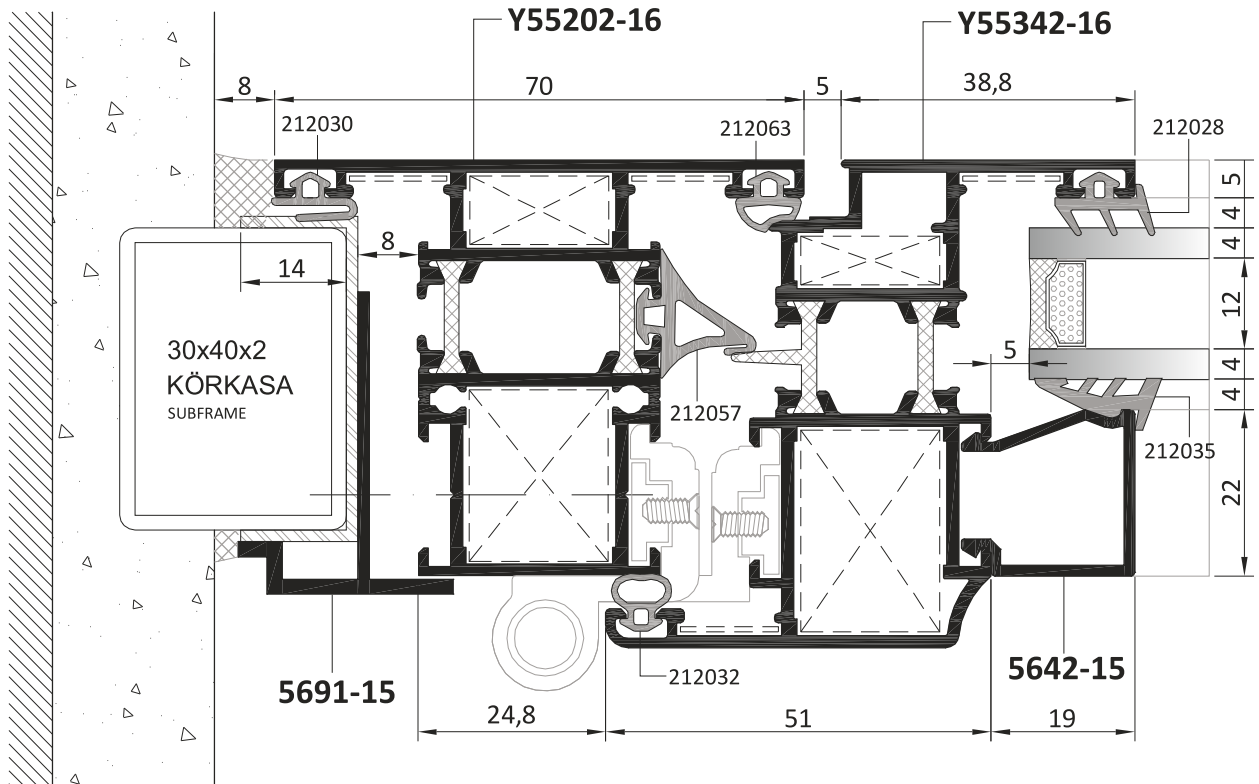
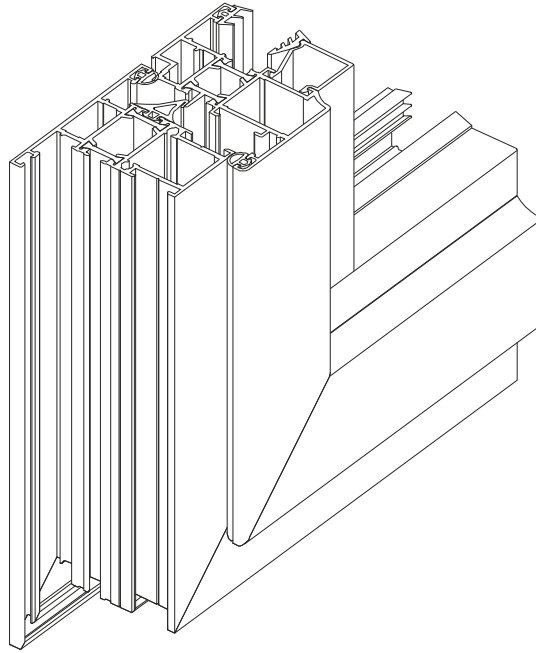

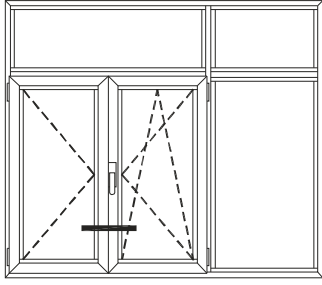

İÇE AÇILIR PENCERE
INWARD OPENING WINDOW

YALITIMLI SİSTEM DETAYLARI
INSULATED SYSTEM DETAILS

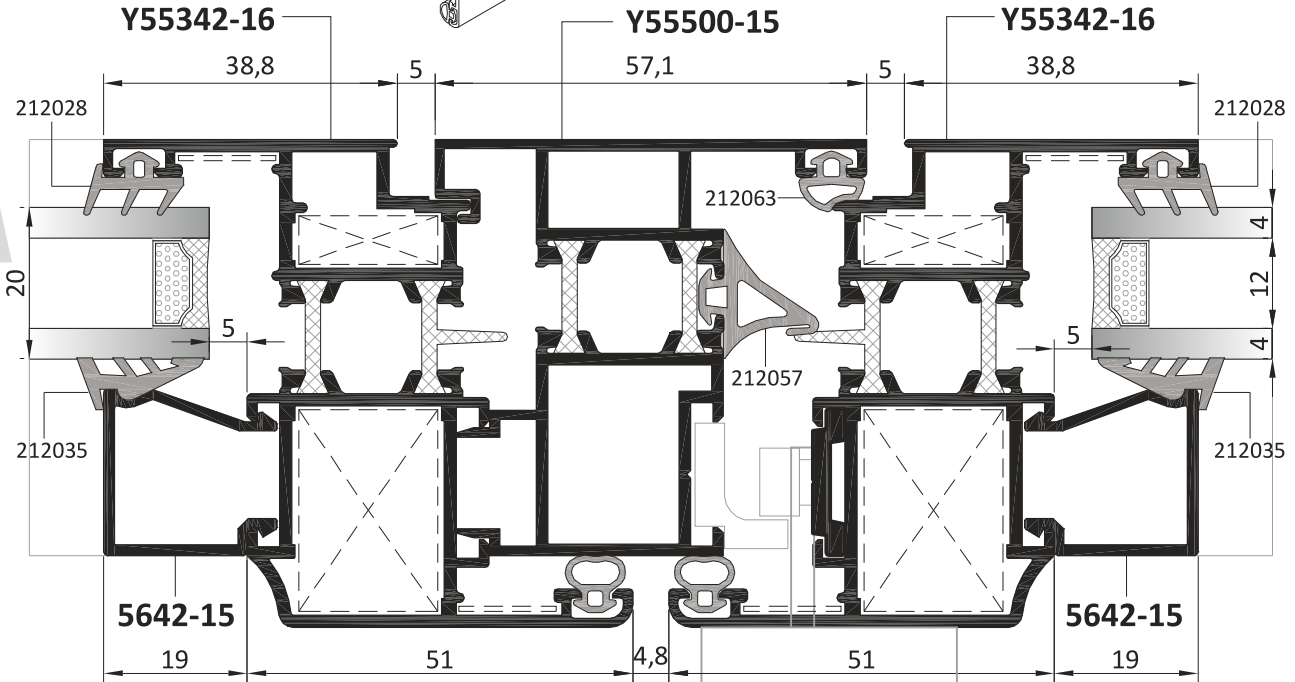
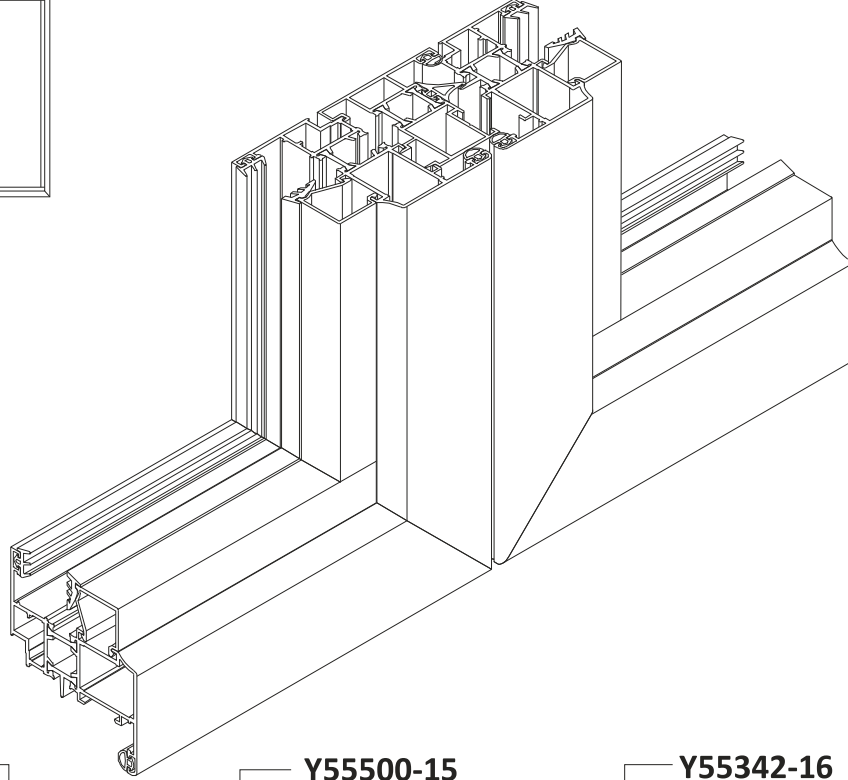

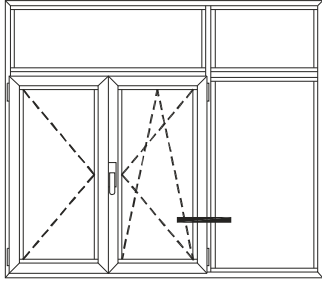

İÇE AÇILIR PENCERE
INWARD OPENING WINDOW

YALITIMLI SİSTEM DETAYLARI

INSULATED SYSTEM DETAILS

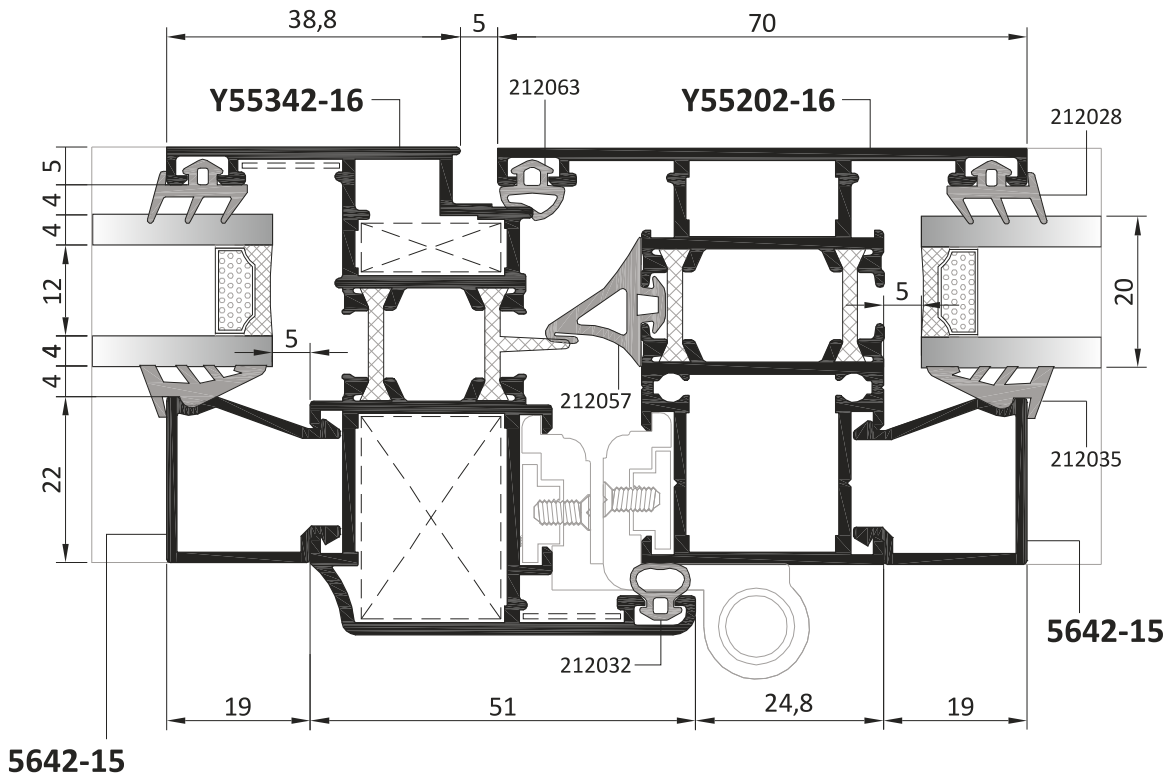
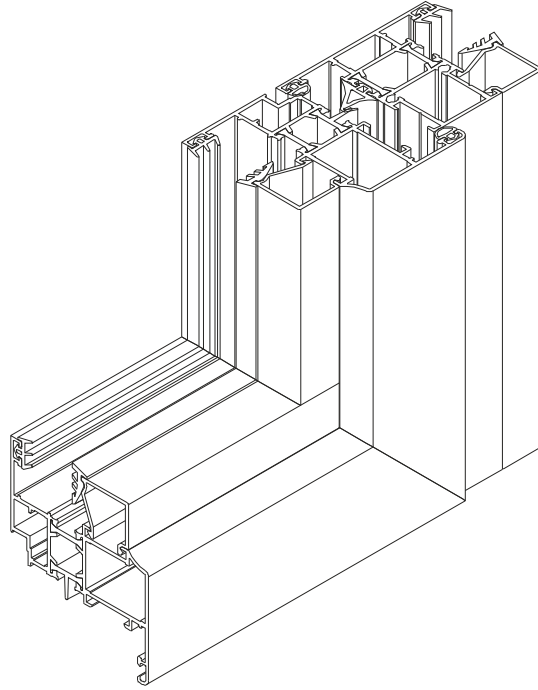

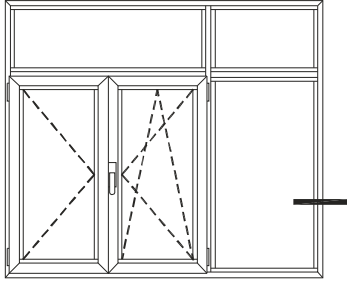

İÇE AÇILIR PENCERE
INWARD OPENING WINDOW

YALITIMLI SİSTEM DETAYLARI
INSULATED SYSTEM DETAILS

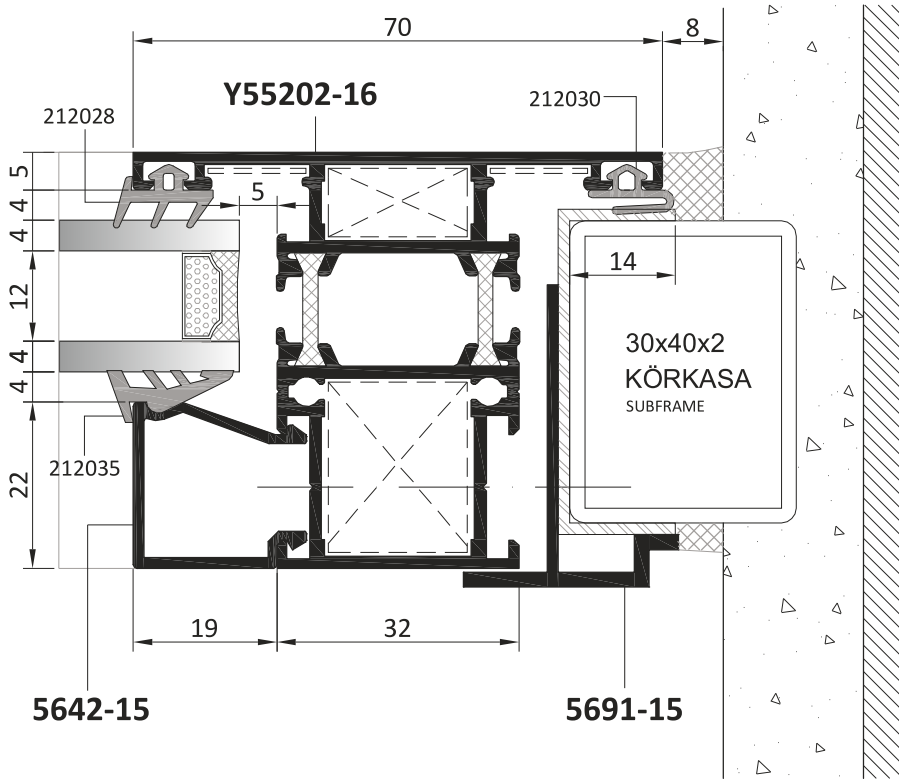
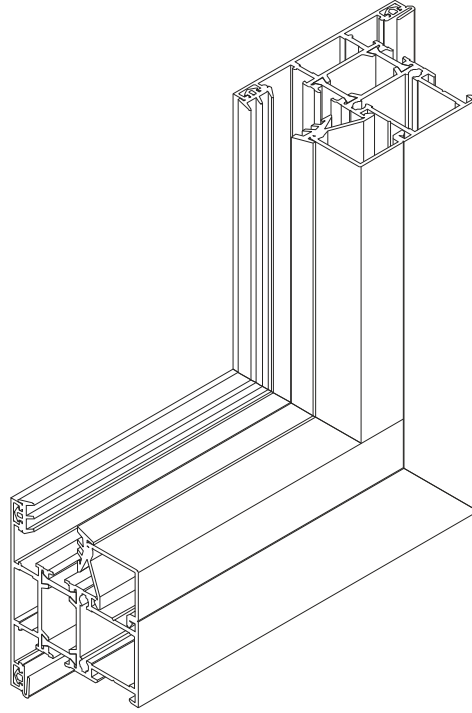

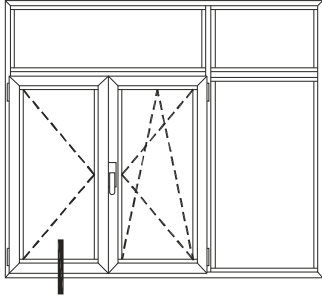

İÇE AÇILIR PENCERE
INWARD OPENING WINDOW

YALITIMLI SİSTEM DETAYLARI INSULATED SYSTEM DETAILS

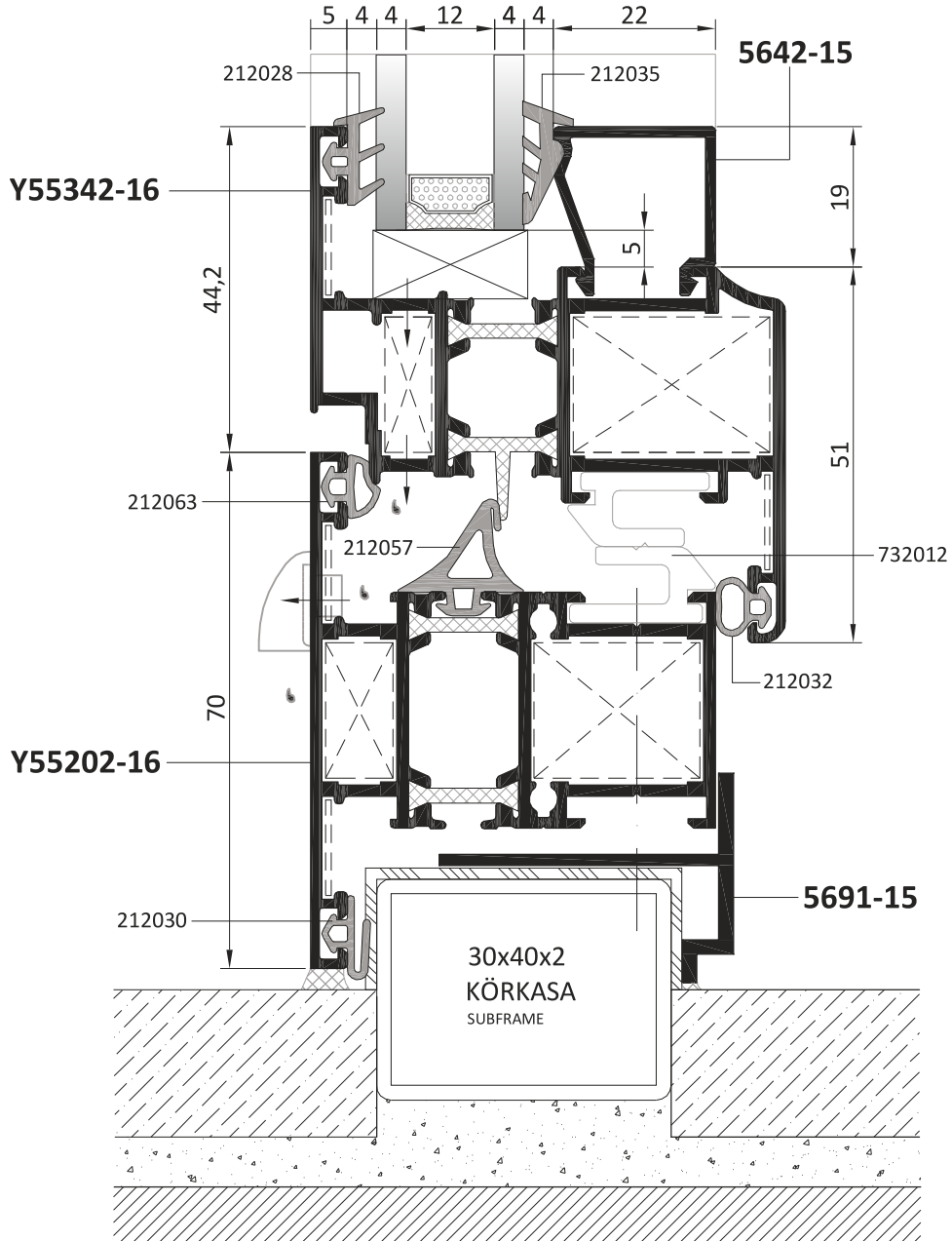

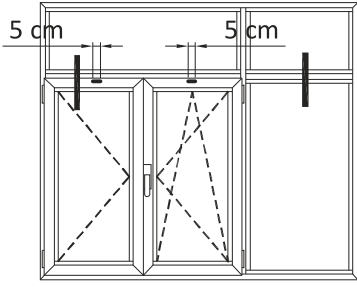

İÇE AÇILIR PENCERE
INWARD OPENING WINDOW

YALITIMLI SİSTEM DETAYLARI
INSULATED SYSTEM DETAILS

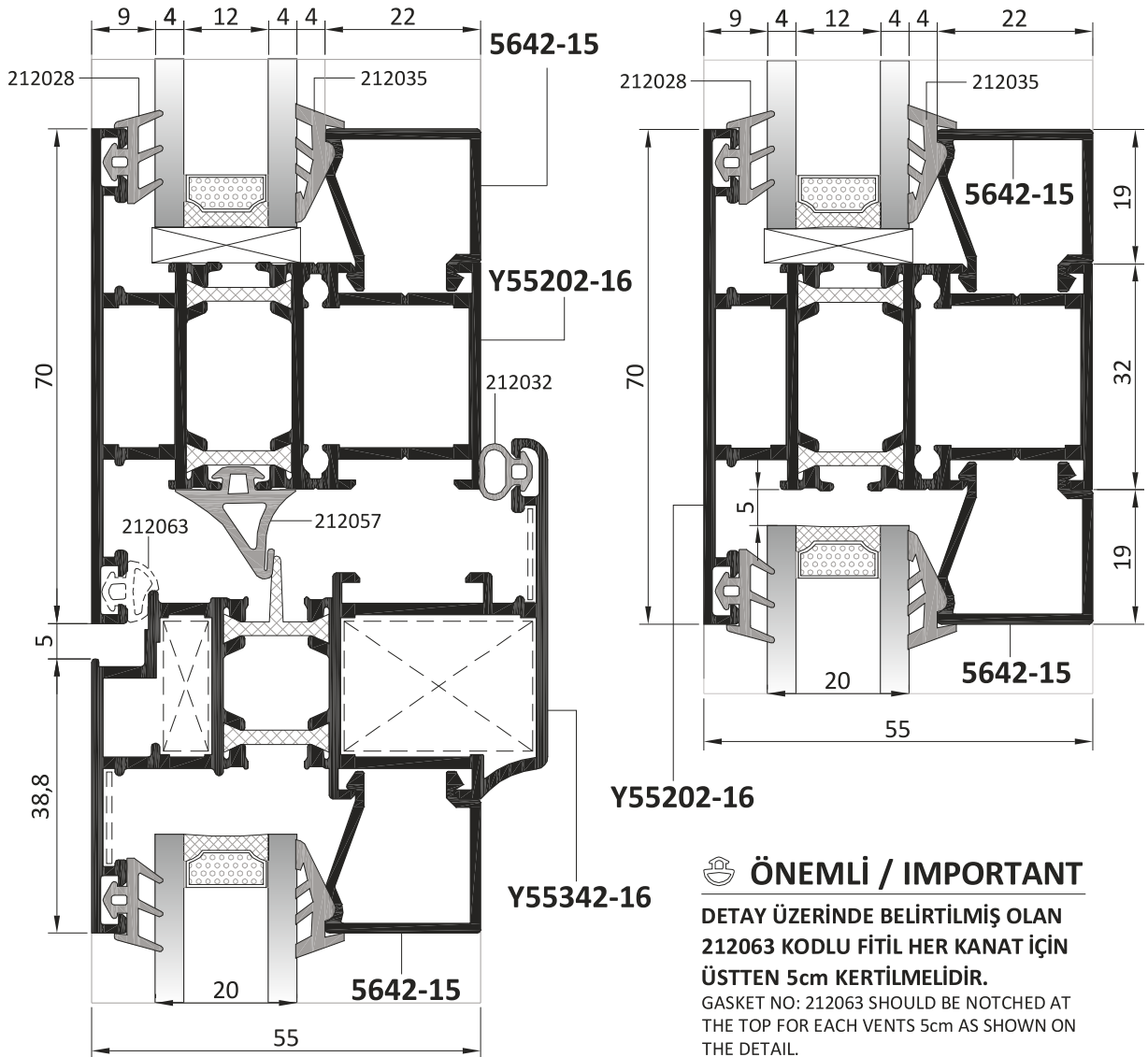

KÖŞE DÖNÜŞ DİLATASYON DETAYI

CORNER DILATATION DETAIL

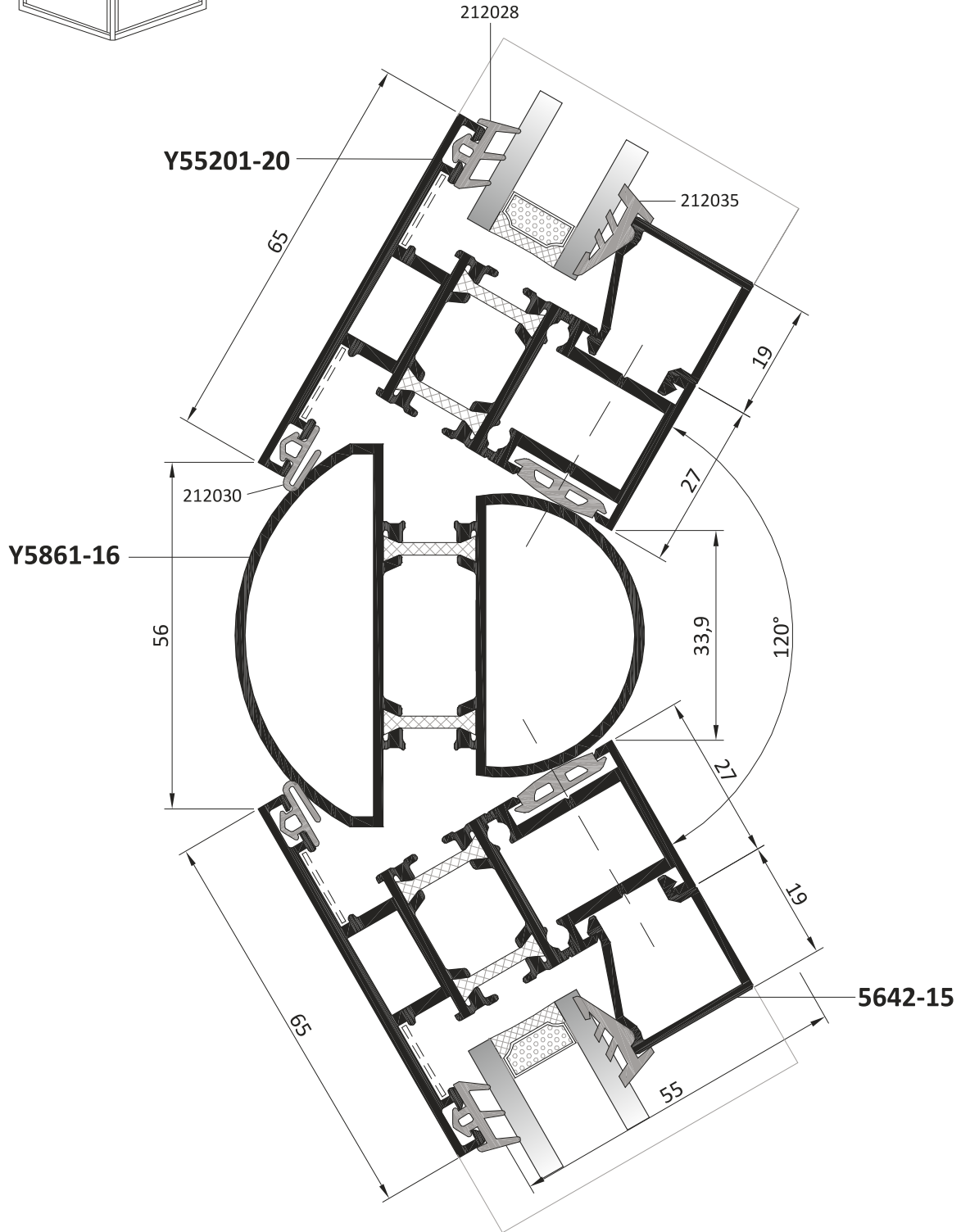
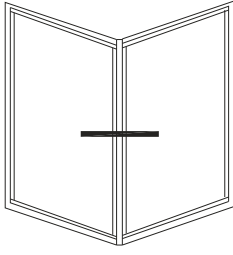

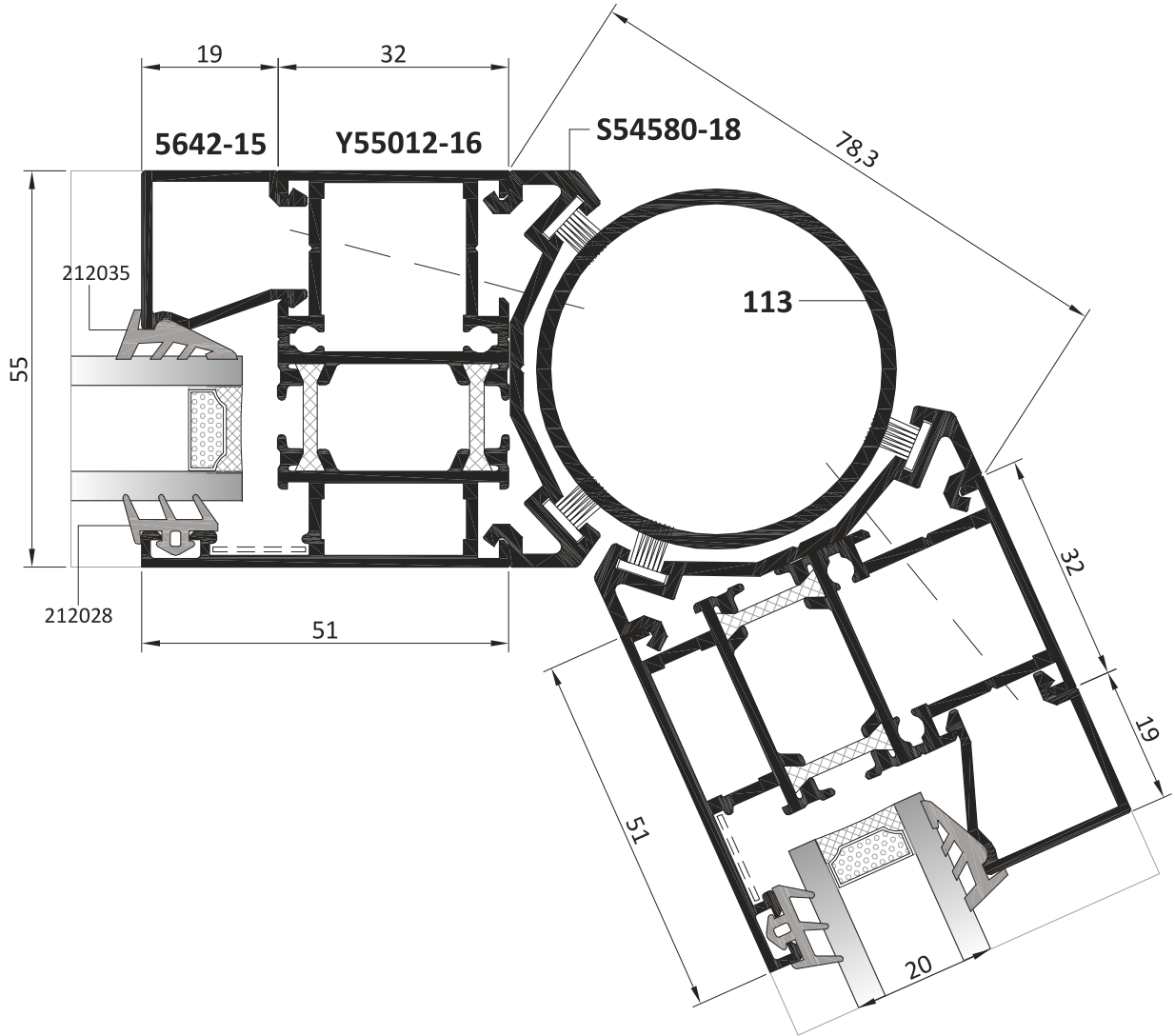
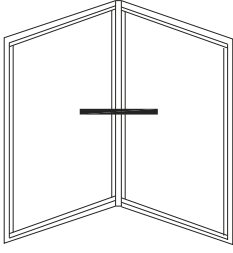
KÖŞE DÖNÜŞ DİLATASYON DETAYI
CORNER DILATATION DETAIL

KÖŞE DÖNÜŞ DİLATASYON DETAYI CORNER DILATATION DETAIL

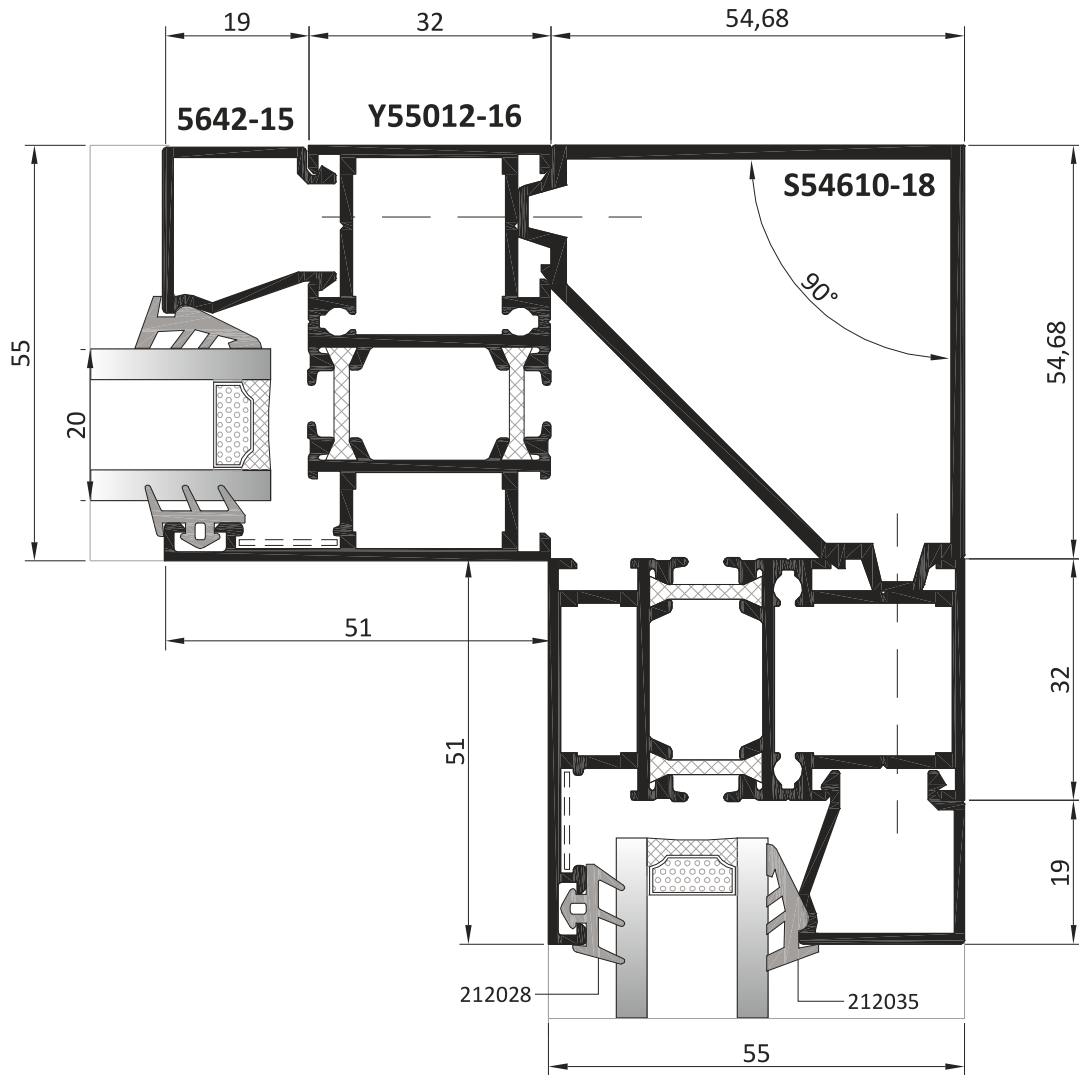
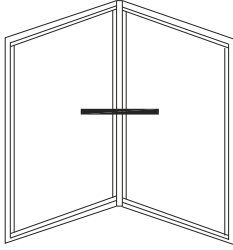

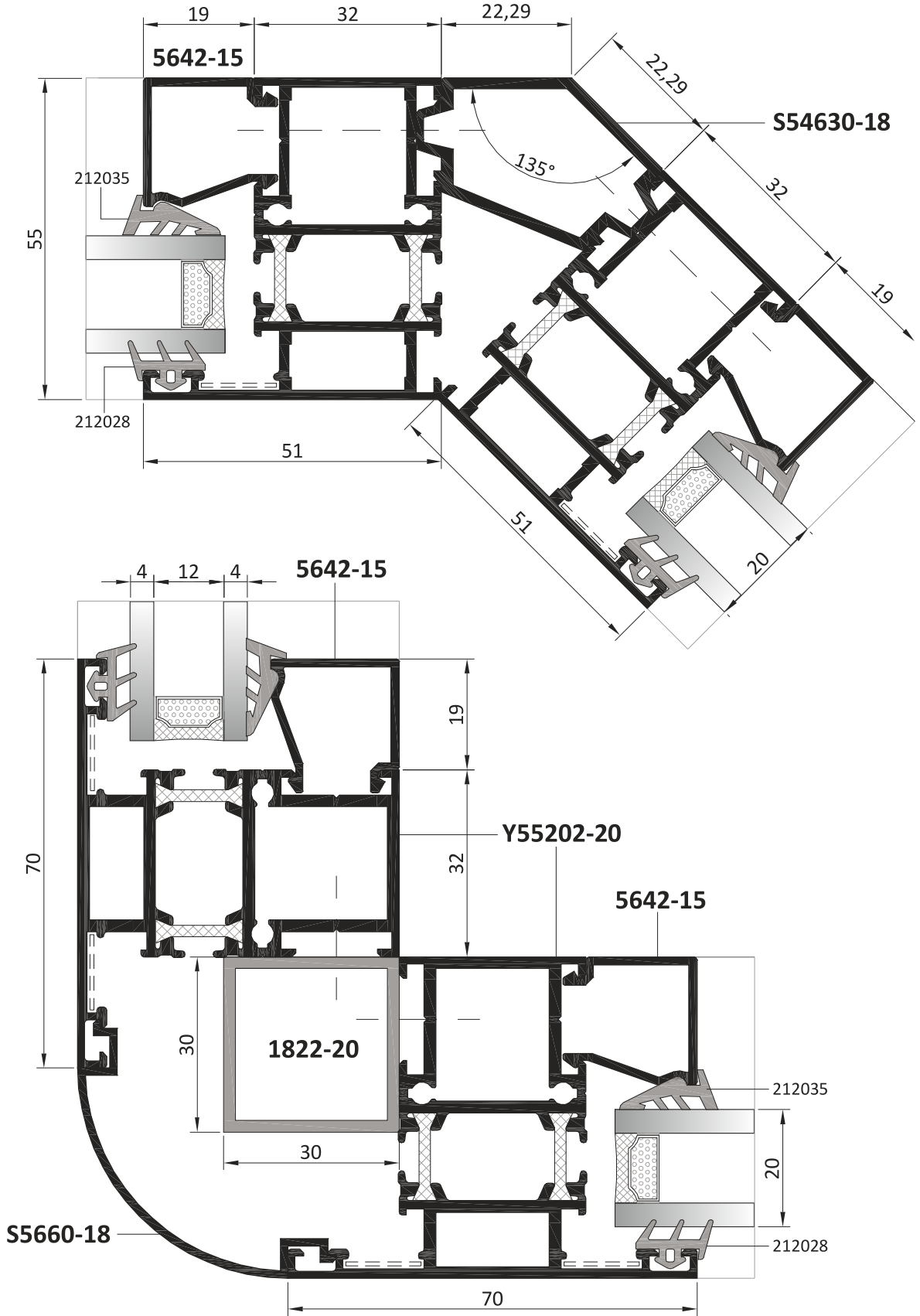
KÖŞE DÖNÜŞ DİLATASYON DETAYI
CORNER DILATATION DETAIL

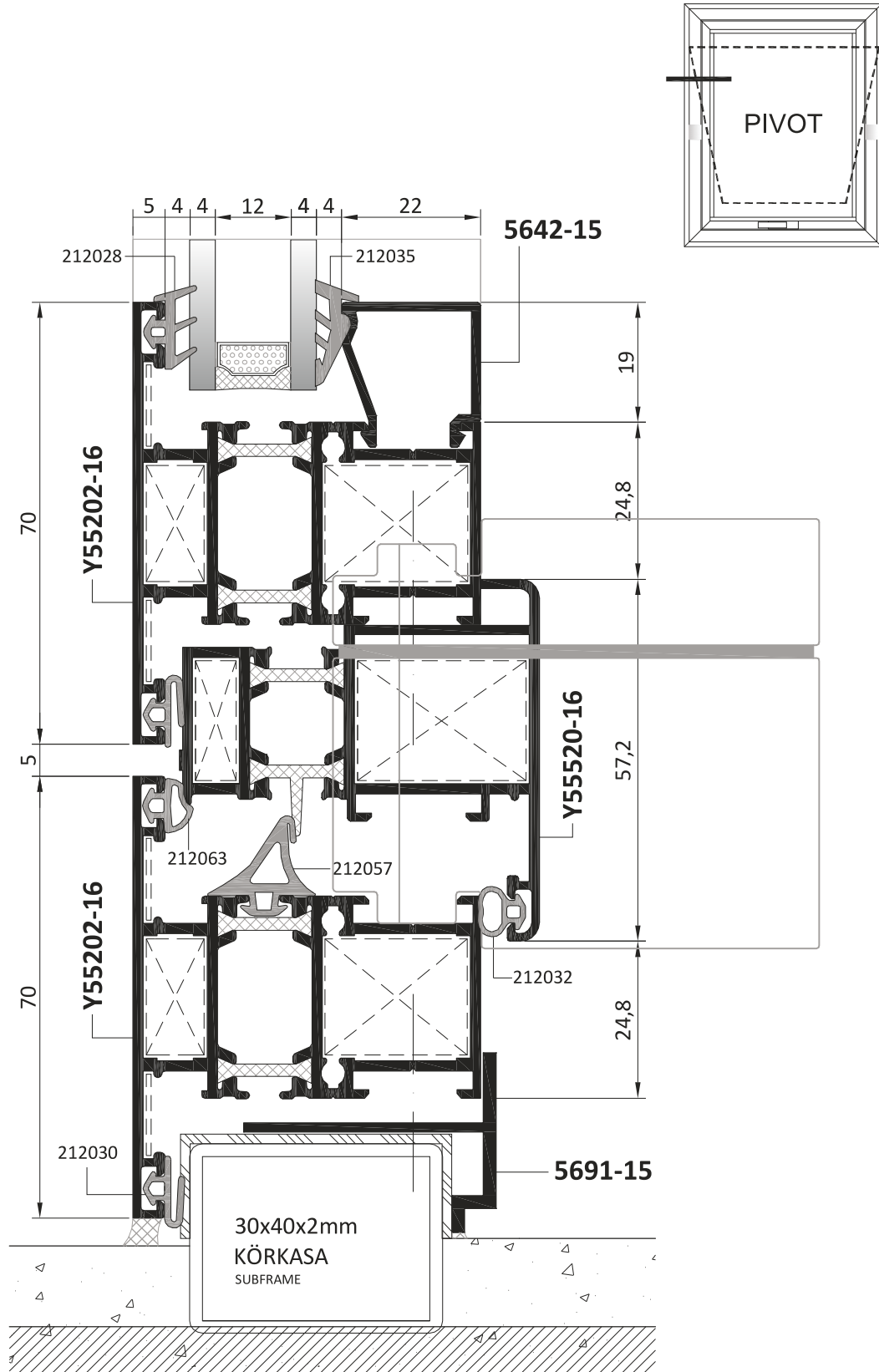

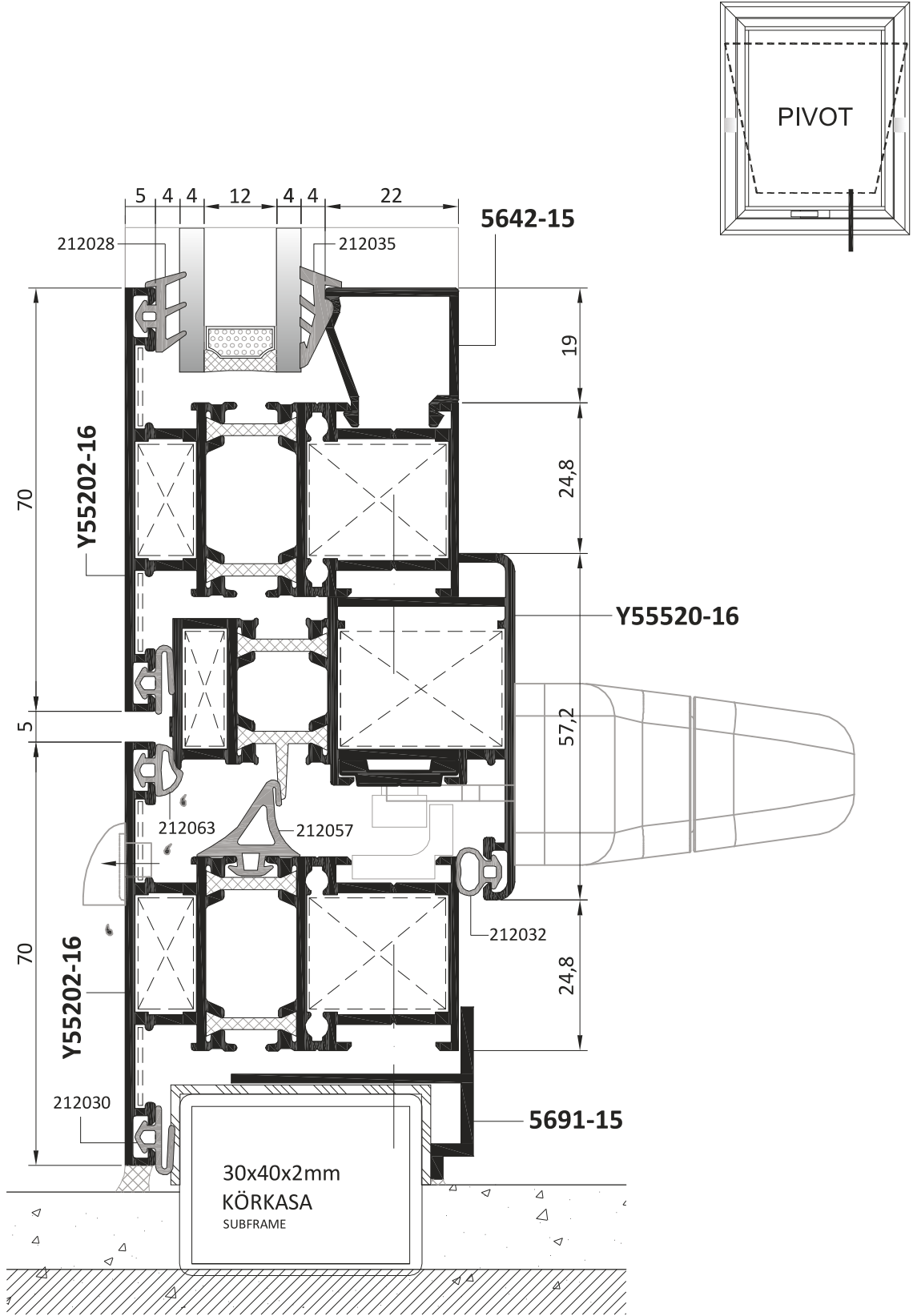

70

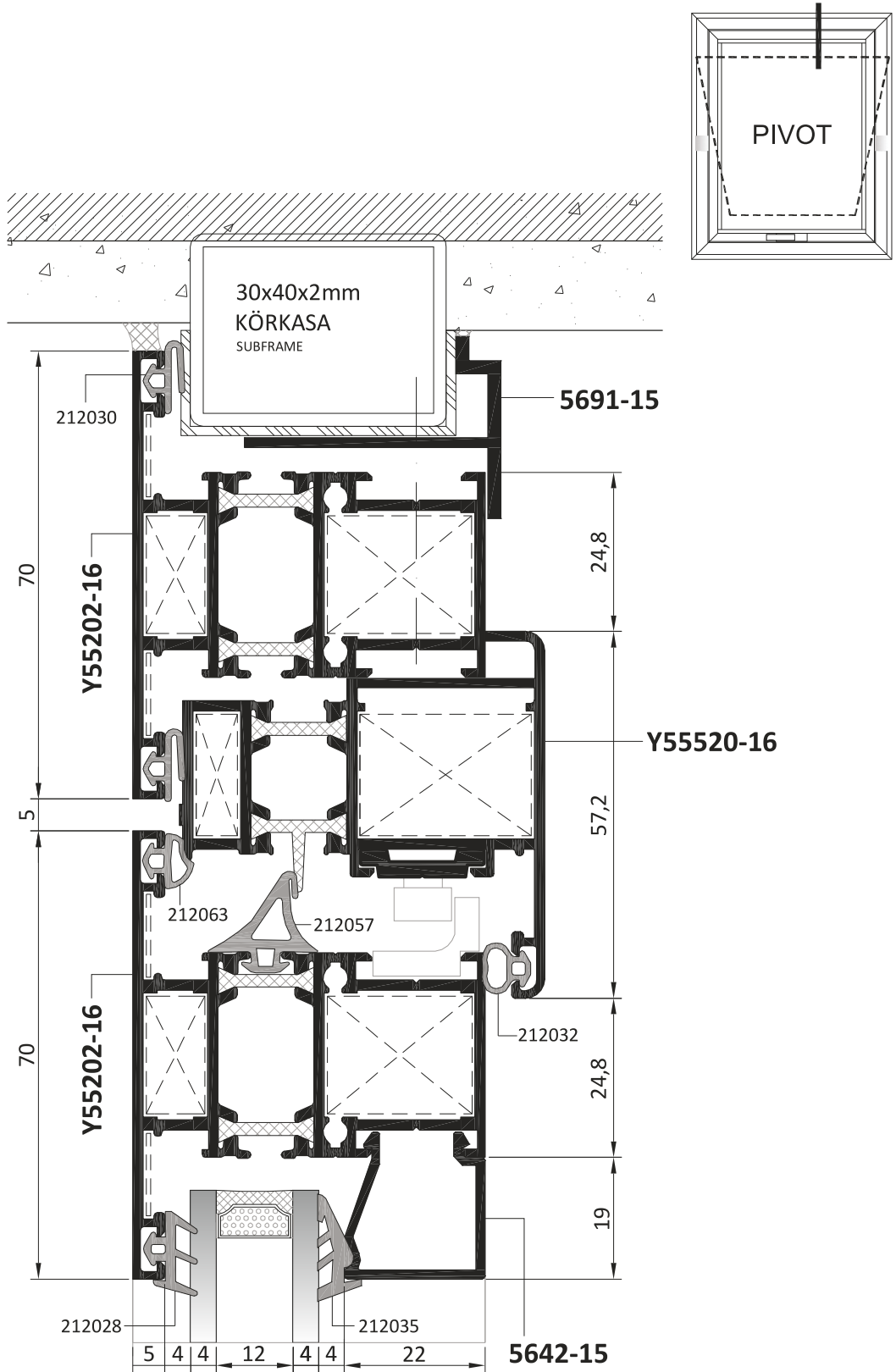

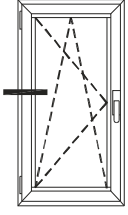
YALITIMLI SİSTEM DETAYLARI
INSULATED SYSTEM DETAILS

İÇE AÇILIR PENCERE
INWARD OPENING WINDOW

**** PVC ÇİFT AÇILIM AKSESUARINA UYGUN PENCERE DETAYI**
PVC TILT&TURN ACCESSORY APPROPRIATED WINDOW DETAIL

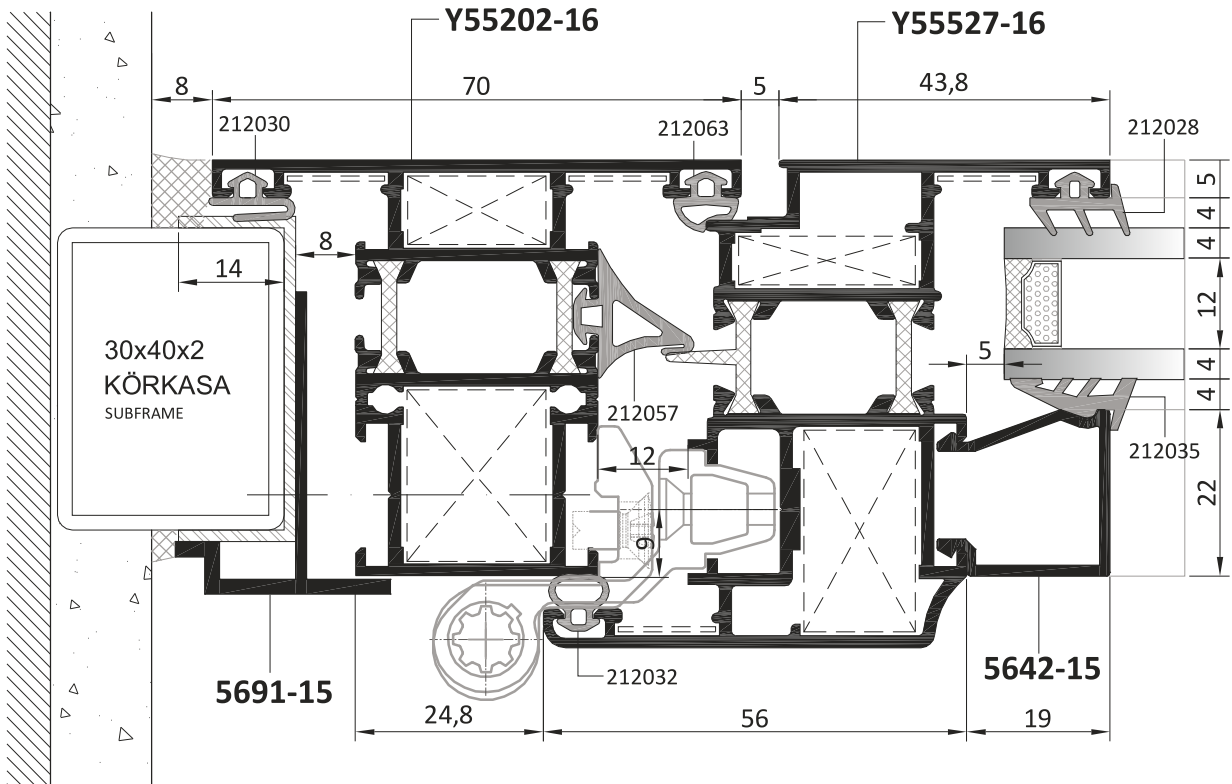

YALITIMLI SİSTEM DETAYLARI INSULATED SYSTEM DETAILS

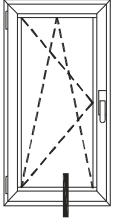

İÇE AÇILIR PENCERE
INWARD OPENING WINDOW

** PVC ÇİFT AÇILIM AKSESUARINA UYGUN PENCERE DETAYI PVC TILT&TURN ACCESSORY APPROPRIATED WINDOW DETAIL

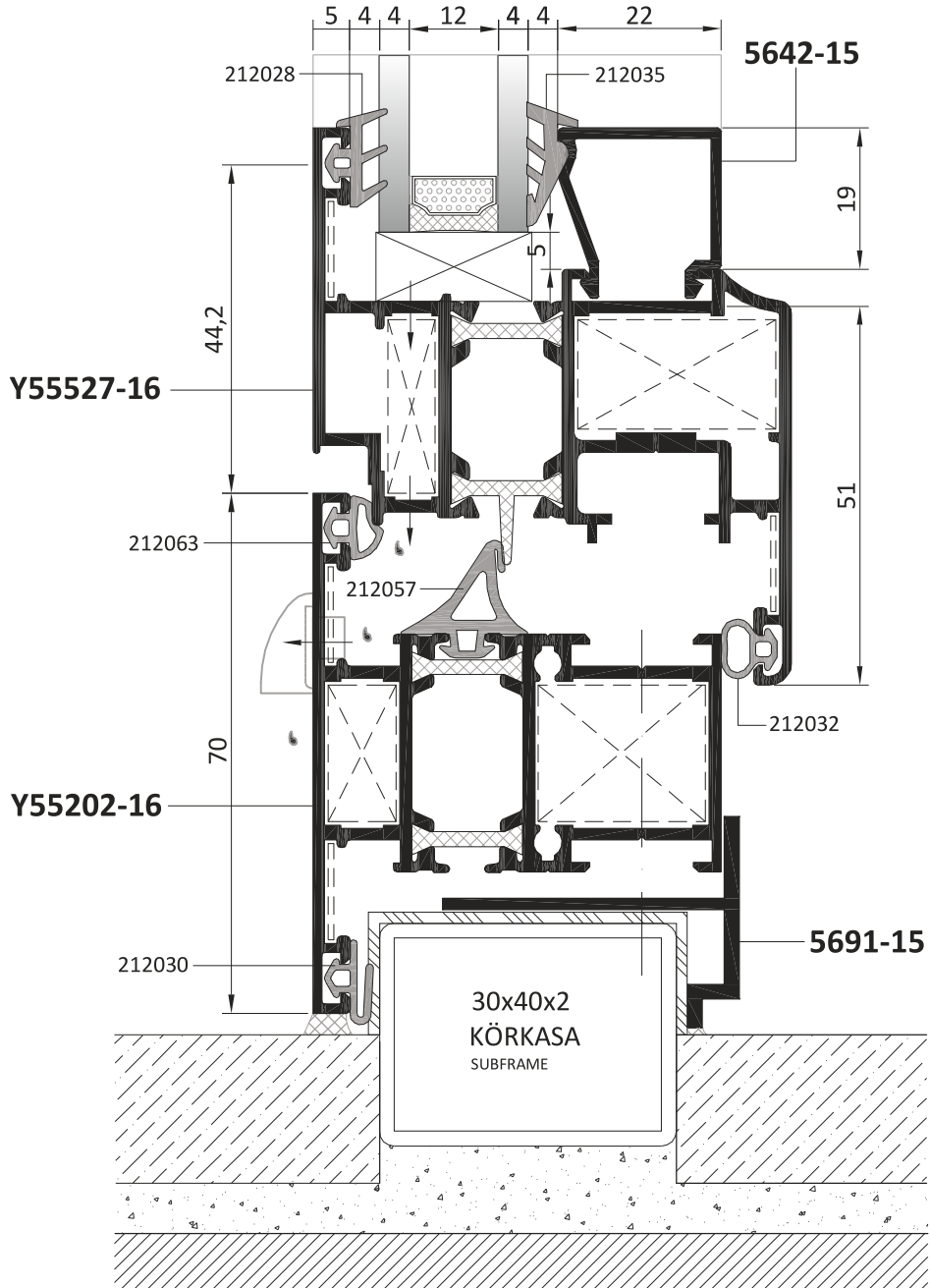

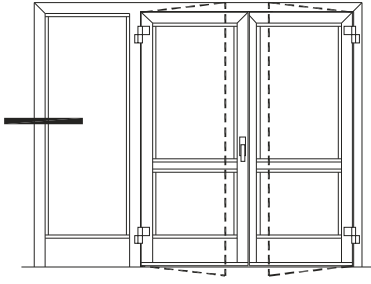
**İÇE AÇILIR BİNİLİ KAPI**

INWARD OPENING DOOR WITH STEP HINGE

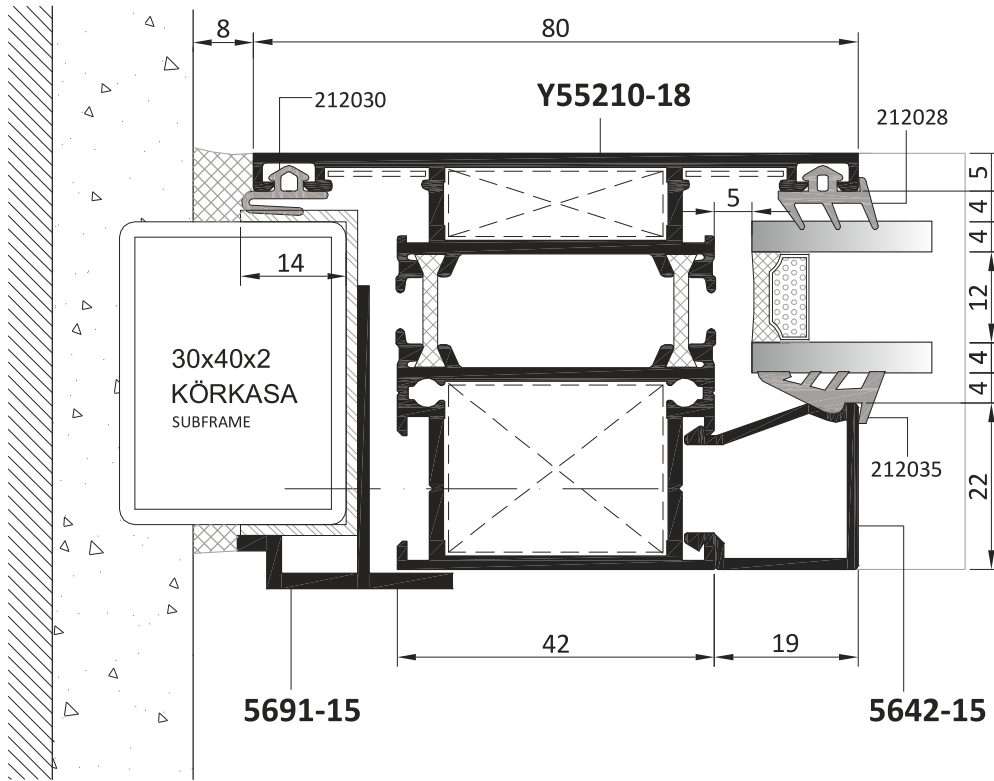
YALITIMLI SİSTEM DETAYLARI
INSULATED SYSTEM DETAILS

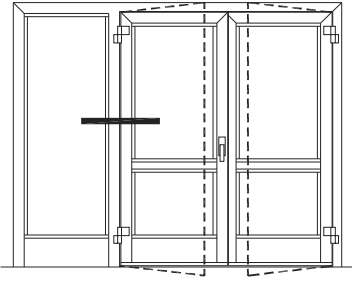

İÇE AÇILIR BİNLİ KAPI

INWARD OPENING DOOR WITH STEP HINGE

YALITIMLI SİSTEM DETAYLARI INSULATED SYSTEM DETAILS

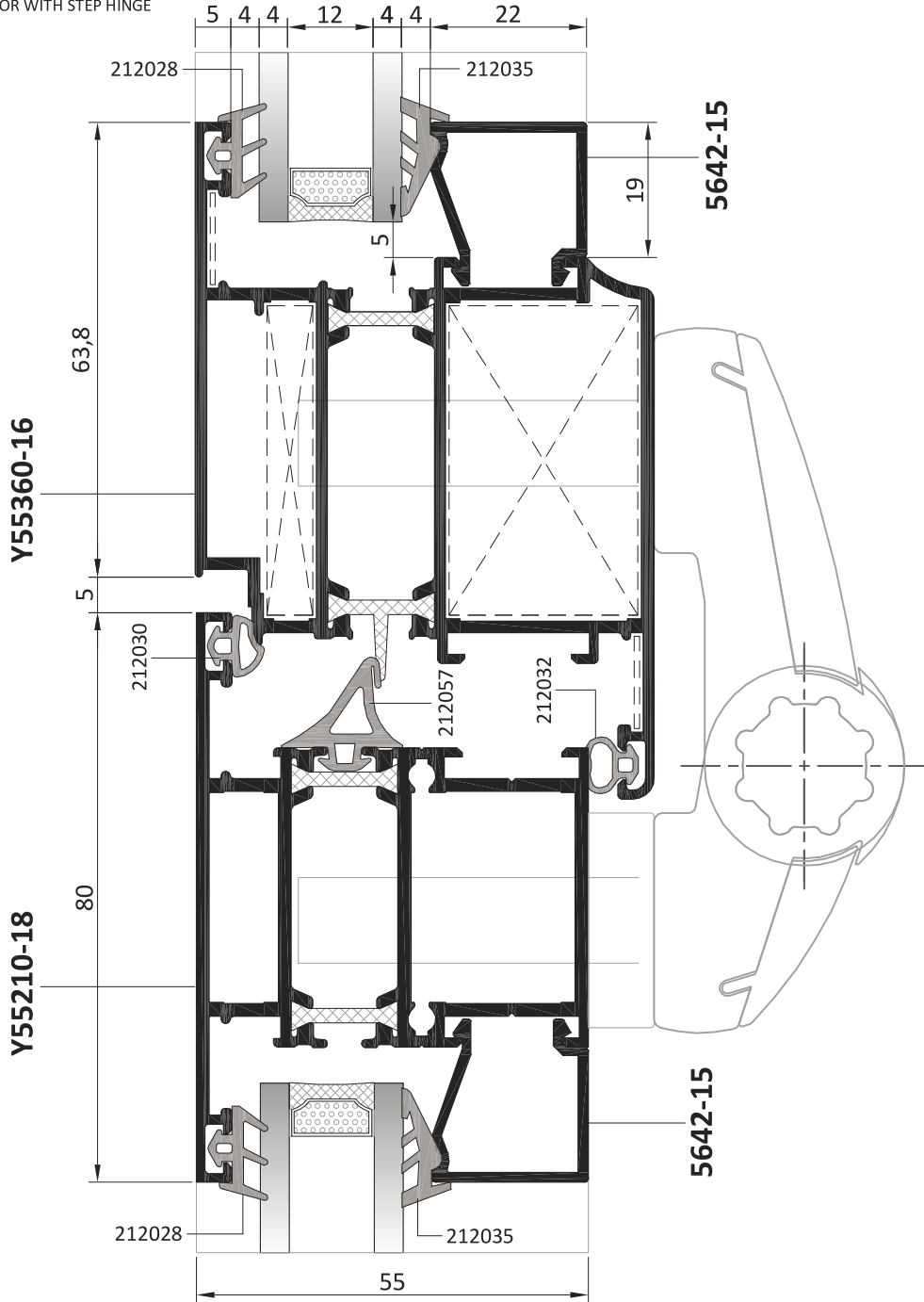

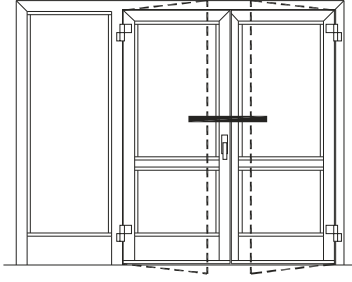

İÇE AÇILIR BİNİLİ KAPI
INWARD OPENING DOOR WITH STEP HINGE

YALITIMLI SİSTEM DETAYLARI
INSULATED SYSTEM DETAILS

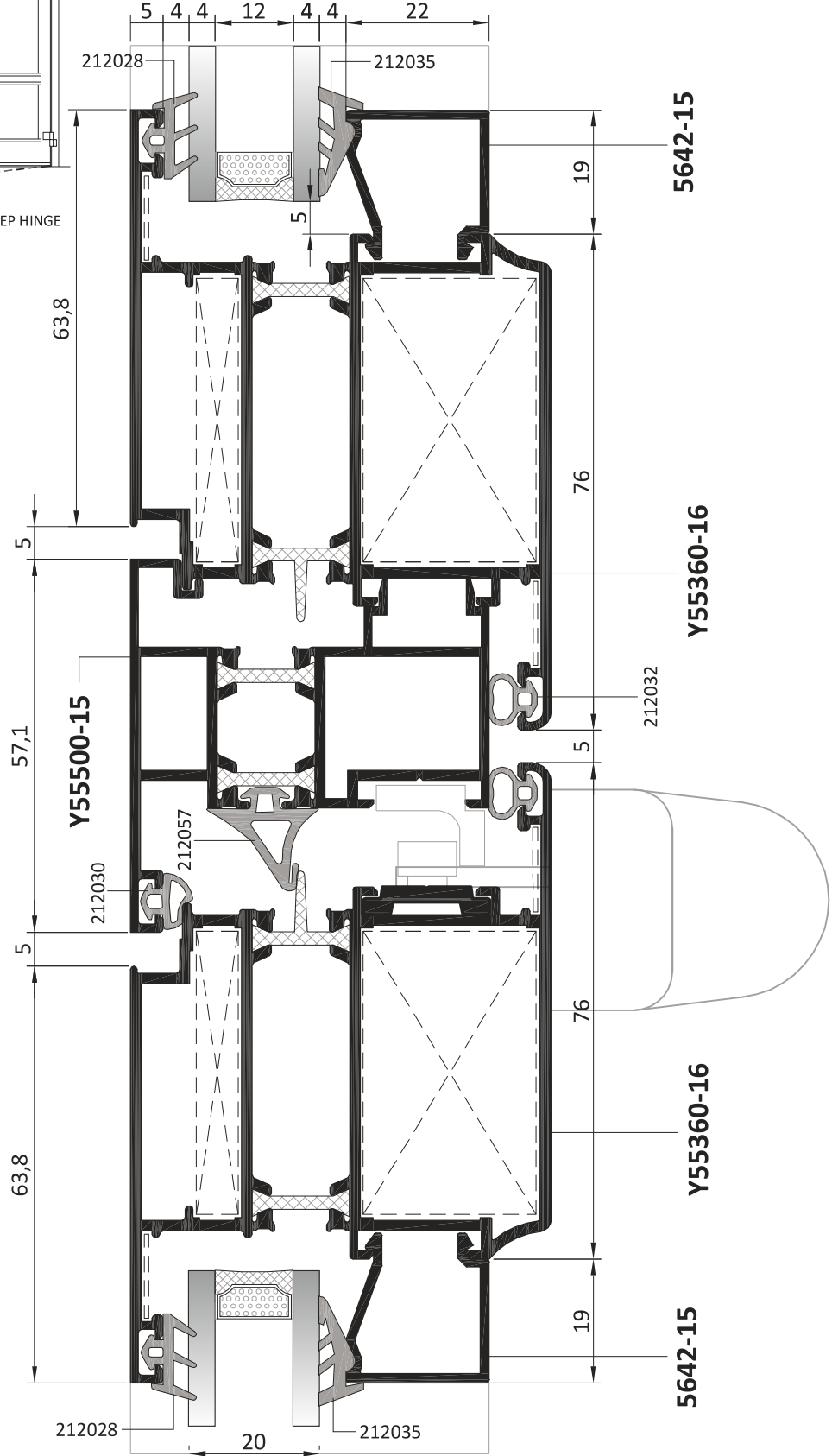

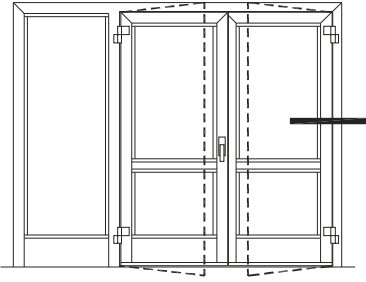

İÇE AÇILIR BİNİLİ KAPI
INWARD OPENING DOOR WITH STEP HINGE

YALITIMLI SİSTEM DETAYLARI

INSULATED SYSTEM DETAILS

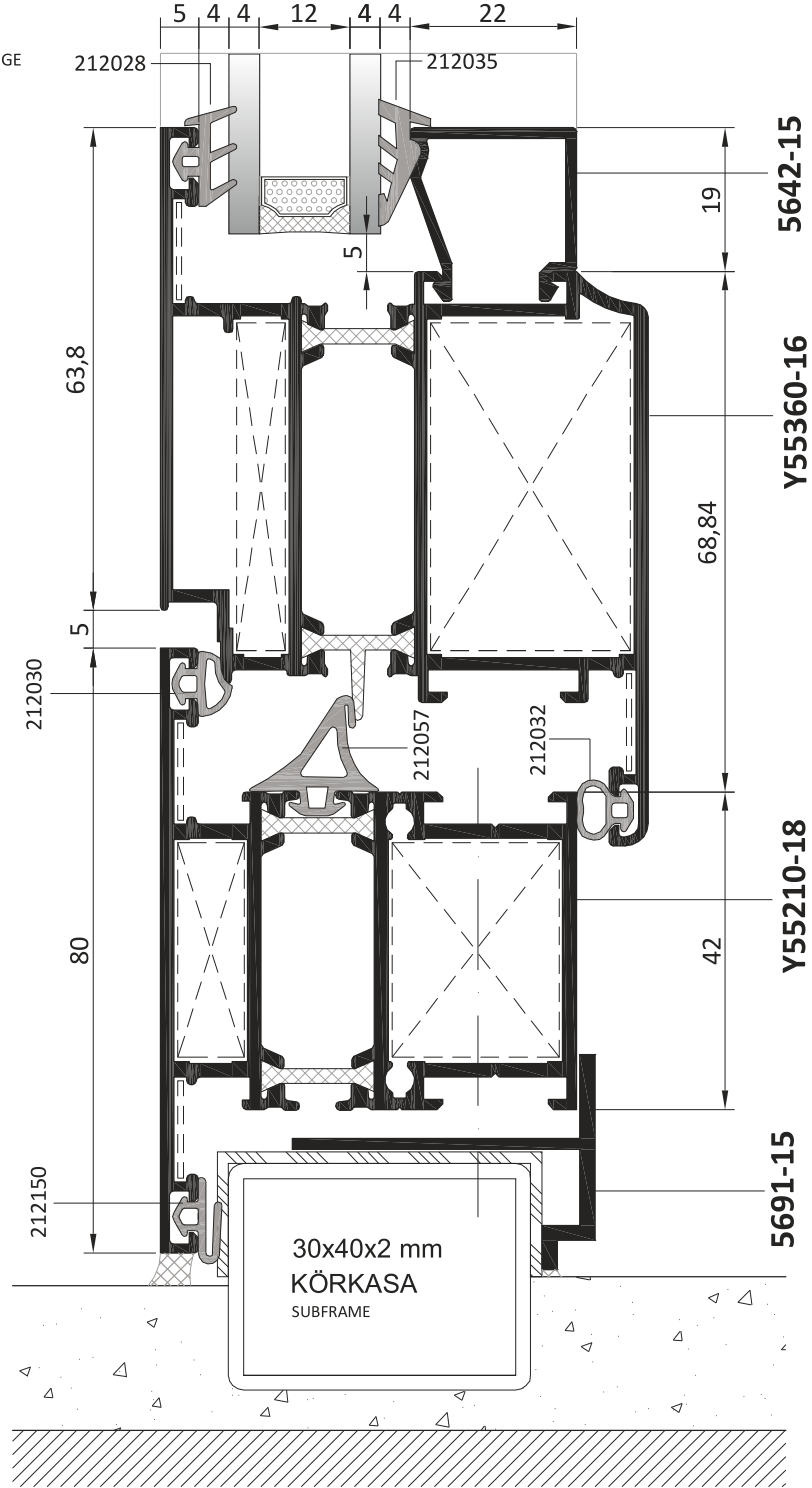

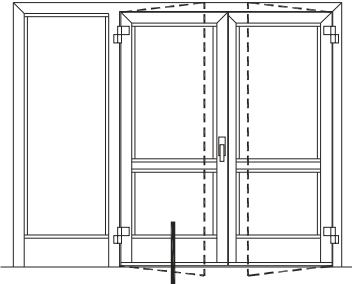

İÇE AÇILIR BİNİLİ KAPI
INWARD OPENING DOOR WITH STEP HINGE

YALITIMLI SİSTEM DETAYLARI INSULATED SYSTEM DETAILS

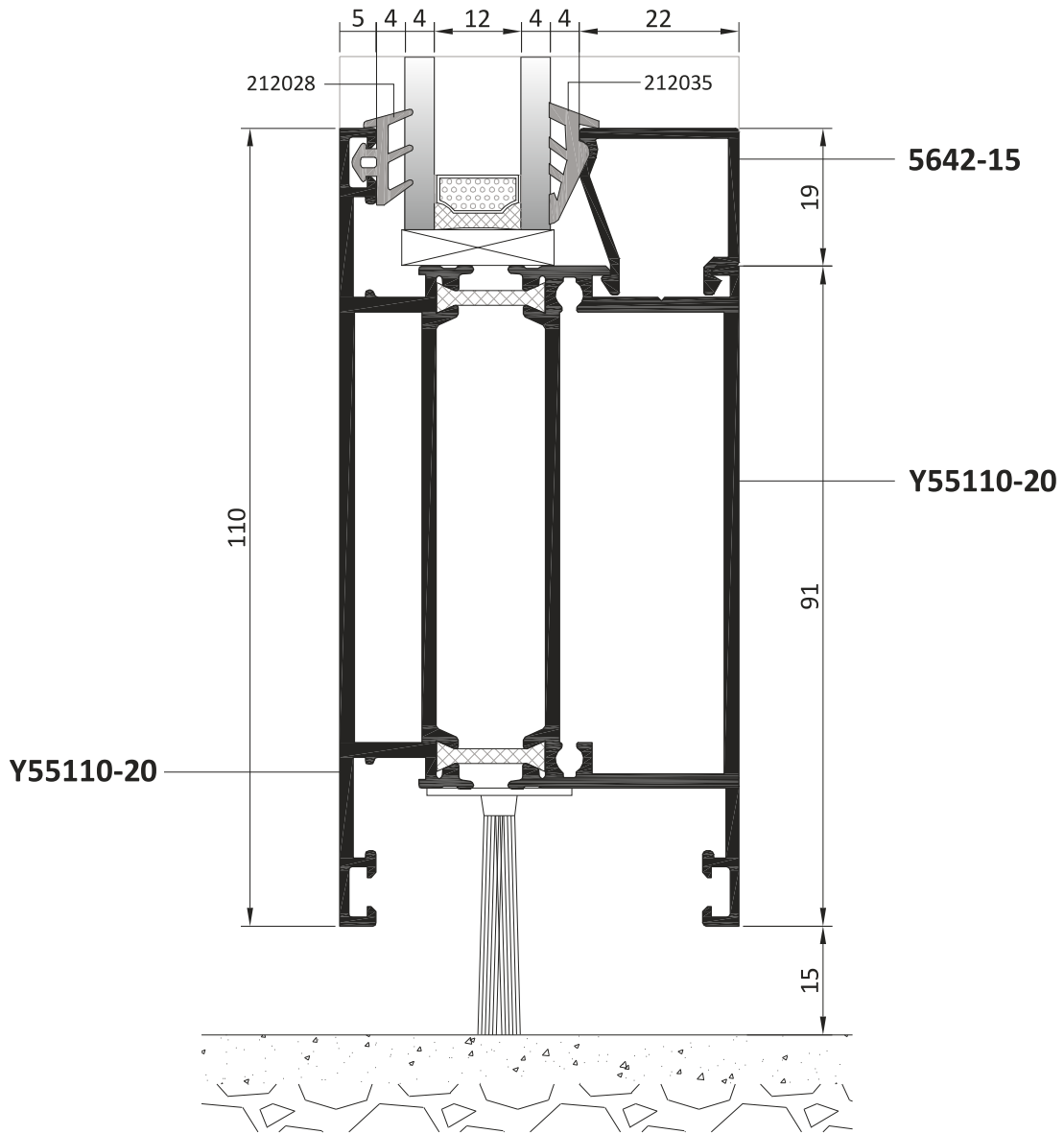

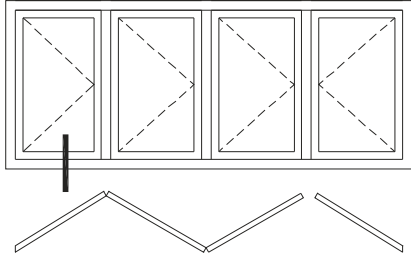

KATLANIR KAPI
FOLDING DOOR

YALITIMLI SİSTEM DETAYLARI
INSULATED SYSTEM DETAILS

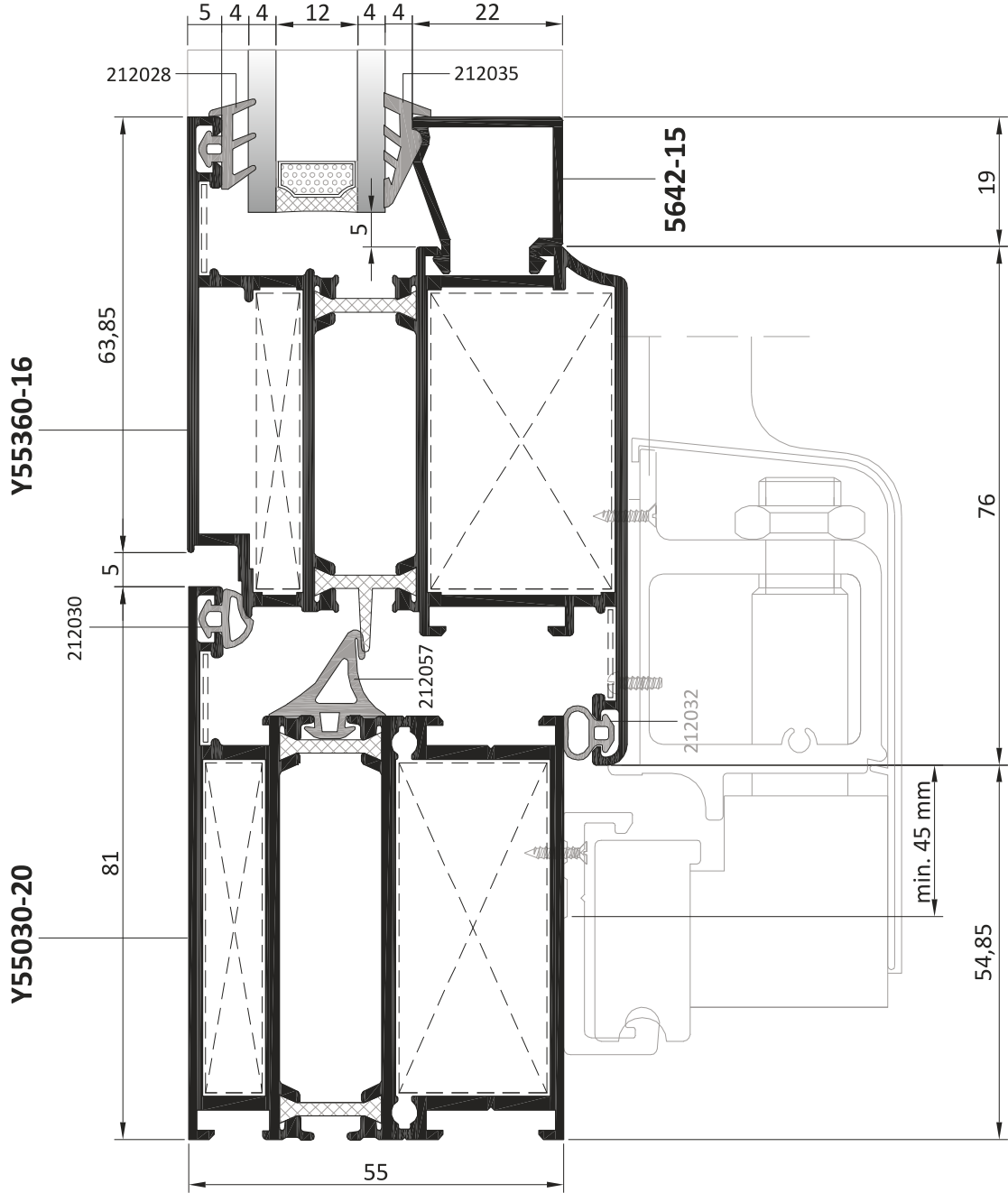

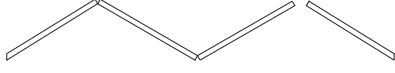
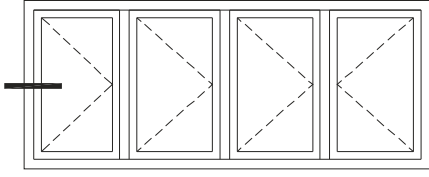

KATLANIR KAPI
FOLDING DOOR

YALITIMLI SİSTEM DETAYLARI INSULATED SYSTEM DETAILS

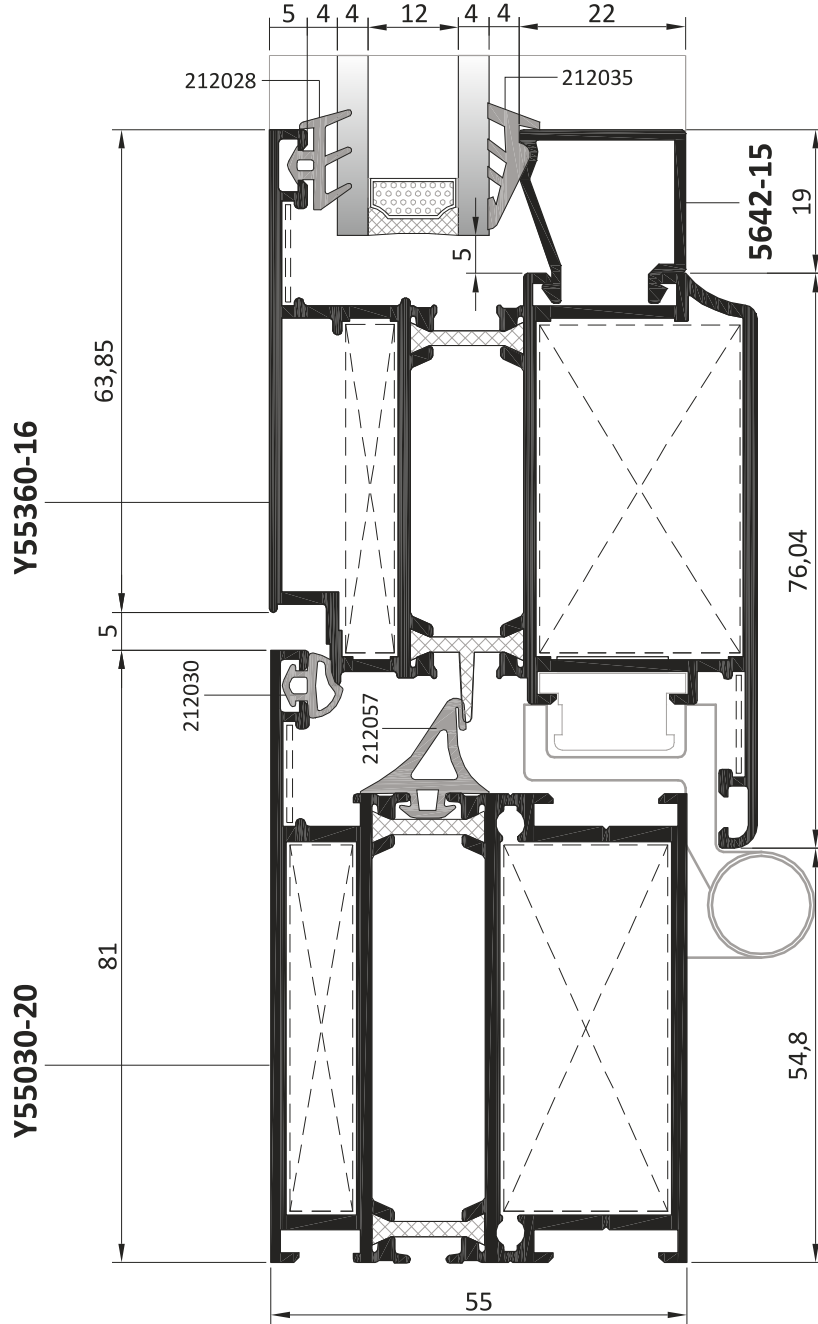

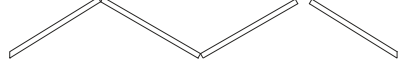
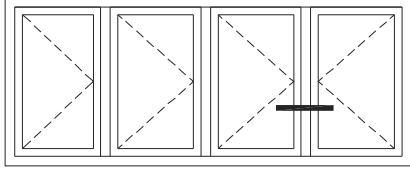
YALITIMLI SİSTEM DETAYLARI
INSULATED SYSTEM DETAILS**KATLANIR KAPI**
FOLDING DOOR**Y55360-16****Y55500-15****Y55360-16**

212030

212057

212032

212032

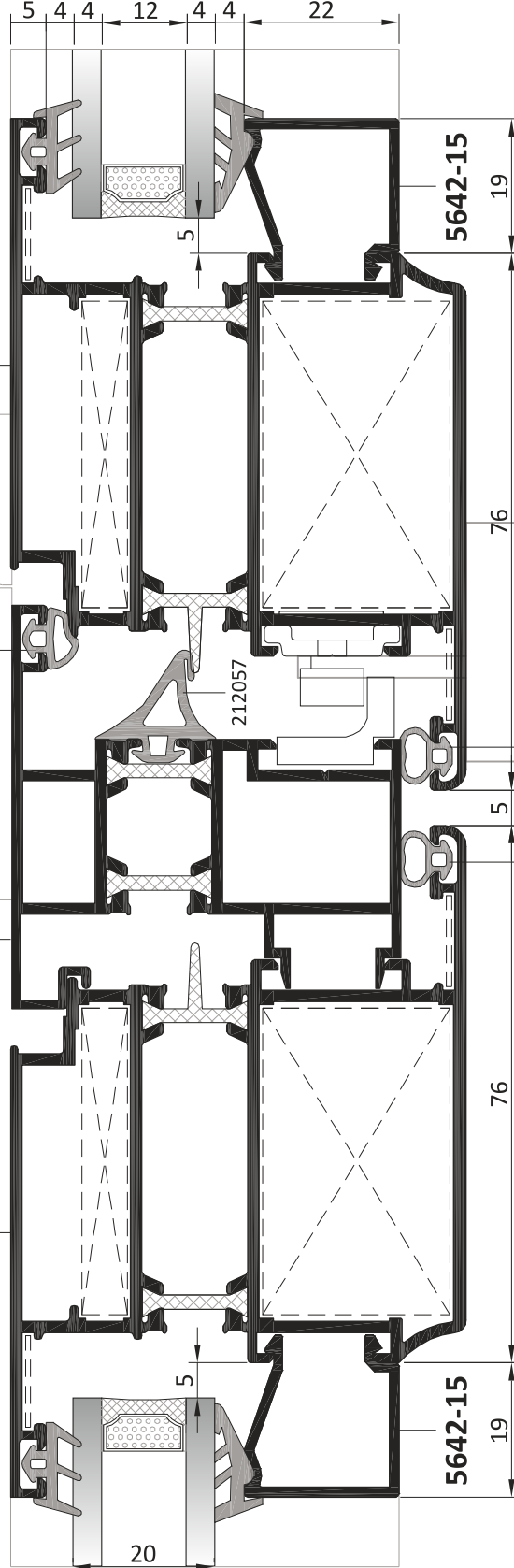

YALITIMLI SİSTEM DETAYLARI INSULATED SYSTEM DETAILS

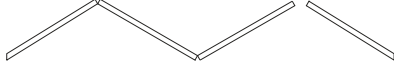
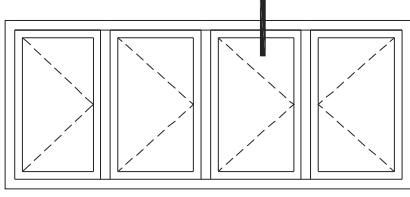

KATLANIR KAPI
FOLDING DOOR

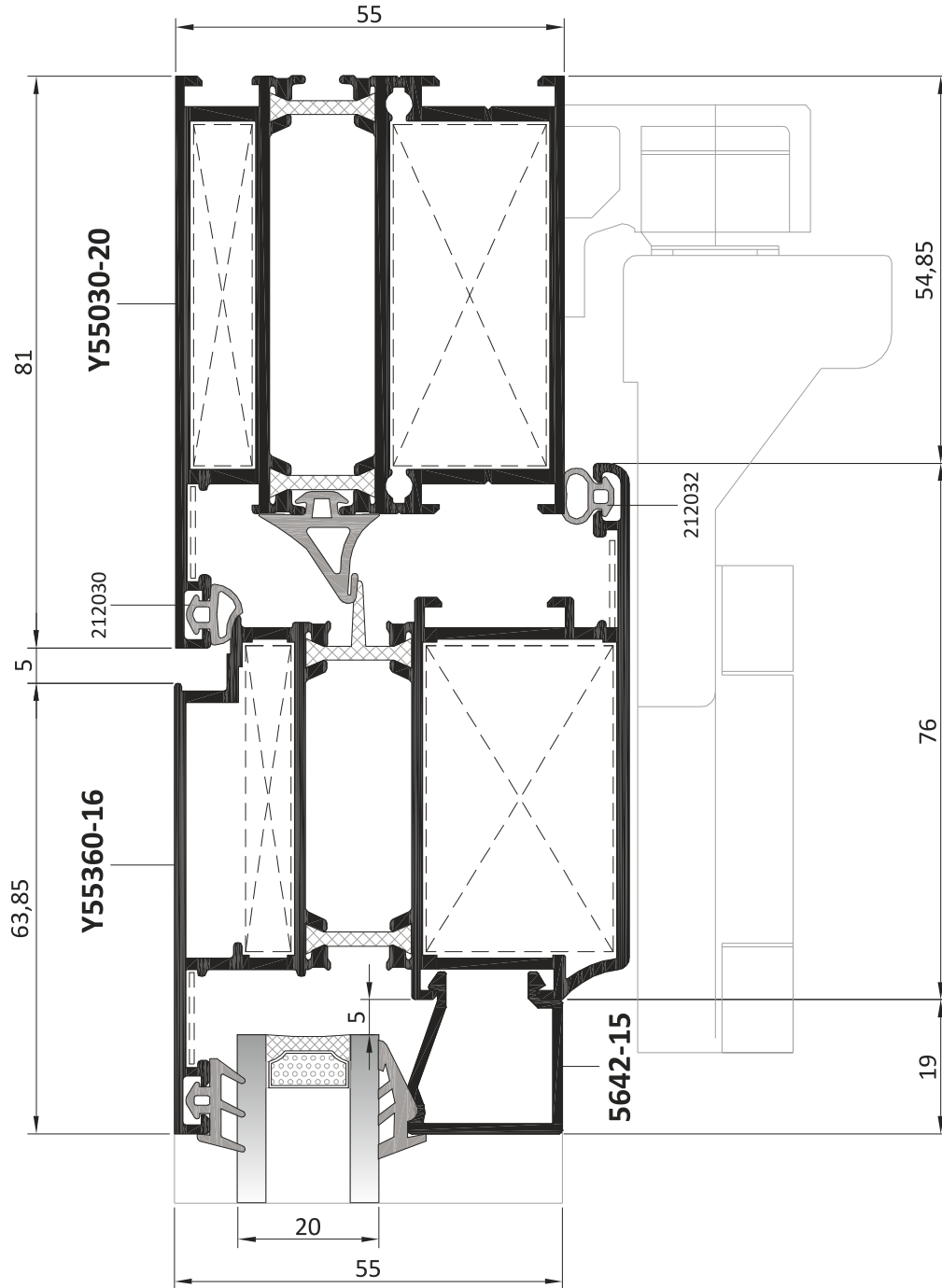

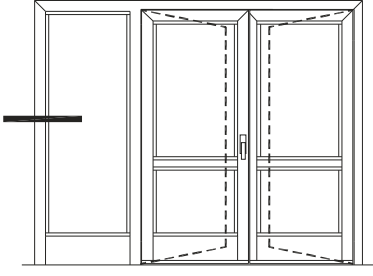
**DIŐA AÇILIR BİNİLİ KAPI**

OUTWARD OPENING DOOR WITH STEP HINGE

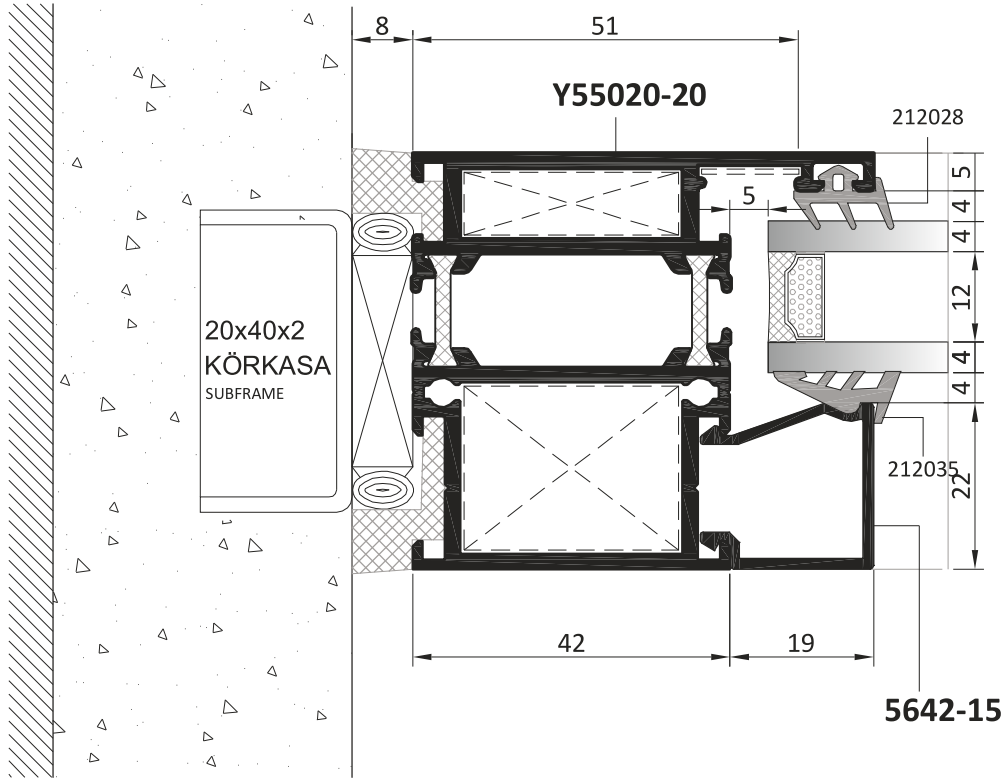
YALITIMLI SİSTEM DETAYLARI
INSULATED SYSTEM DETAILS

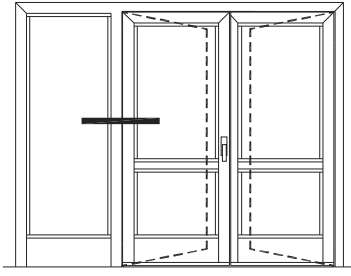

DIŐA AÇILIR BİNİLİ KAPI
OUTWARD OPENING DOOR WITH STEP HINGE

YALITIMLI SİSTEM DETAYLARI

INSULATED SYSTEM DETAILS

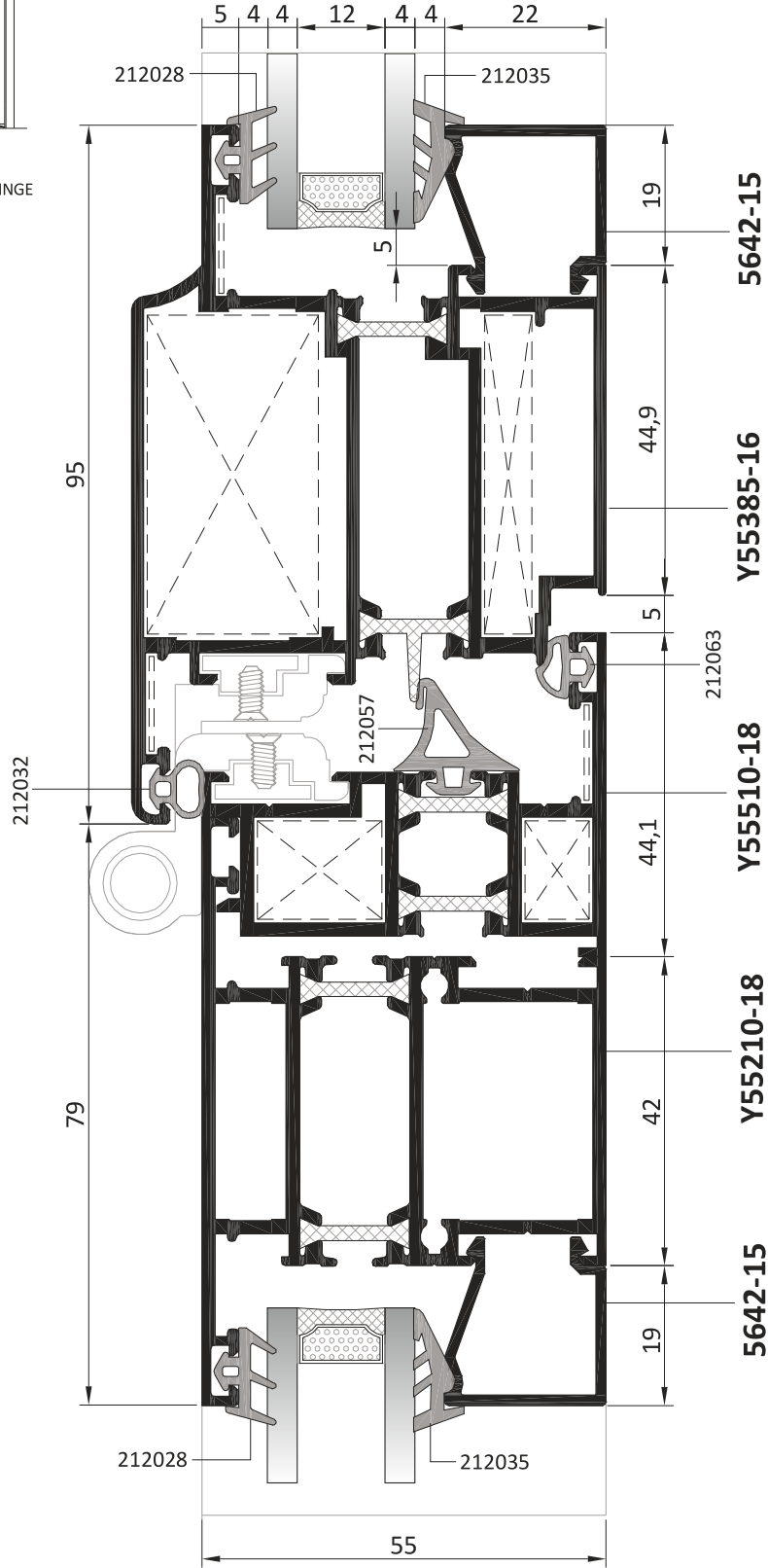

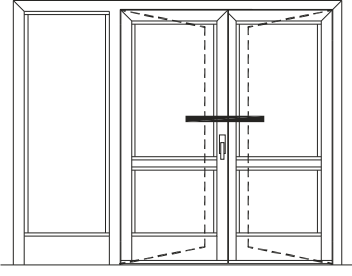

DİŞA AÇILIR BİNİLİ KAPI
OUTWARD OPENING DOOR WITH STEP HINGE

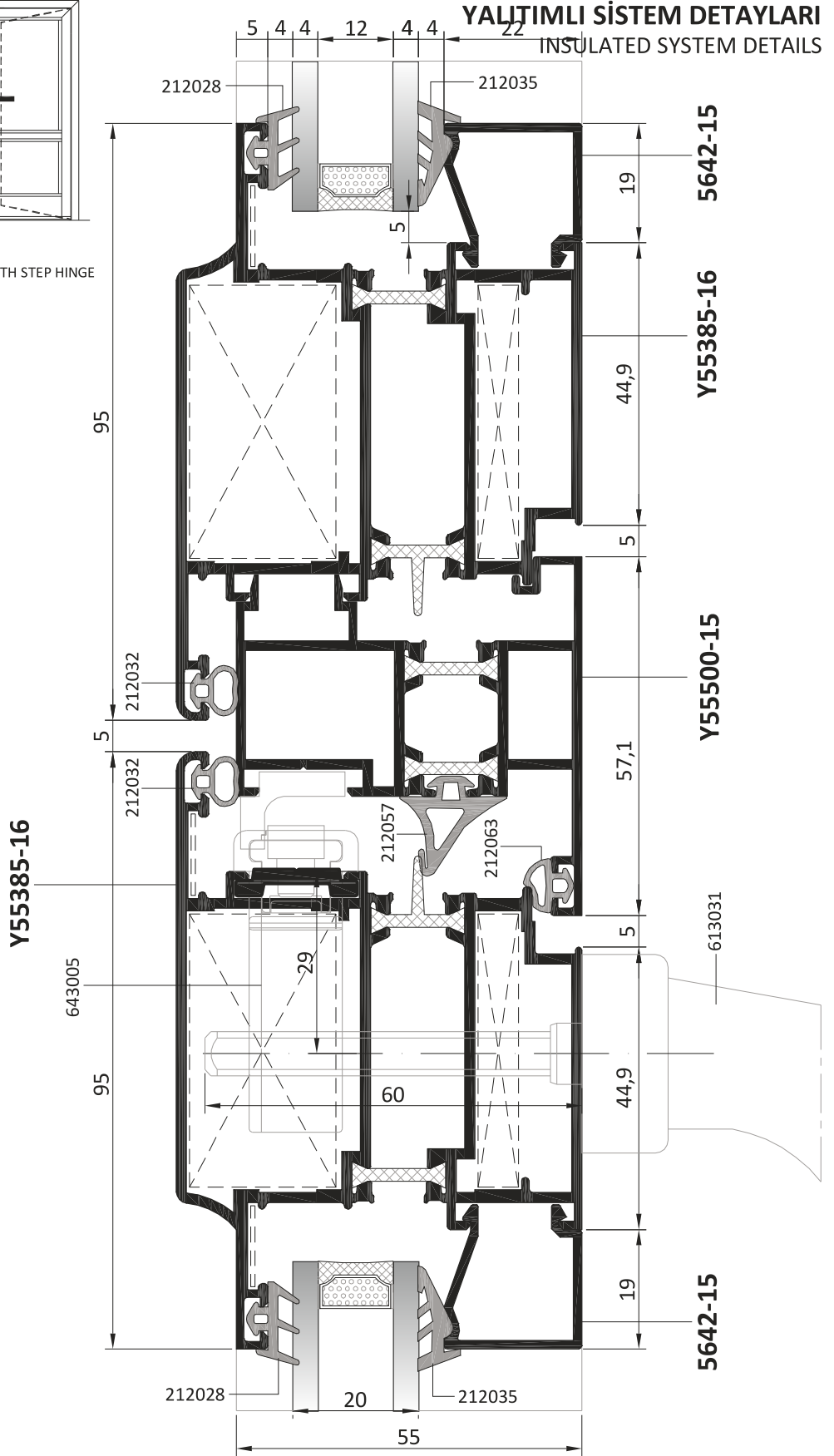

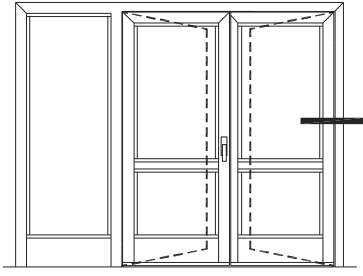

DIŐA AÇILIR BİNİLİ KAPI
OUTWARD OPENING DOOR WITH STEP HINGE

YALITIMLI SİSTEM DETAYLARI

INSULATED SYSTEM DETAILS

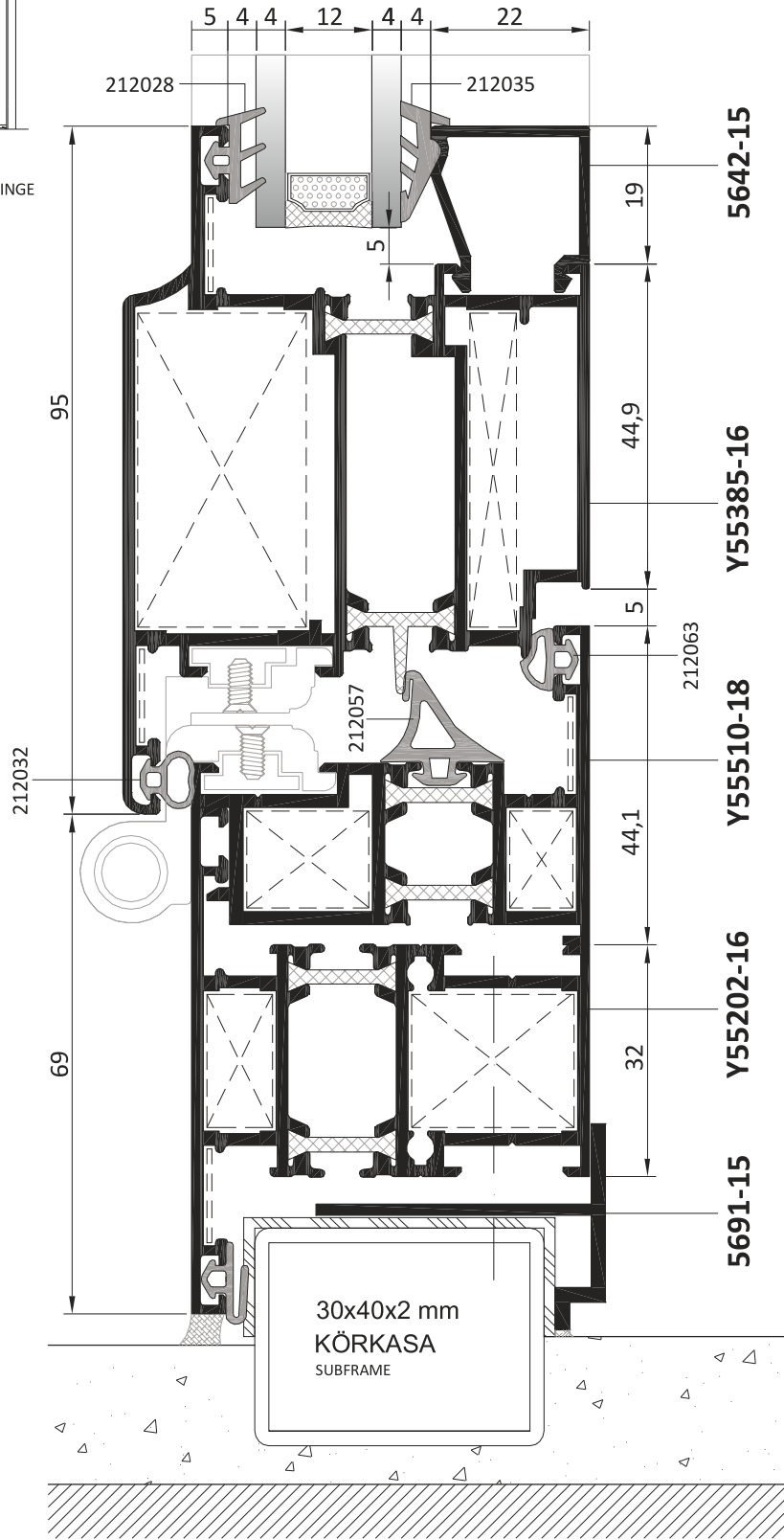

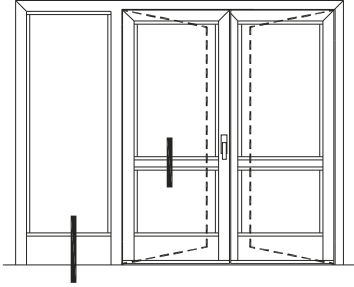

DIŐA AÇILIR BİNİLİ KAPI
OUTWARD OPENING DOOR WITH STEP HINGE

YALITIMLI SİSTEM DETAYLARI
INSULATED SYSTEM DETAILS

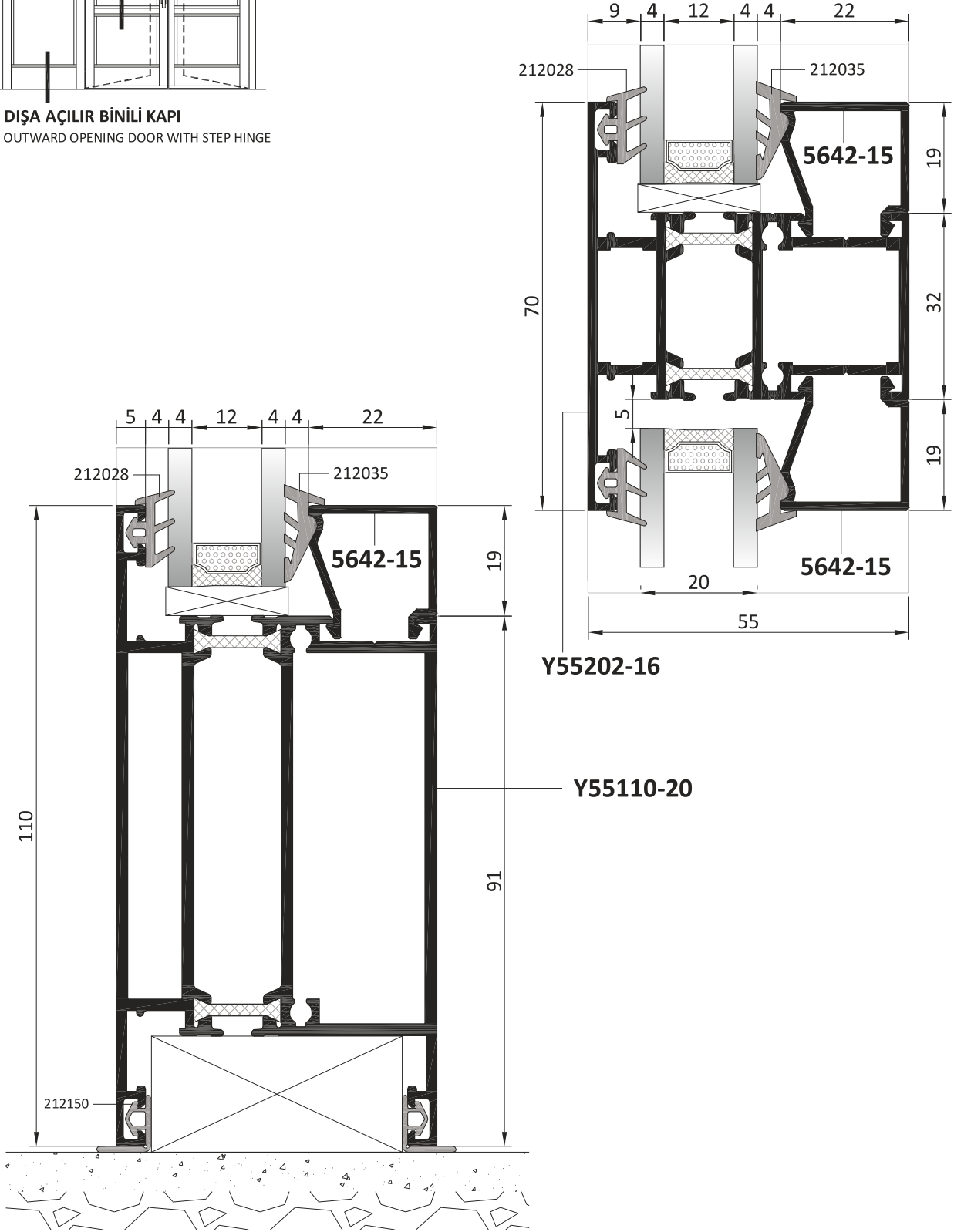

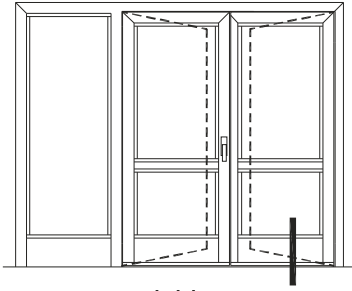

DIŐA AÇILIR BİNİLİ KAPI
OUTWARD OPENING DOOR WITH STEP HINGE

YALITIMLI SİSTEM DETAYLARI
INSULATED SYSTEM DETAILS

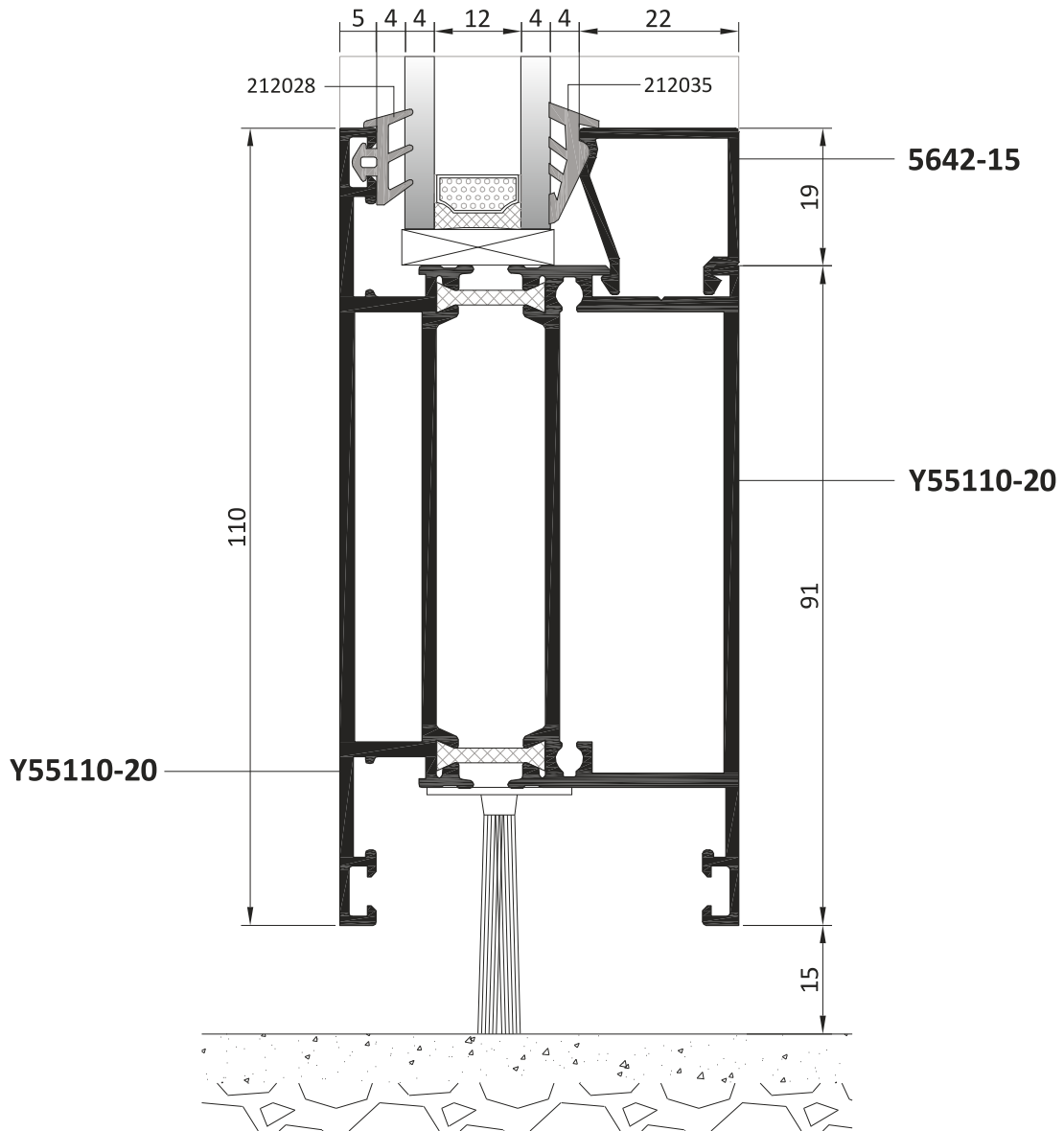

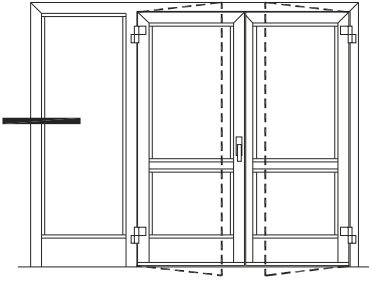

İÇE AÇILIR HEMYÜZ KAPI
INWARD OPENING FLUSH DOOR

YALITIMLI SİSTEM DETAYLARI
INSULATED SYSTEM DETAILS

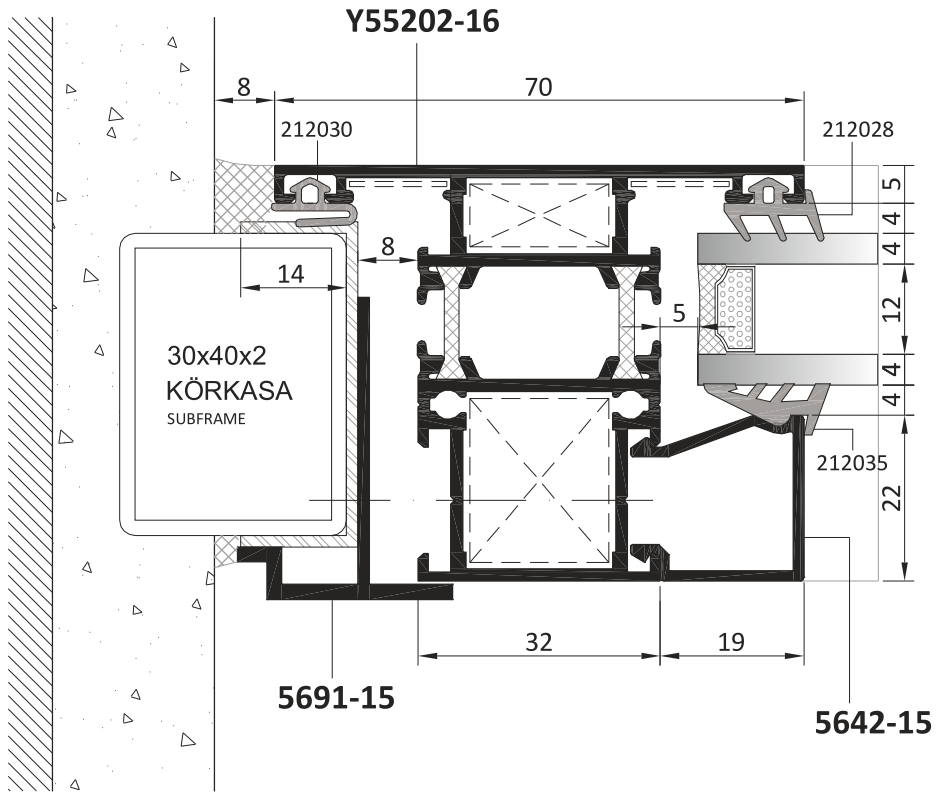

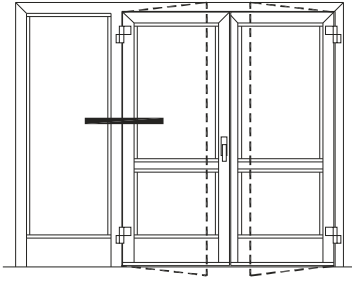

İÇE AÇILIR HEMYÜZ KAPI
INWARD OPENING FLUSH DOOR

YALITIMLI SİSTEM DETAYLARI

INSULATED SYSTEM DETAILS

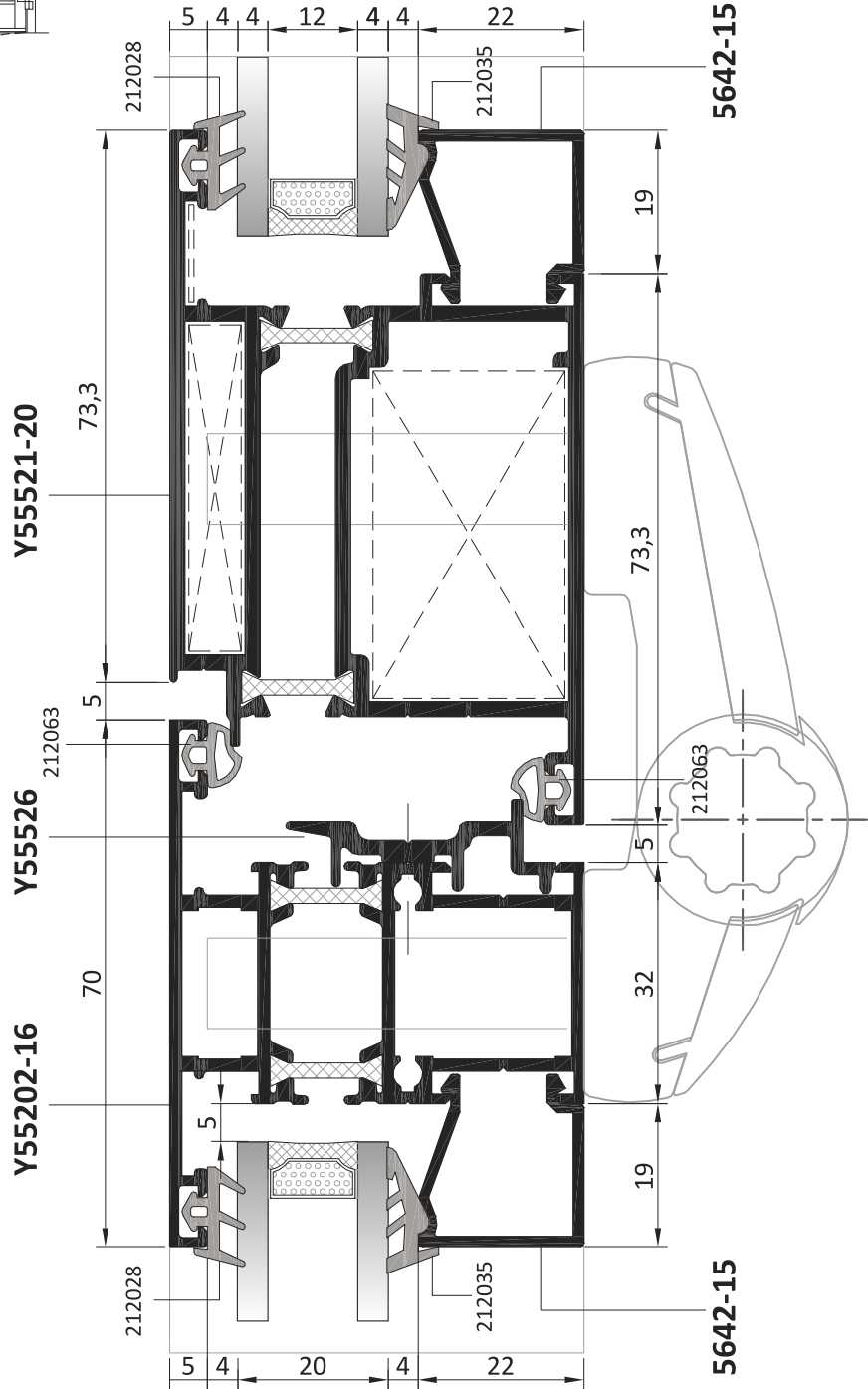

YALITIMLI SİSTEM DETAYLARI INSULATED SYSTEM DETAILS

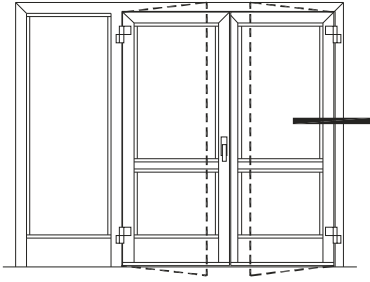

İÇE AÇILIR HEMYÜZ KAPI
INWARD OPENING FLUSH DOOR

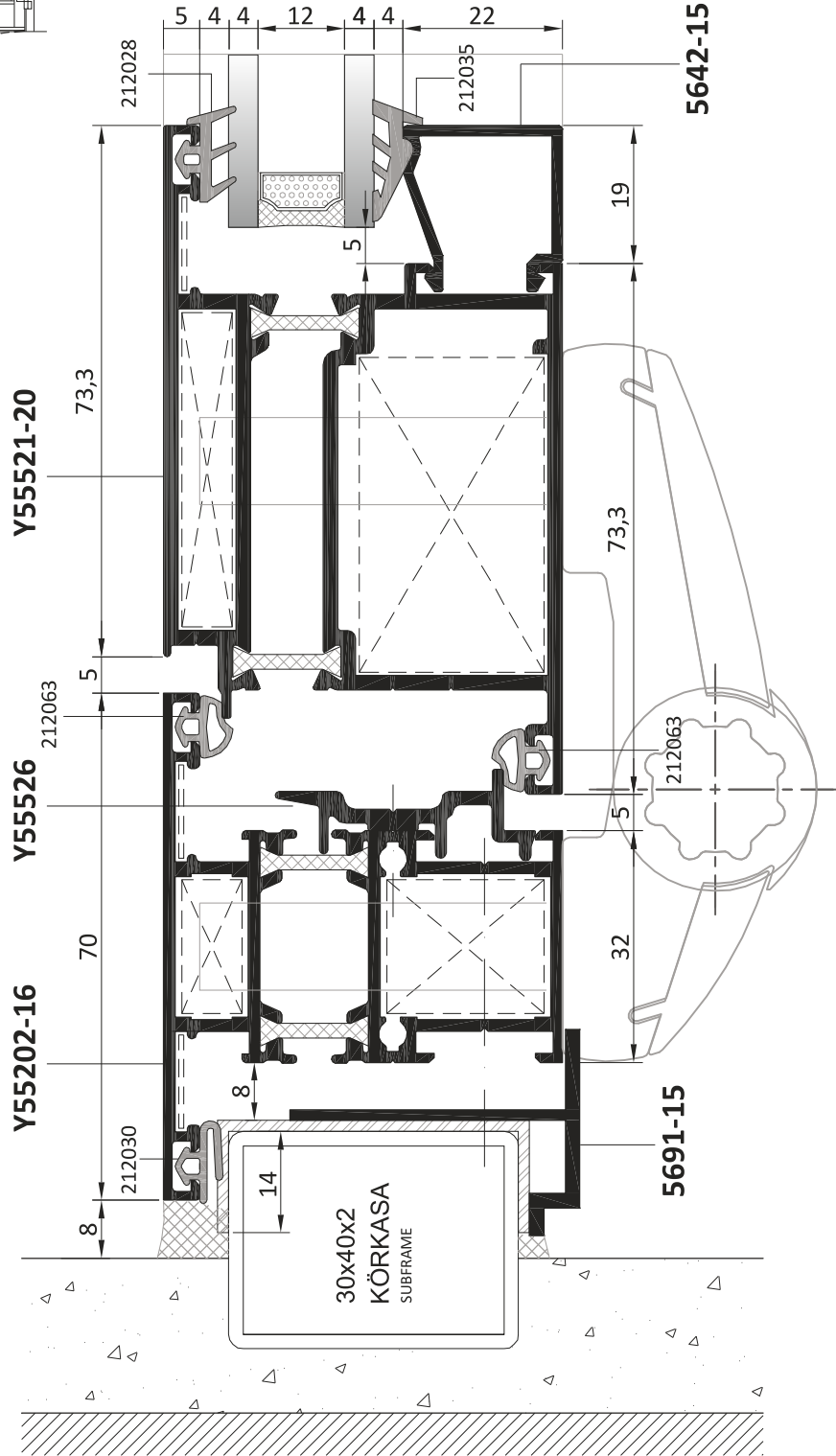

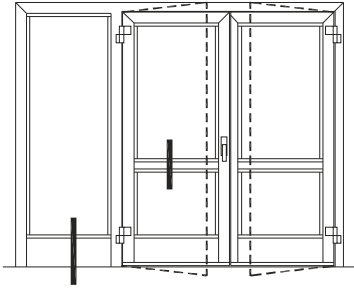

İÇE AÇILIR HEMİYÜZ KAPI
INWARD OPENING FLUSH DOOR

YALITIMLI SİSTEM DETAYLARI
INSULATED SYSTEM DETAILS

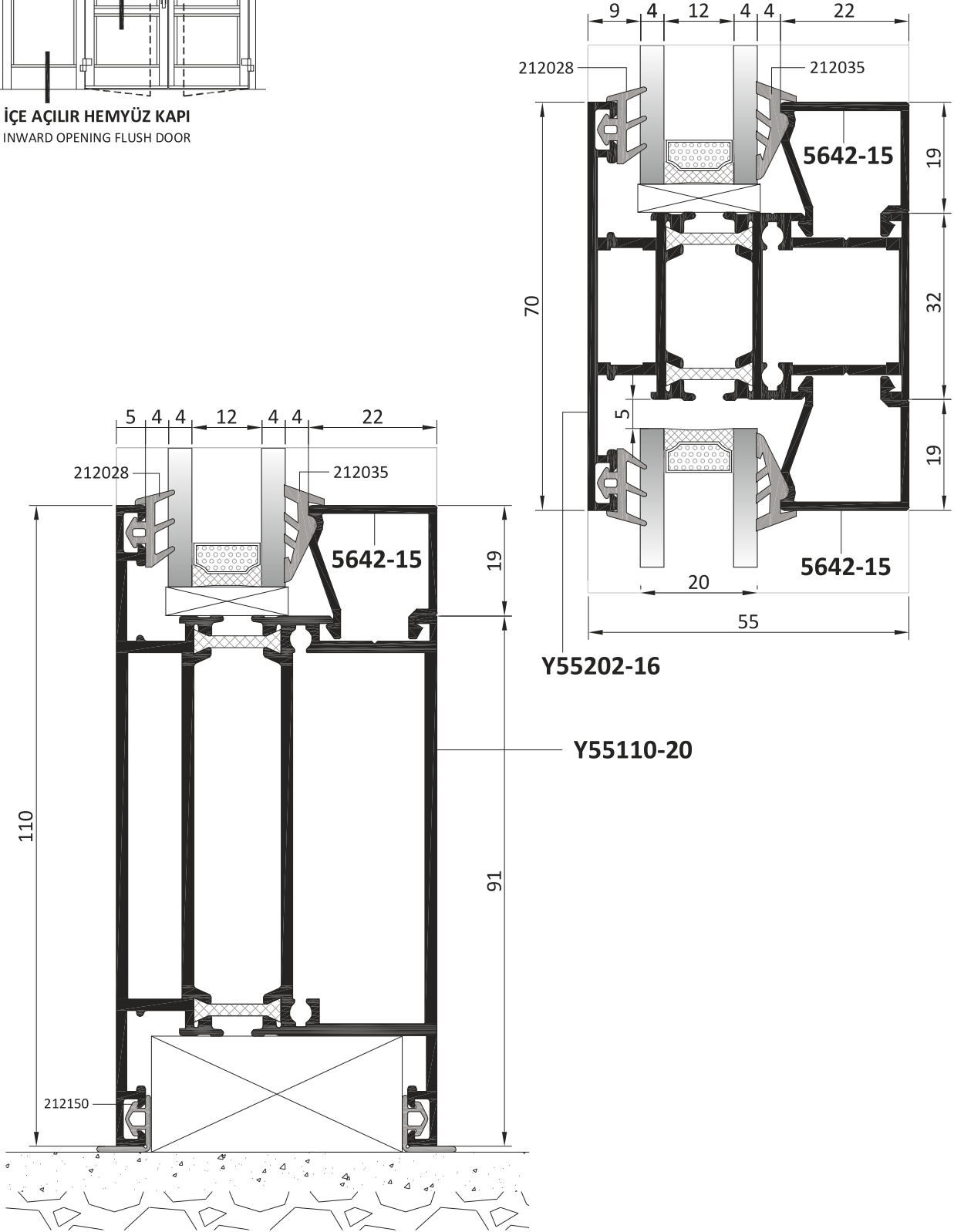

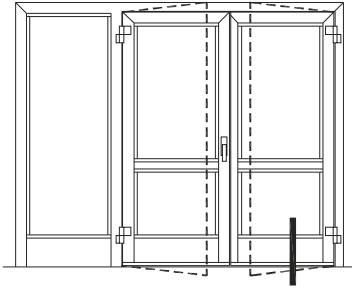

İÇE AÇILIR HEMYÜZ KAPI
INWARD OPENING FLUSH DOOR

YALITIMLI SİSTEM DETAYLARI INSULATED SYSTEM DETAILS

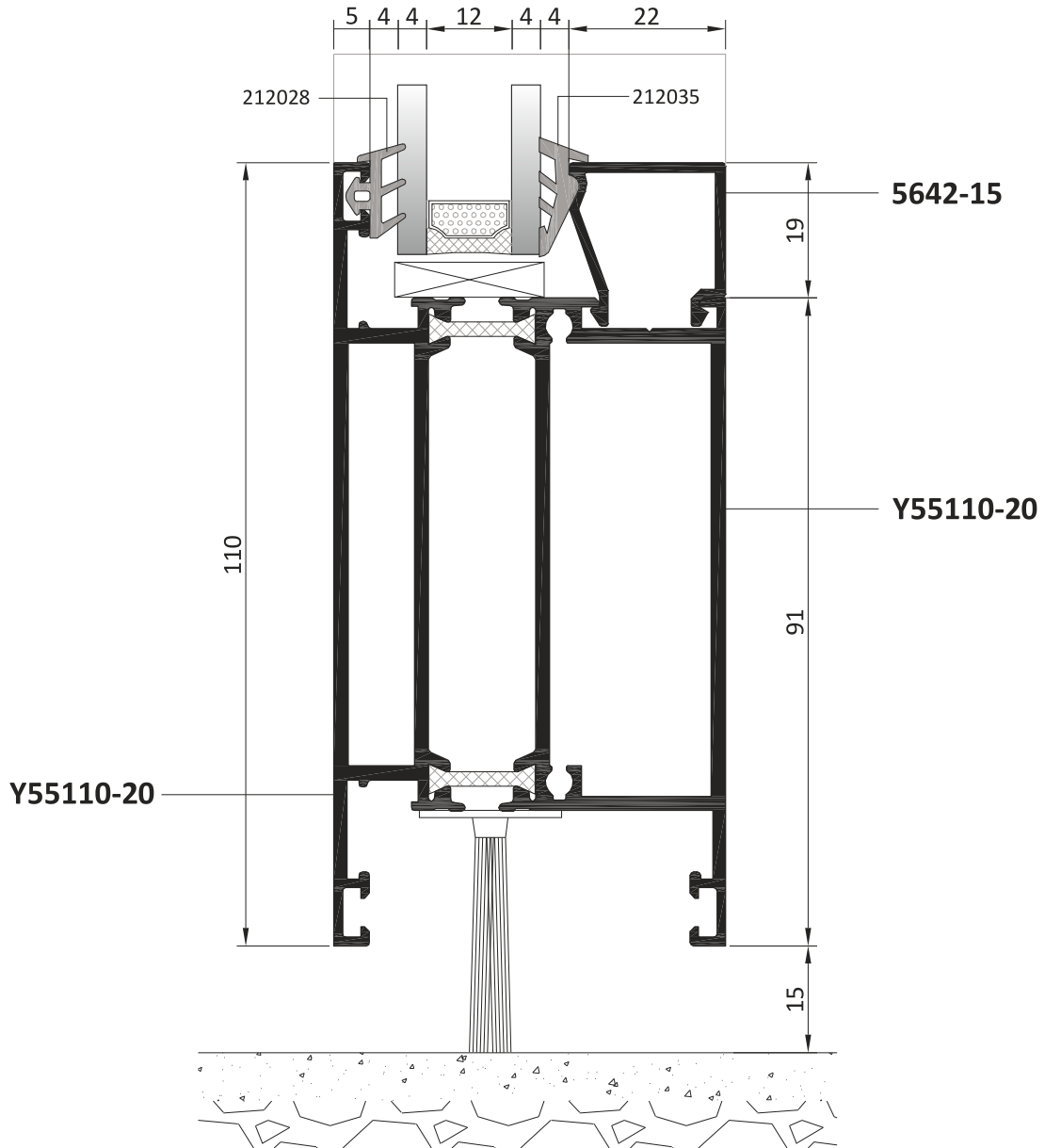

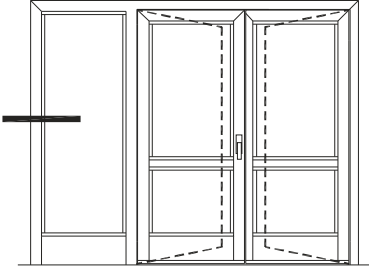

DIŐA AÇILIR HEMYÜZ KAPI
OUTWARD OPENING FLUSH DOOR

YALITIMLI SİSTEM DETAYLARI
INSULATED SYSTEM DETAILS

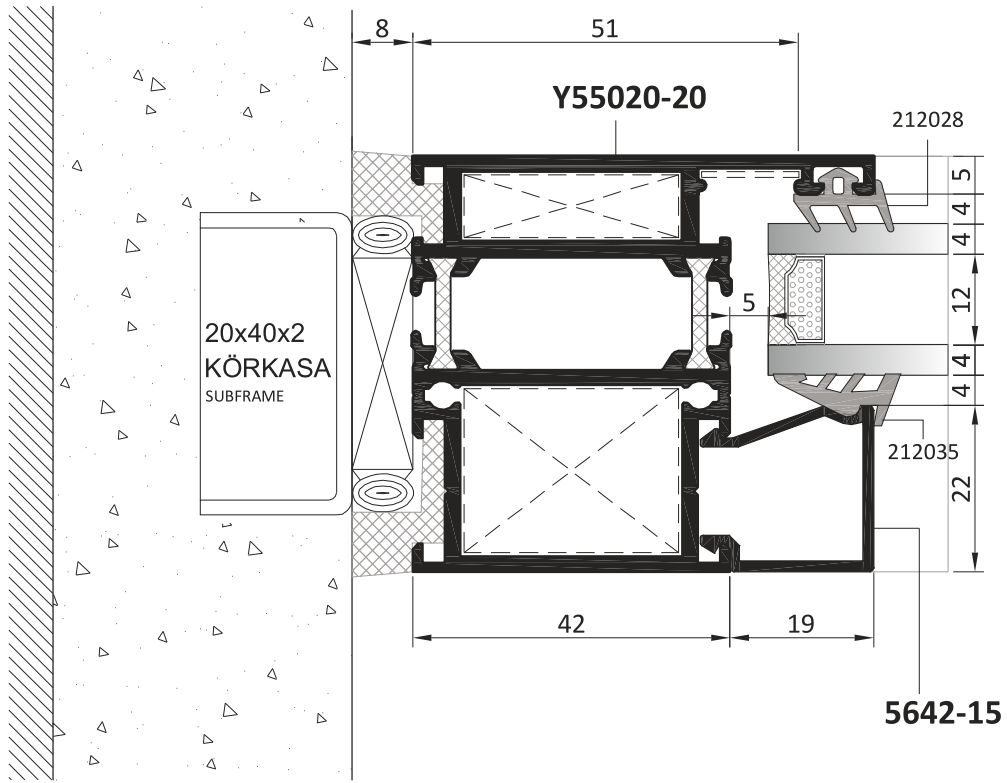

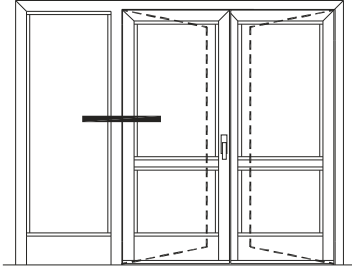

DIŐA AÇILIR HEMYÜZ KAPI
OUTWARD OPENING FLUSH DOOR

YALITIMLI SİSTEM DETAYLARI

INSULATED SYSTEM DETAILS

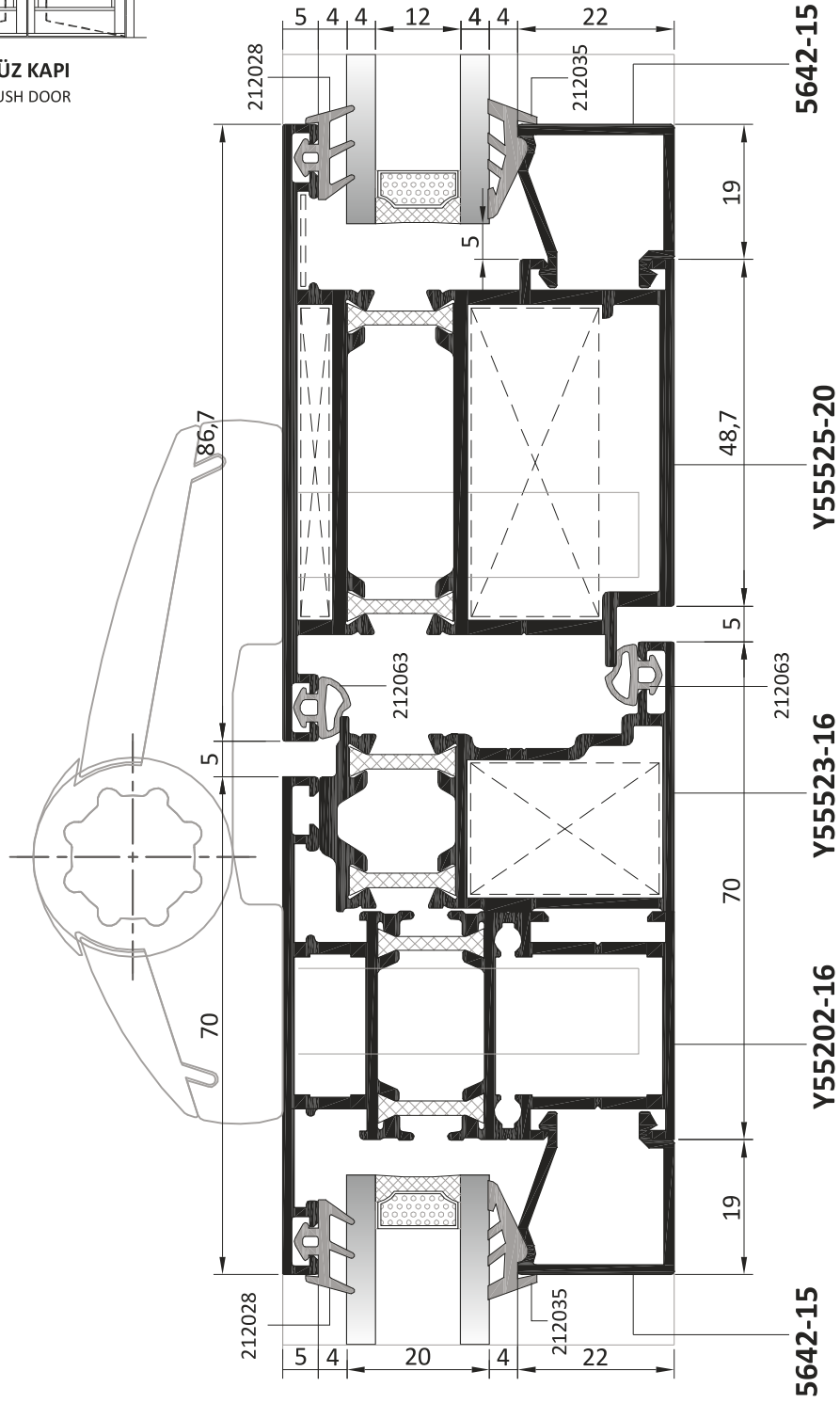

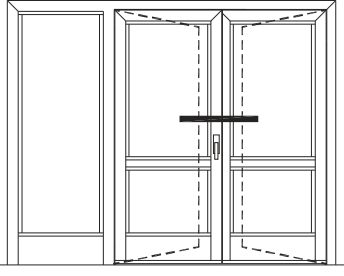

DIŐA AÇILIR HEMYÜZ KAPI
OUTWARD OPENING FLUSH DOOR

YALITIMLI SİSTEM DETAYLARI
INSULATED SYSTEM DETAILS

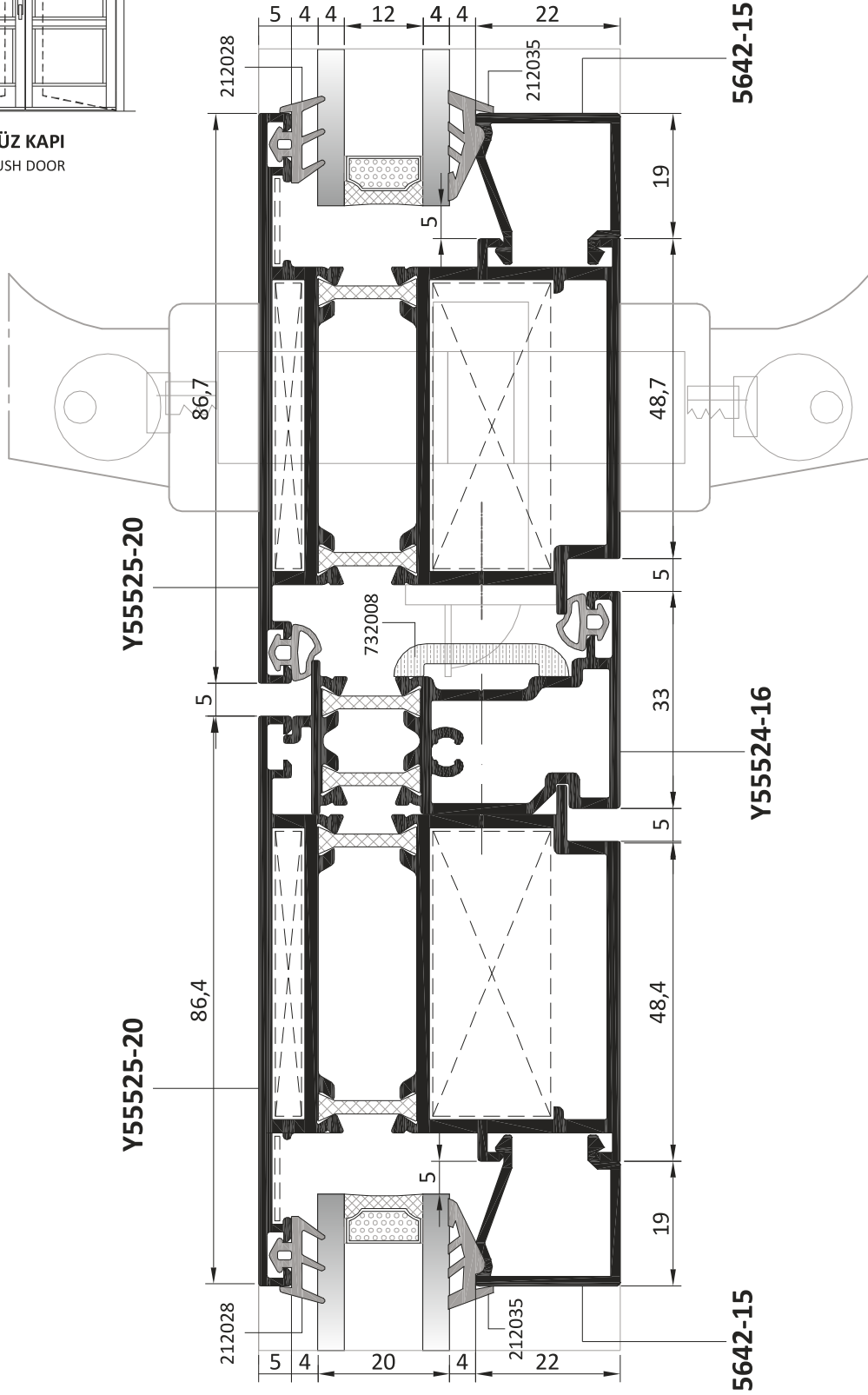

YALITIMLI SİSTEM DETAYLARI INSULATED SYSTEM DETAILS

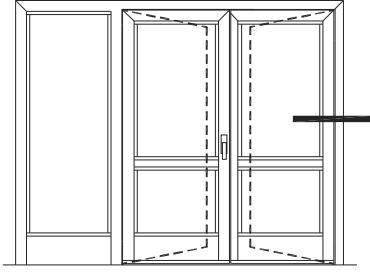

DIŞA AÇILIR HEMYÜZ KAPI
OUTWARD OPENING FLUSH DOOR

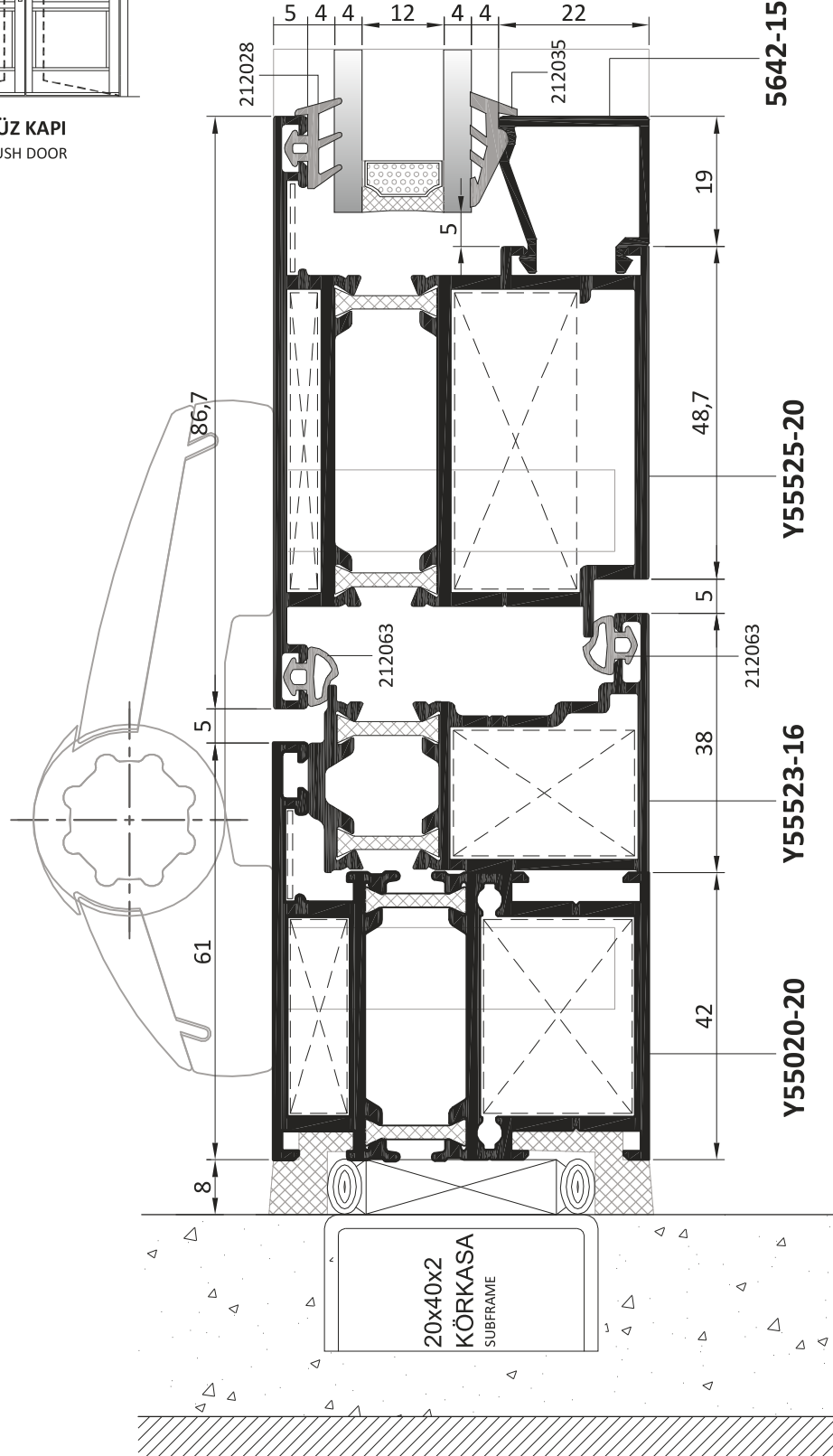

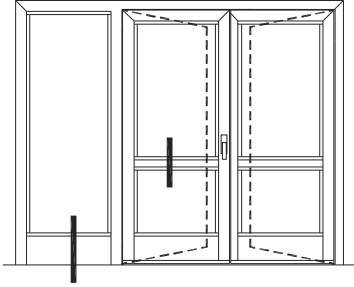

DIŐA AÇILIR HEMYÜZ KAPI
OUTWARD OPENING FLUSH DOOR

YALITIMLI SİSTEM DETAYLARI
INSULATED SYSTEM DETAILS

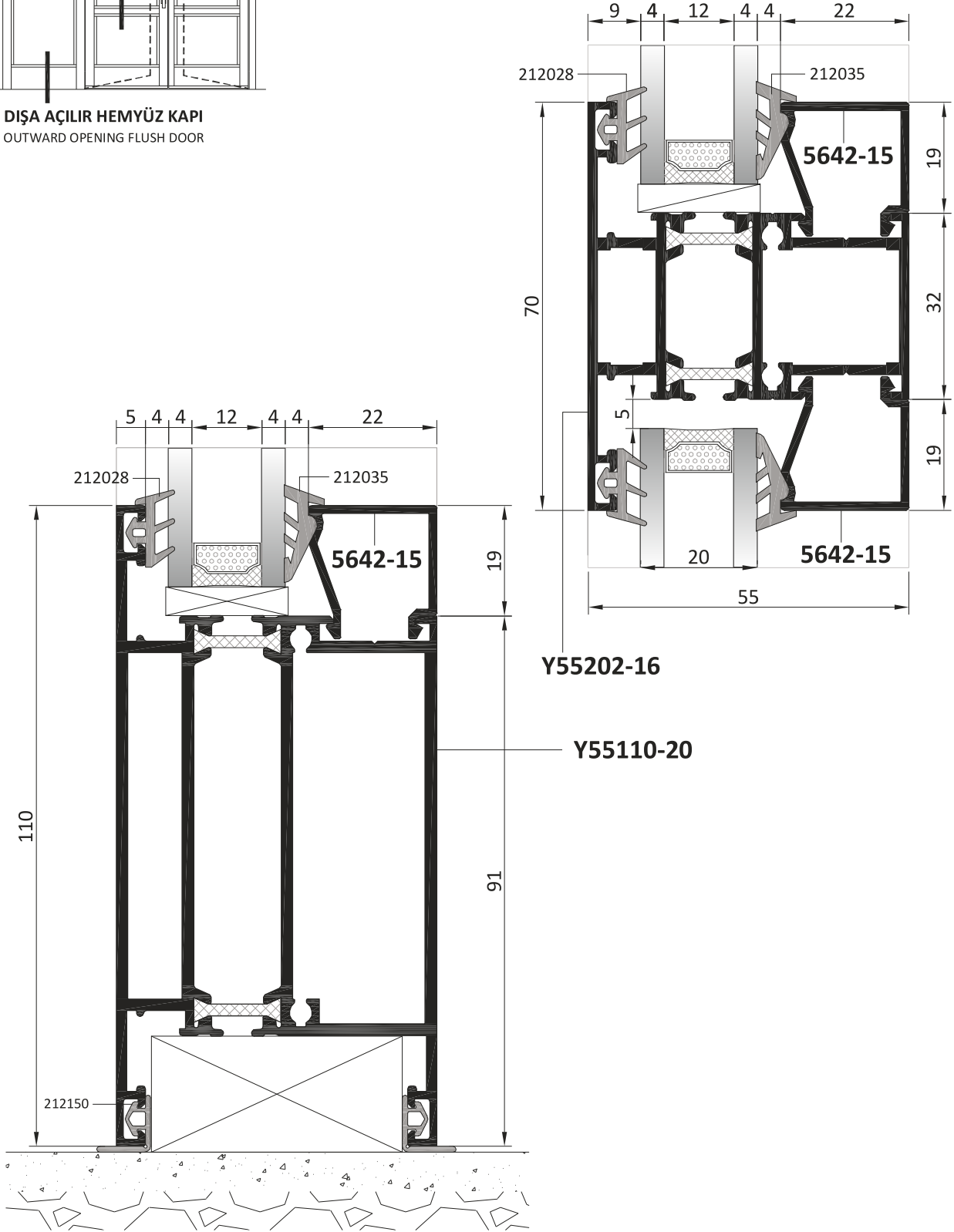

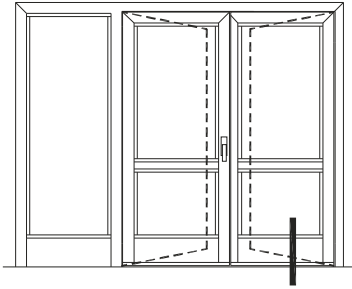

DIŐA AÇILIR HEMYÜZ KAPI
OUTWARD OPENING FLUSH DOOR

YALITIMLI SİSTEM DETAYLARI
INSULATED SYSTEM DETAILS

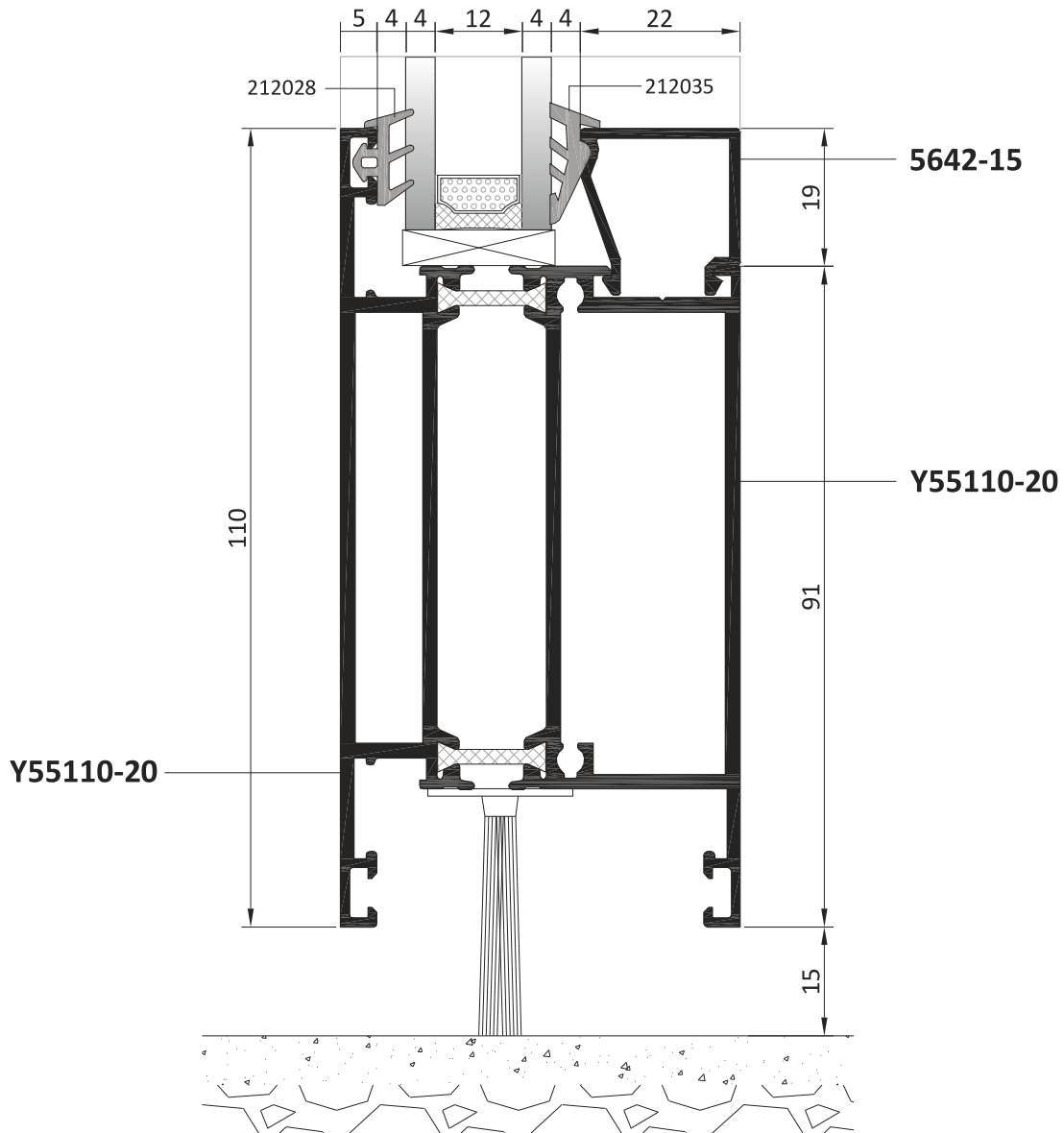

YALITIMSIZ SİSTEM DETAYLARI

UNINSULATED SYSTEM DETAILS

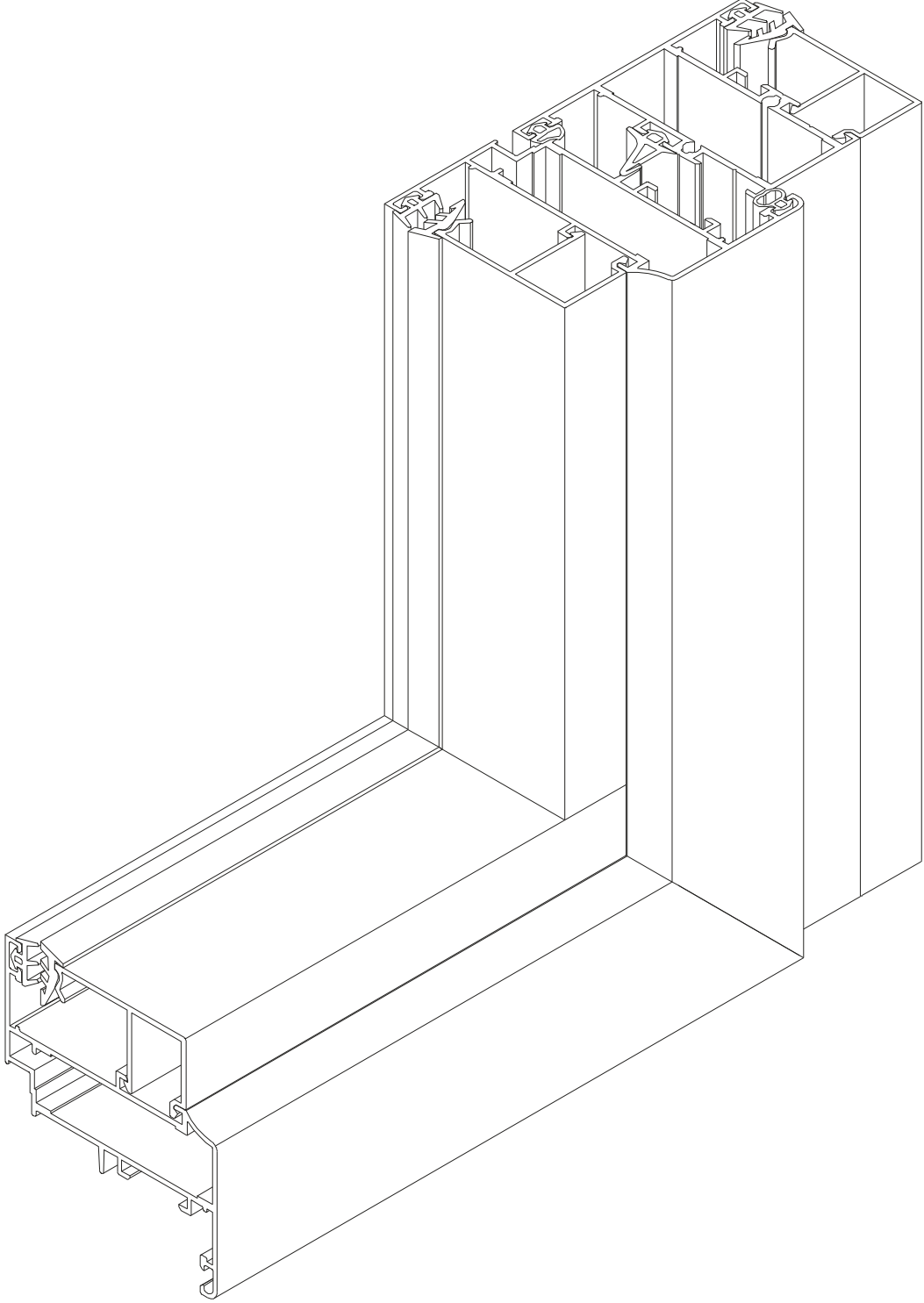
2

102

YALITIMSIZ SİSTEM DETAYLARI UNINSULATED SYSTEM DETAILS

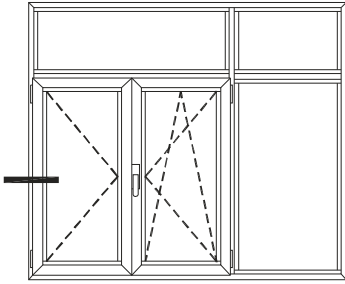

İÇE AÇILIR PENCERE
INWARD OPENING WINDOW

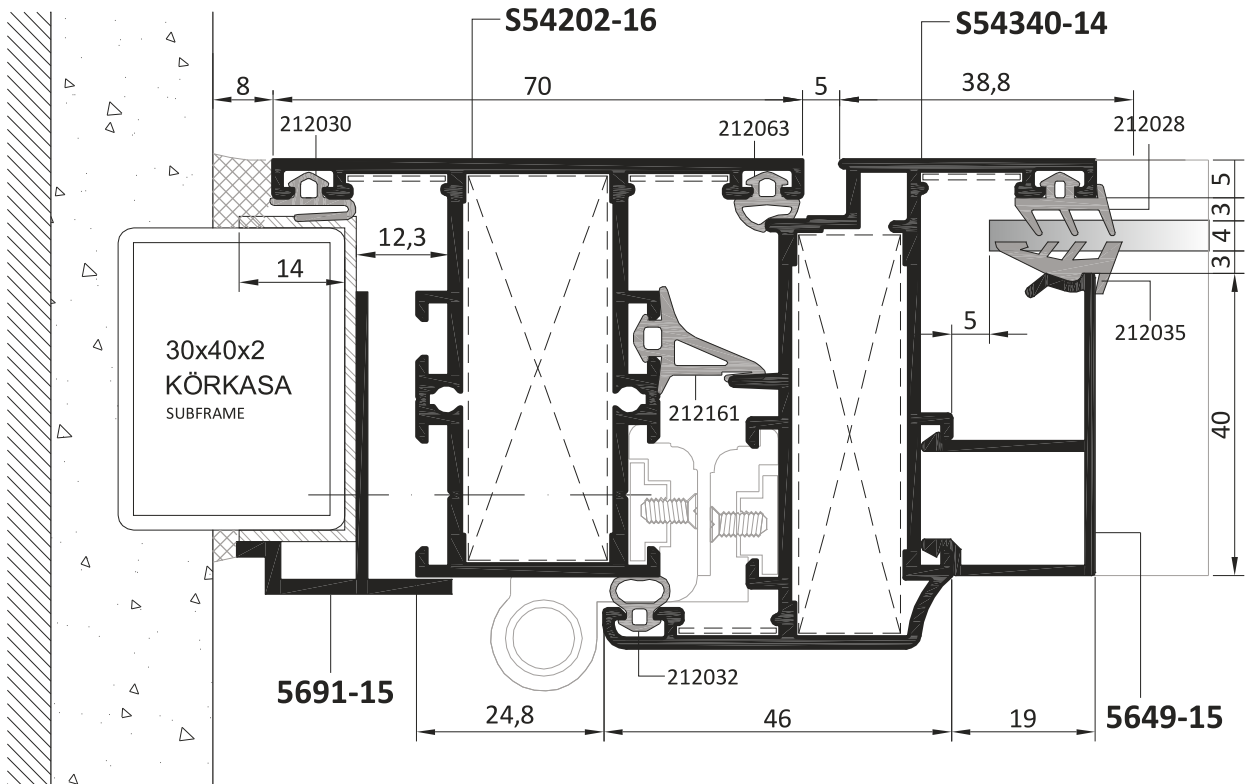
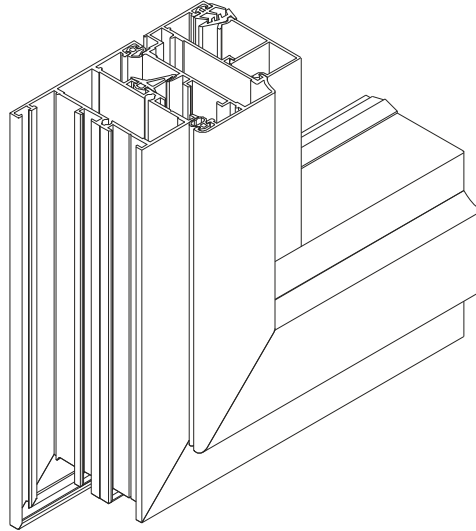

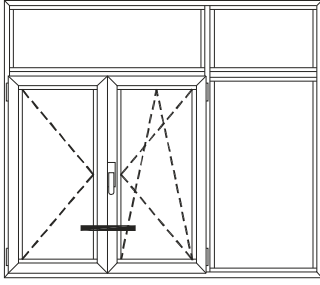

İÇE AÇILIR PENCERE
INWARD OPENING WINDOW

YALITIMSIZ SİSTEM DETAYLARI
UNINSULATED SYSTEM DETAILS

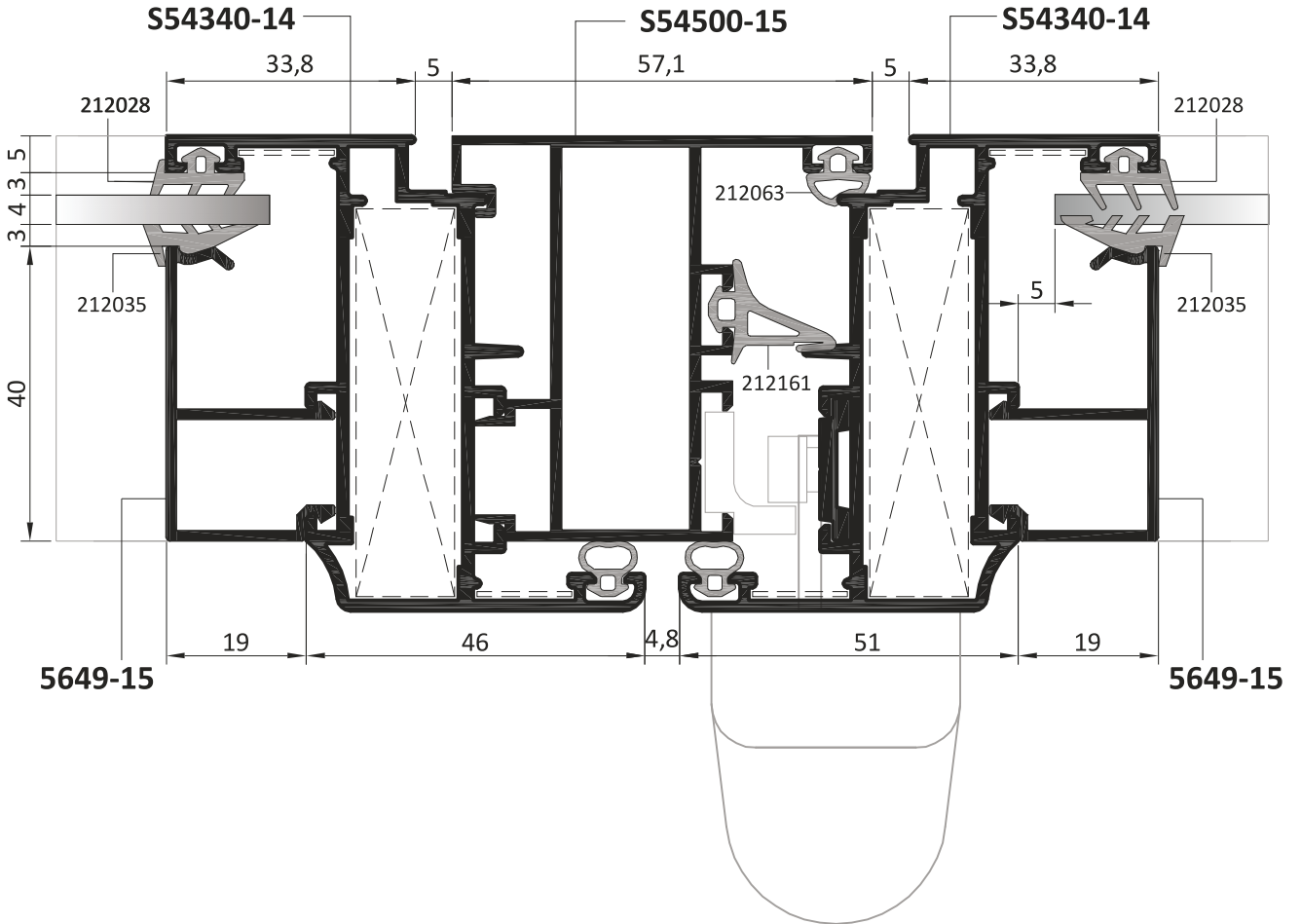
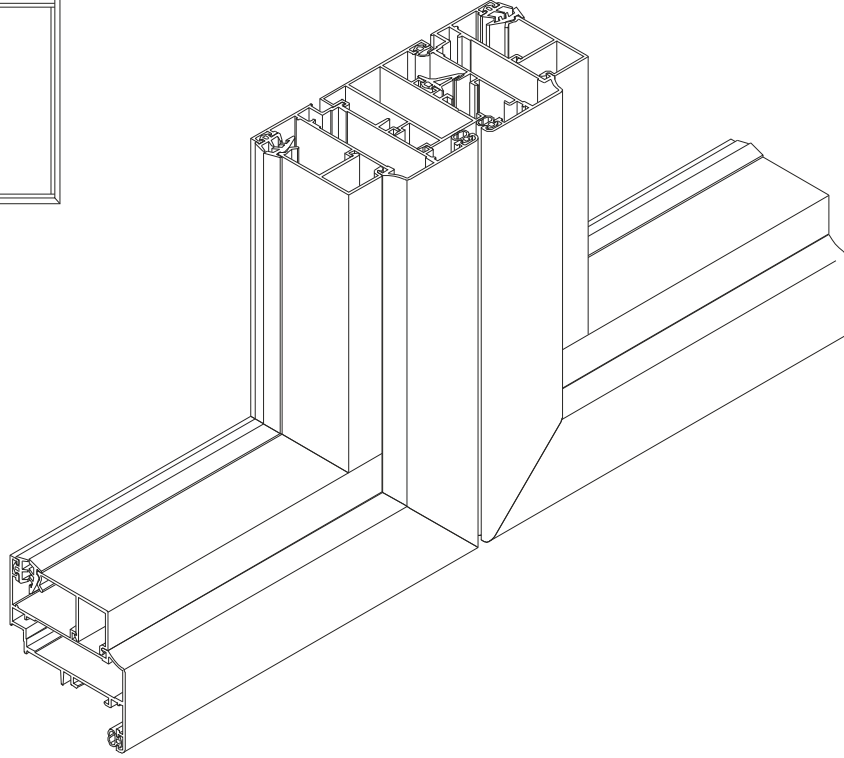

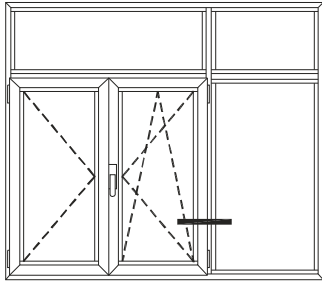

İÇE AÇILIR PENCERE
INWARD OPENING WINDOW

YALITIMSIZ SİSTEM DETAYLARI

UNINSULATED SYSTEM DETAILS

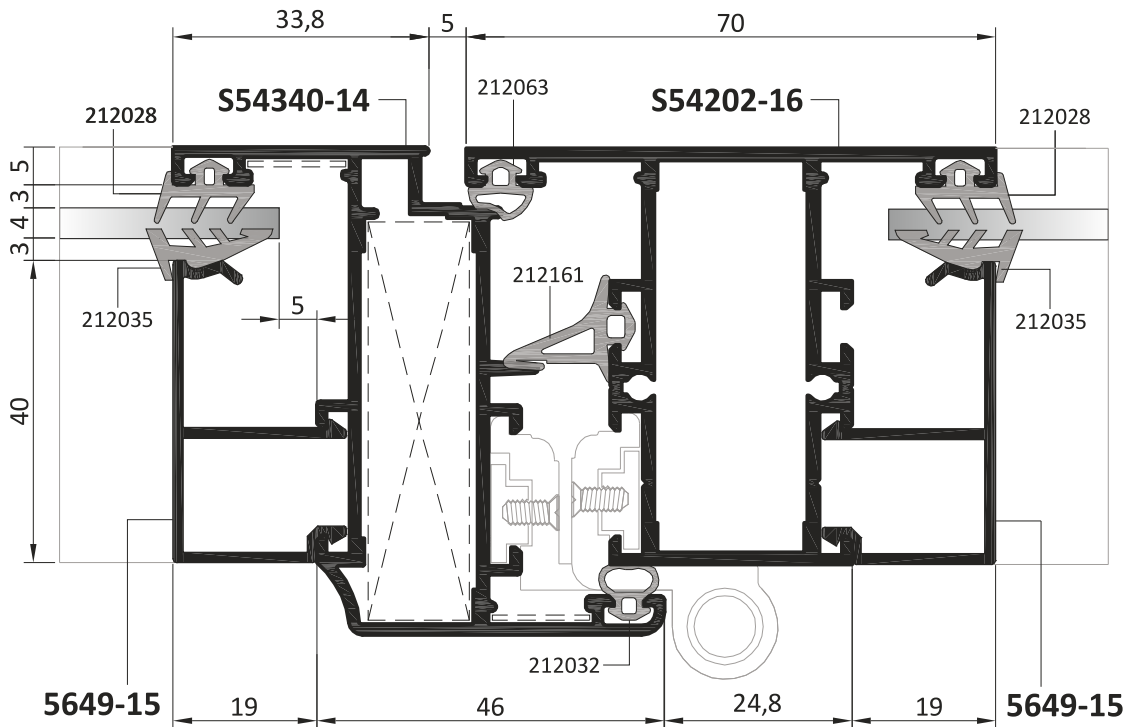
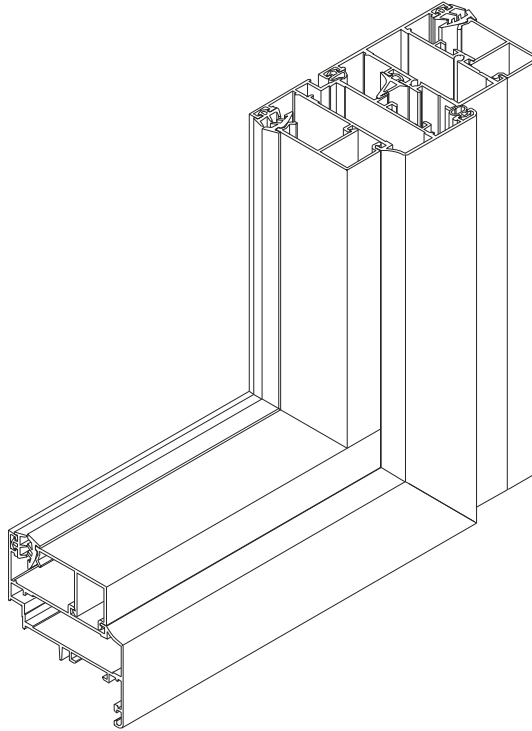

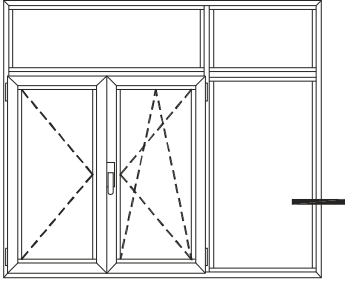

İÇE AÇILIR PENCERE
INWARD OPENING WINDOW

YALITIMSIZ SİSTEM DETAYLARI
UNINSULATED SYSTEM DETAILS

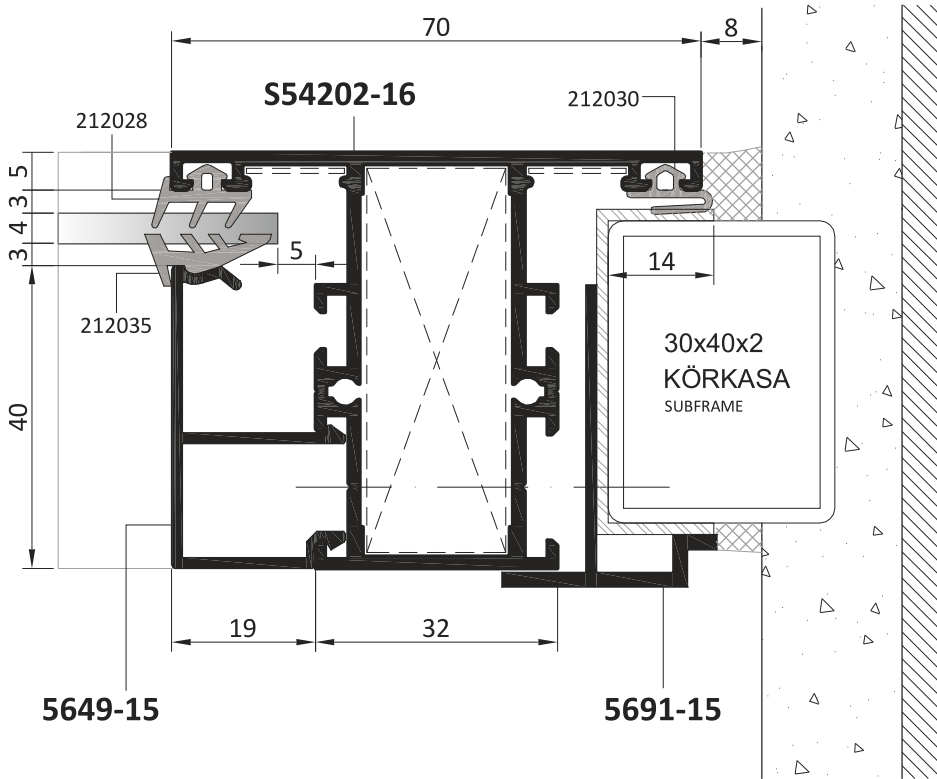
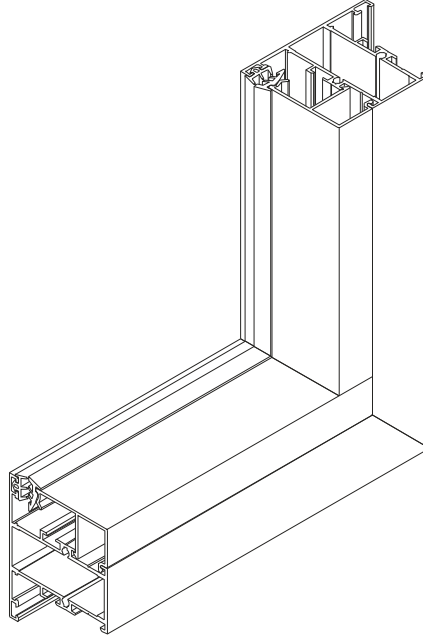

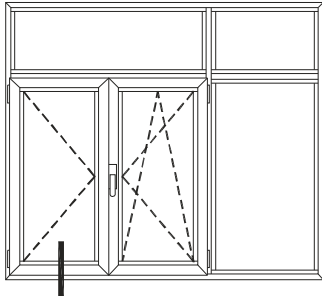

İÇE AÇILIR PENCERE
INWARD OPENING WINDOW

YALITIMSIZ SİSTEM DETAYLARI UNINSULATED SYSTEM DETAILS

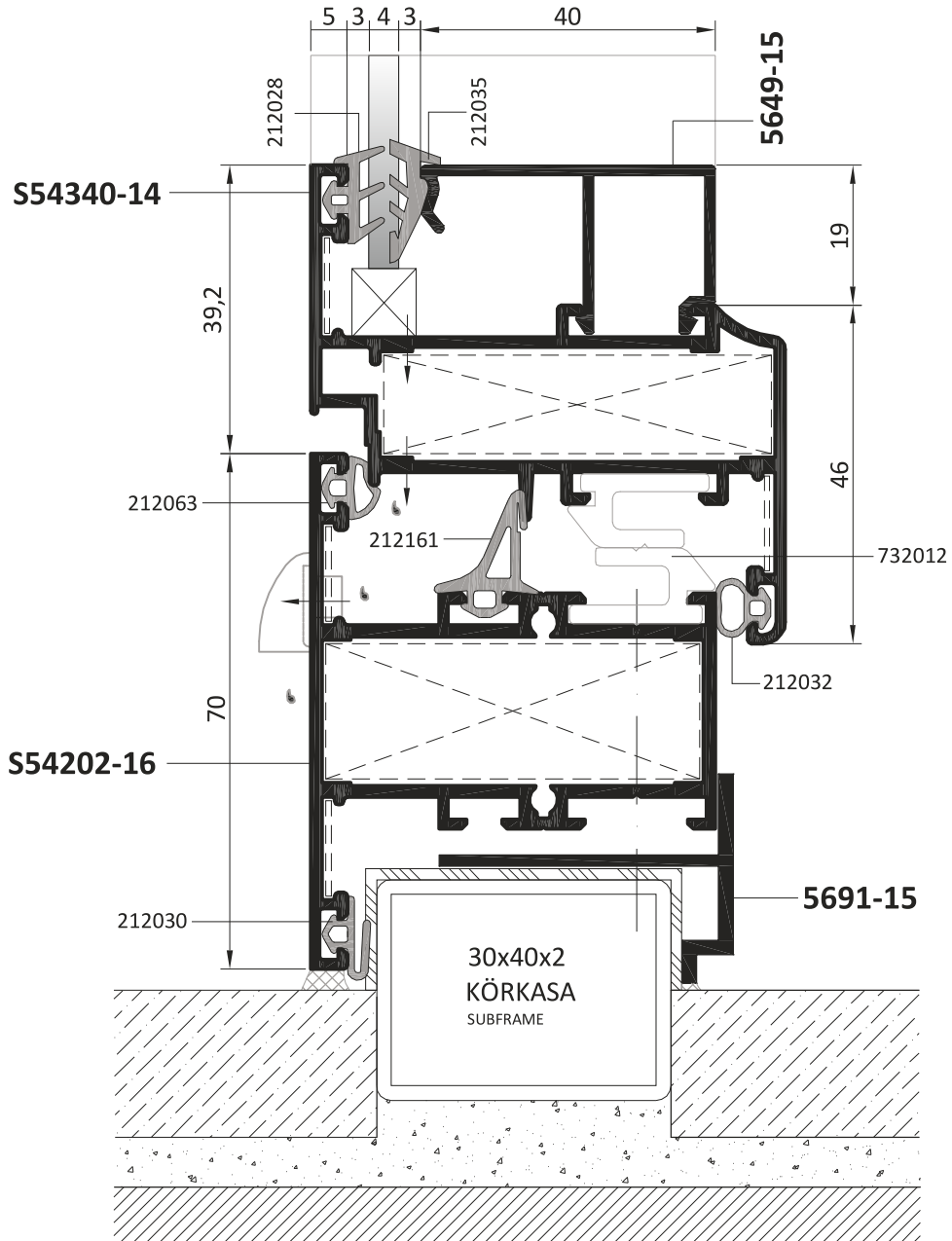

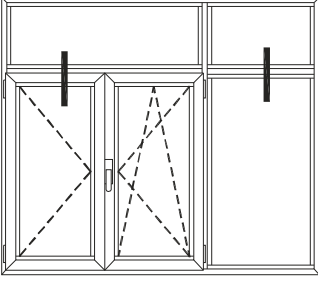

İÇE AÇILIR PENCERE
INWARD OPENING WINDOW

YALITIMSIZ SİSTEM DETAYLARI
UNINSULATED SYSTEM DETAILS

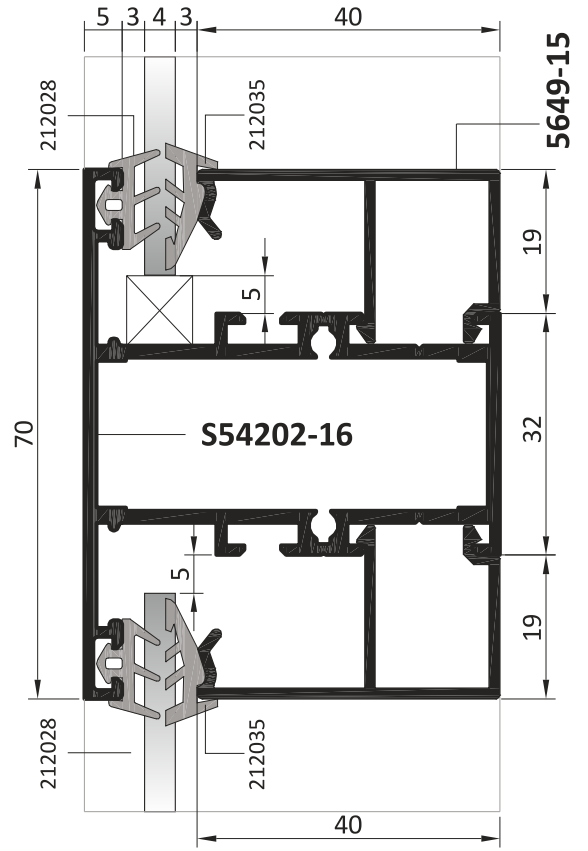
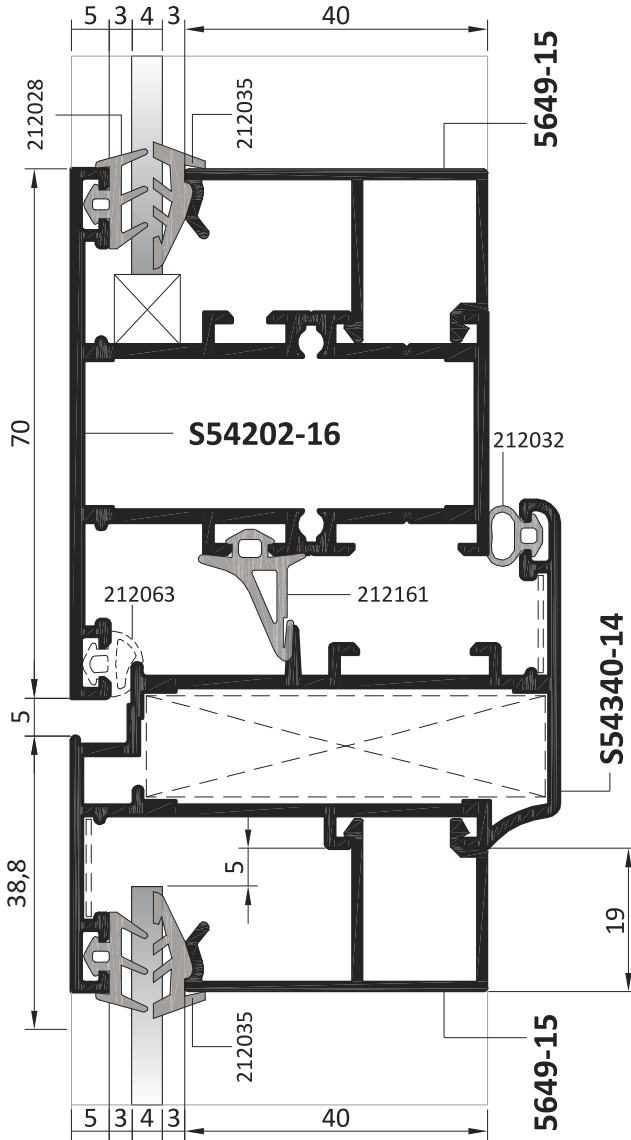

ÖNEMLİ / IMPORTANT

DETAY ÜZERİNDE BELİRTİLMİŞ OLAN
212063 KODLU FİTİL HER KANAT İÇİN
ÜSTTEN 5cm KERTİLMELİDİR.

GASKET NO: 212063 SHOULD BE NOTCHED AT
THE TOP FOR EACH VENTS 5cm AS SHOWN ON
THE DETAIL.

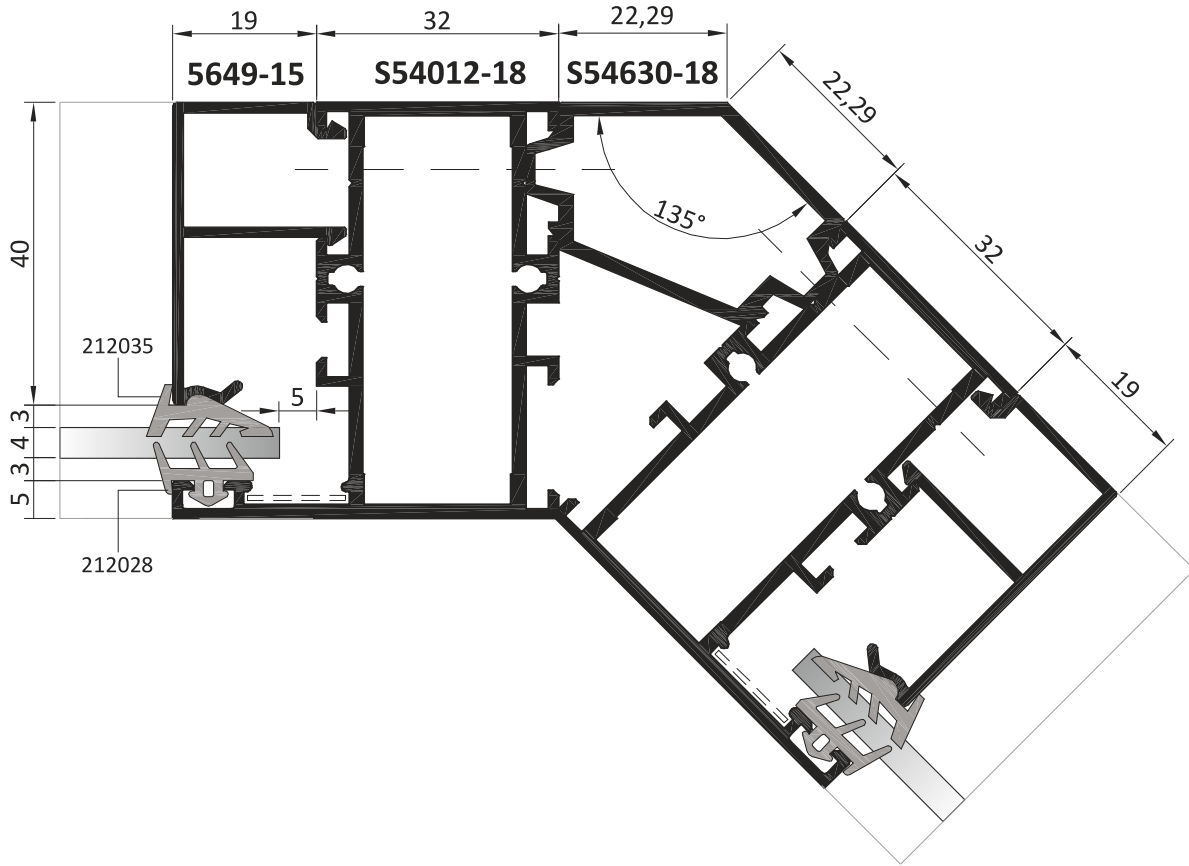
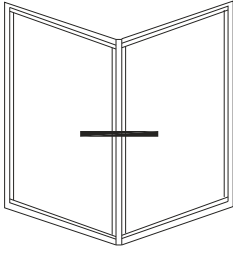
KÖŞE DÖNÜŞ DİLATASYON DETAYI
CORNER DILATATION DETAIL

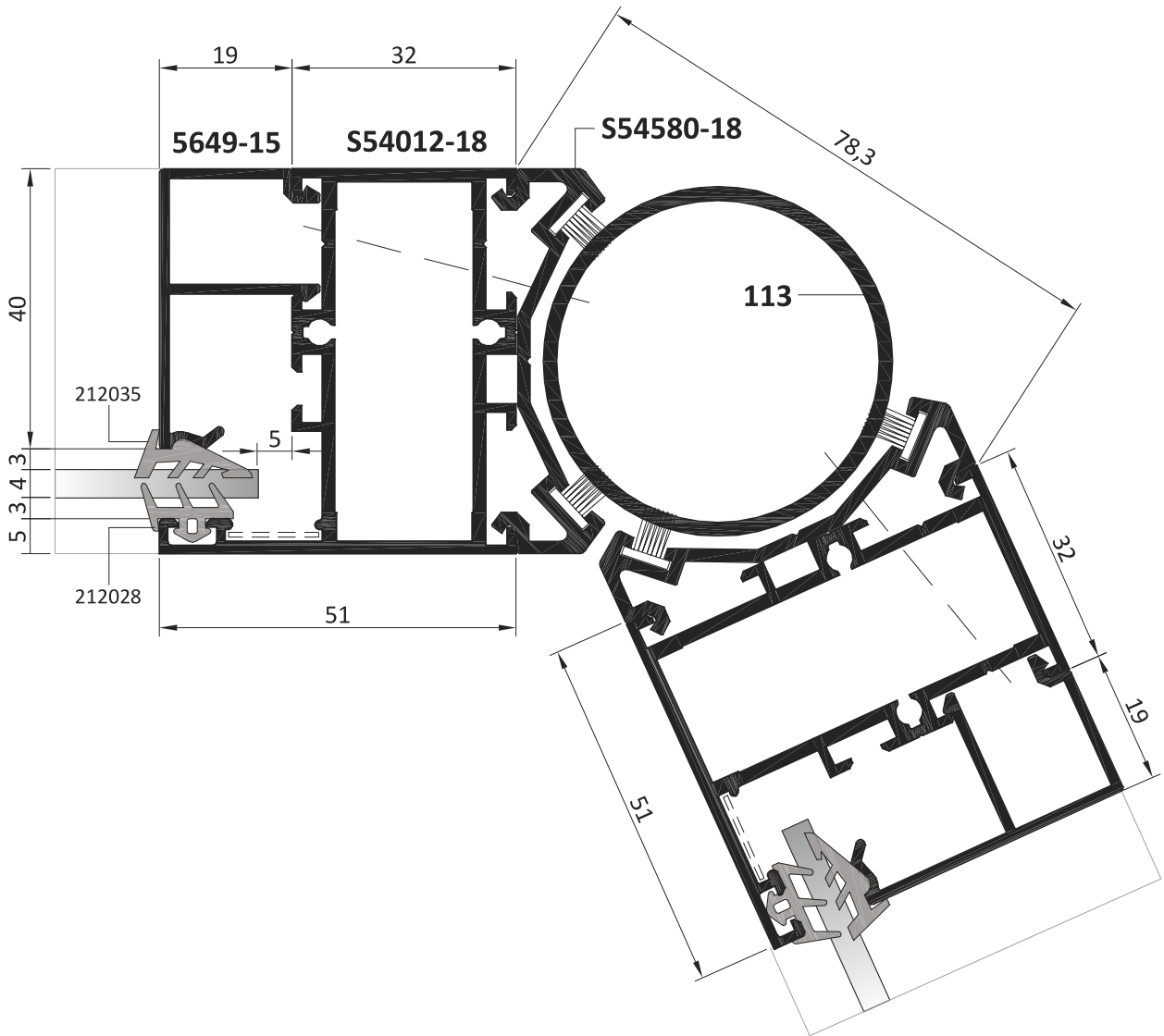
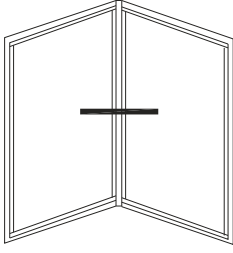
KÖŞE DÖNÜŞ DİLATASYON DETAYI
CORNER DILATATION DETAIL

110

KÖŞE DÖNÜŞ DİLATASYON DETAYI CORNER DILATATION DETAIL

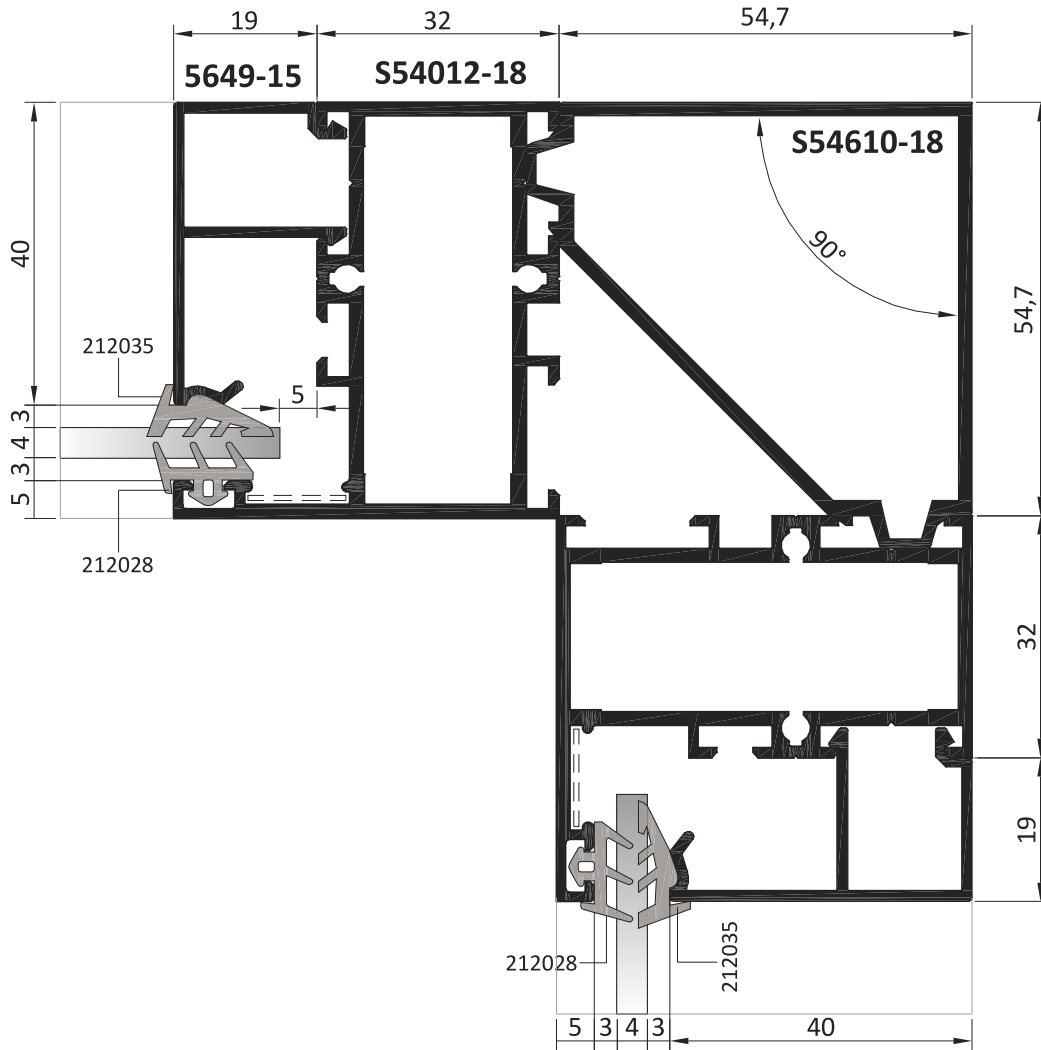
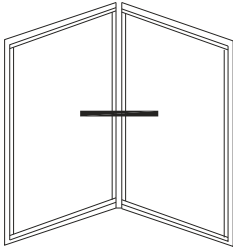

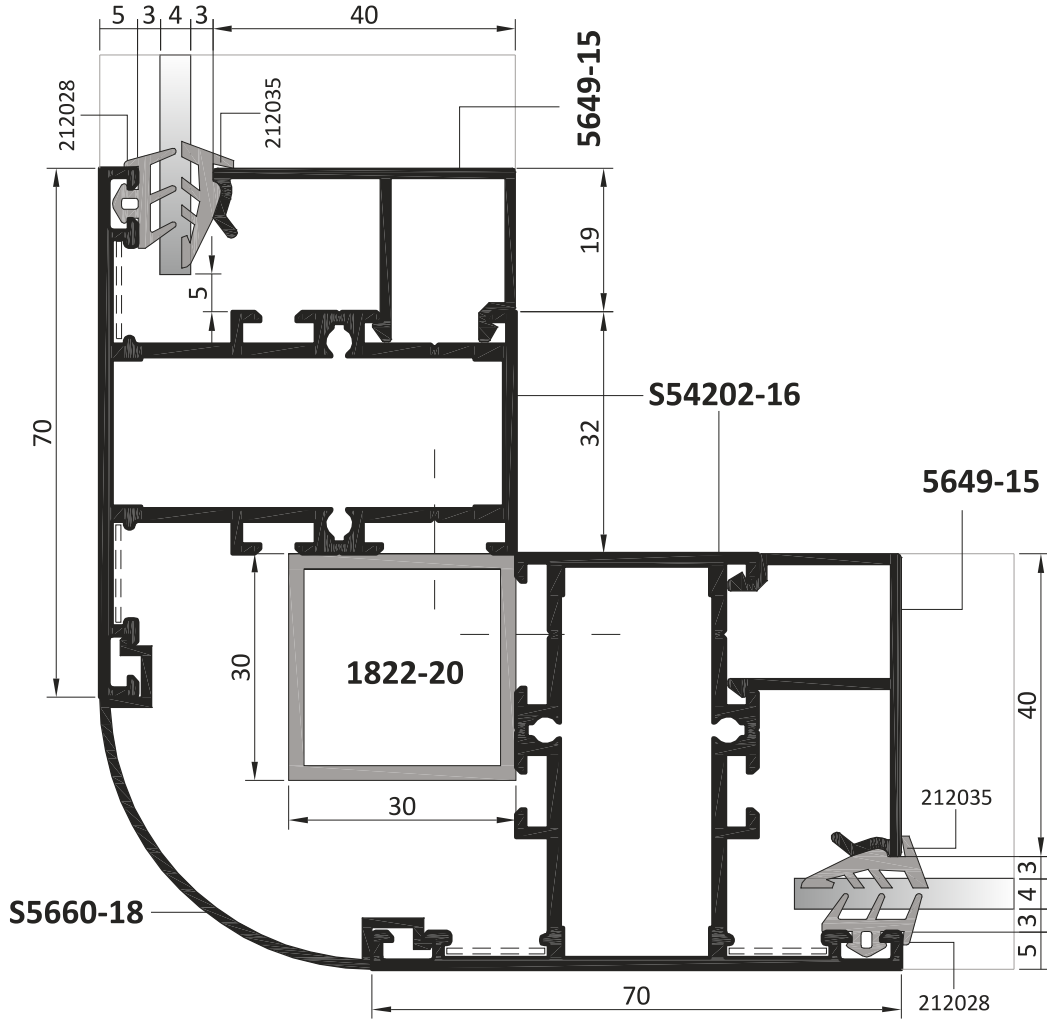
KÖŞE DÖNÜŞ DİLATASYON DETAYI
CORNER DILATATION DETAIL

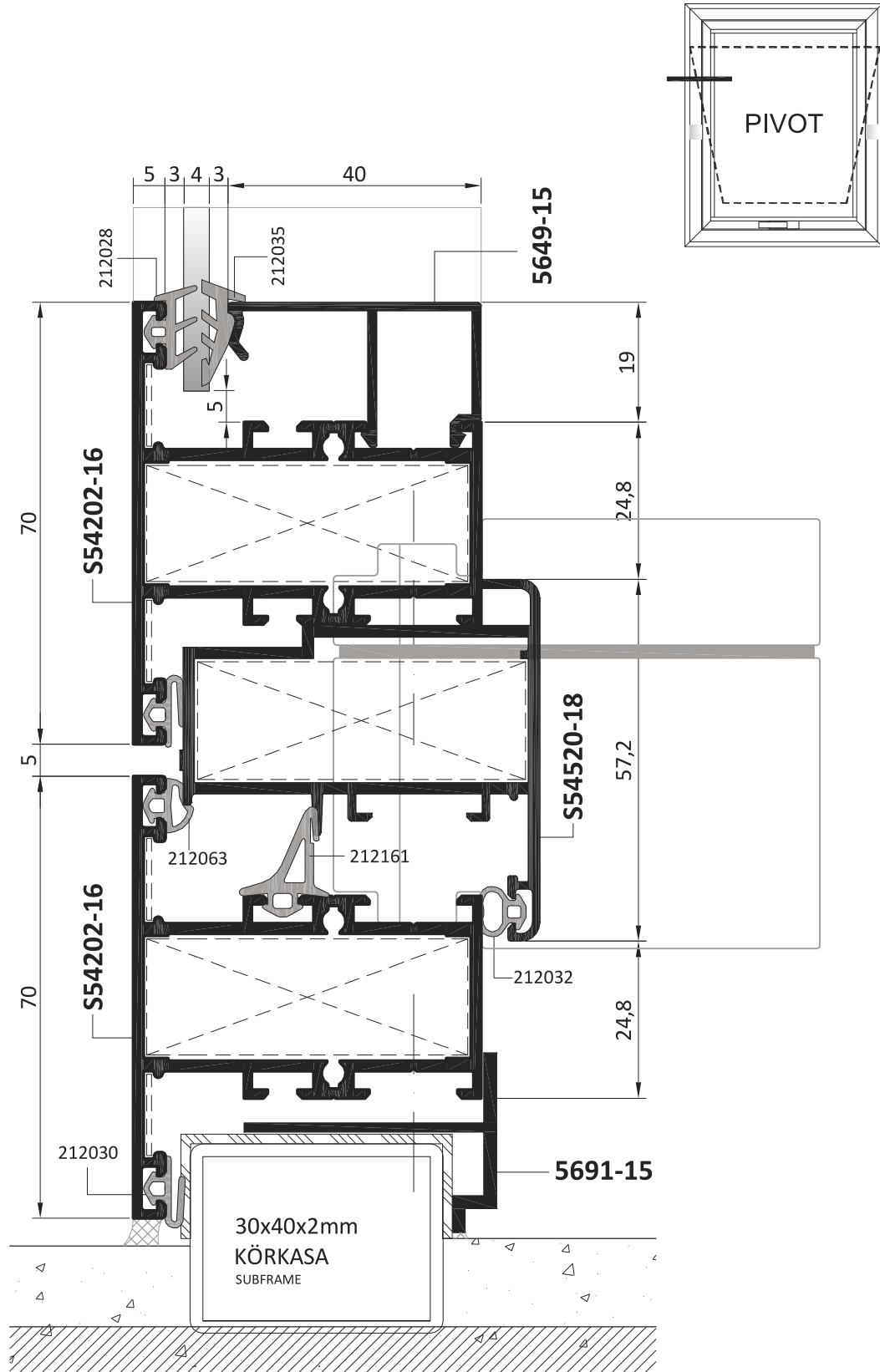

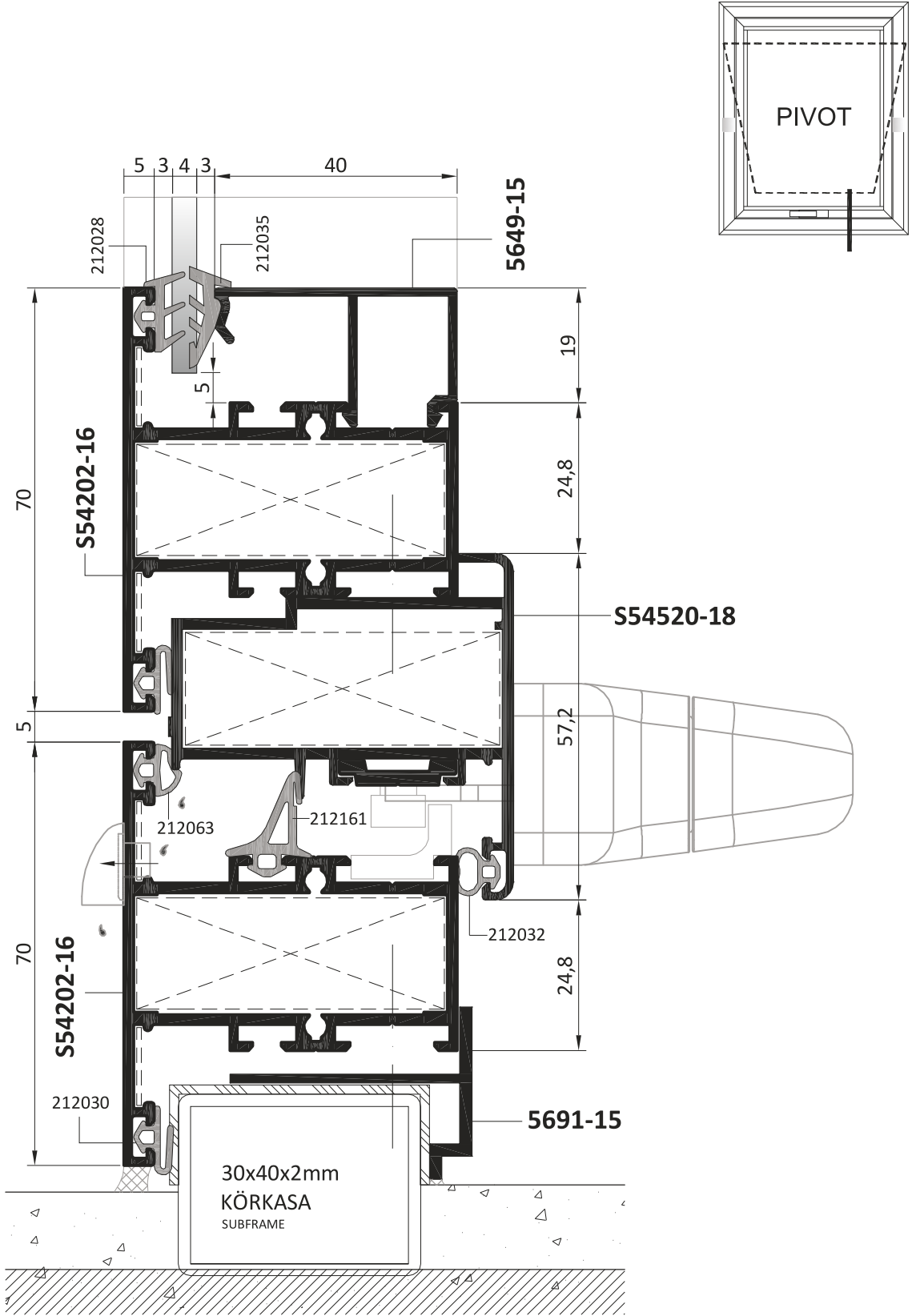

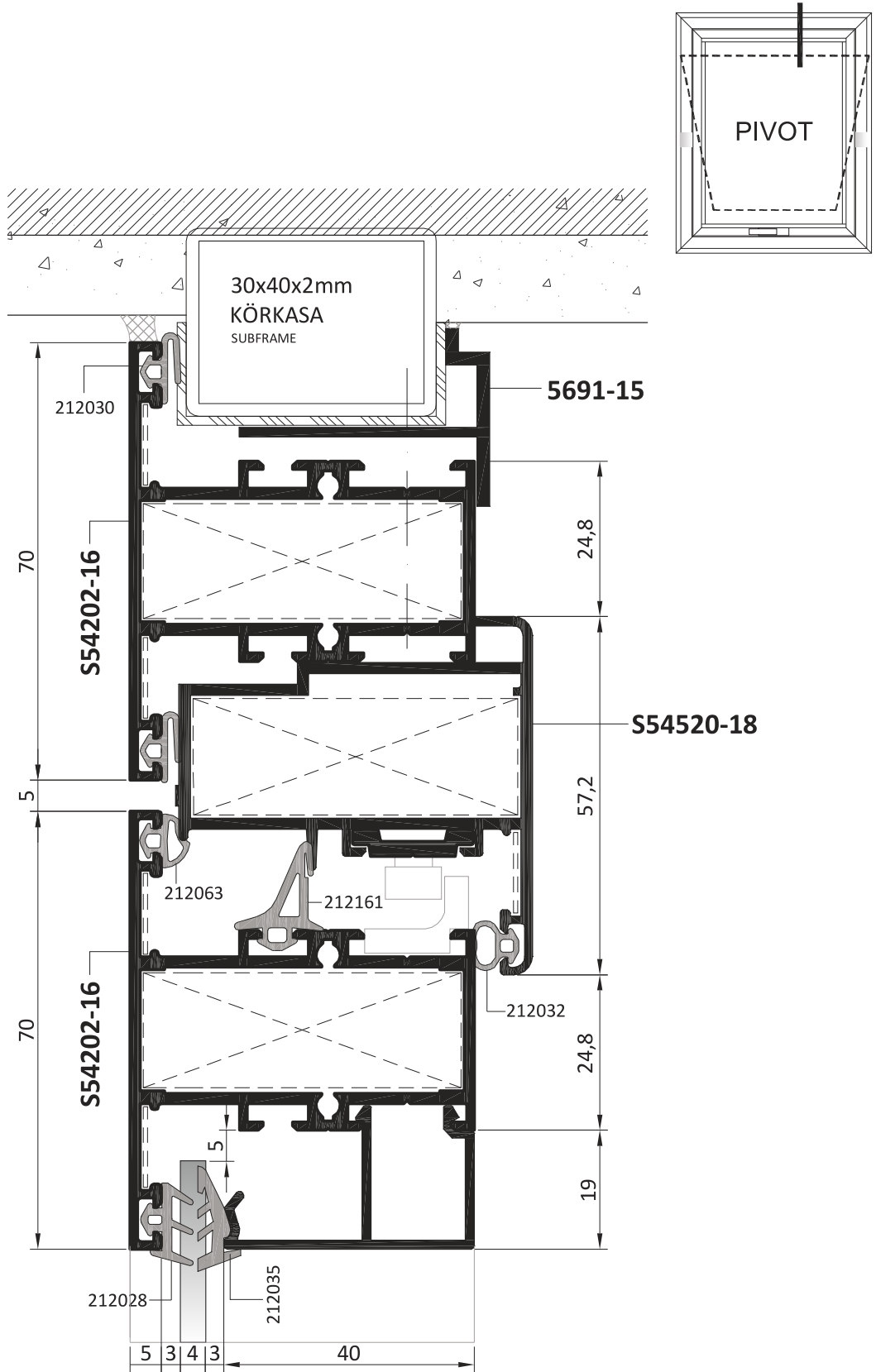

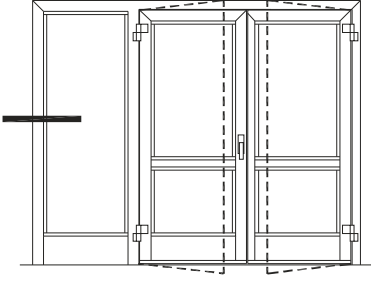
**İÇE AÇILIR BİNİLİ KAPI**

INWARD OPENING DOOR WITH STEP HINGE

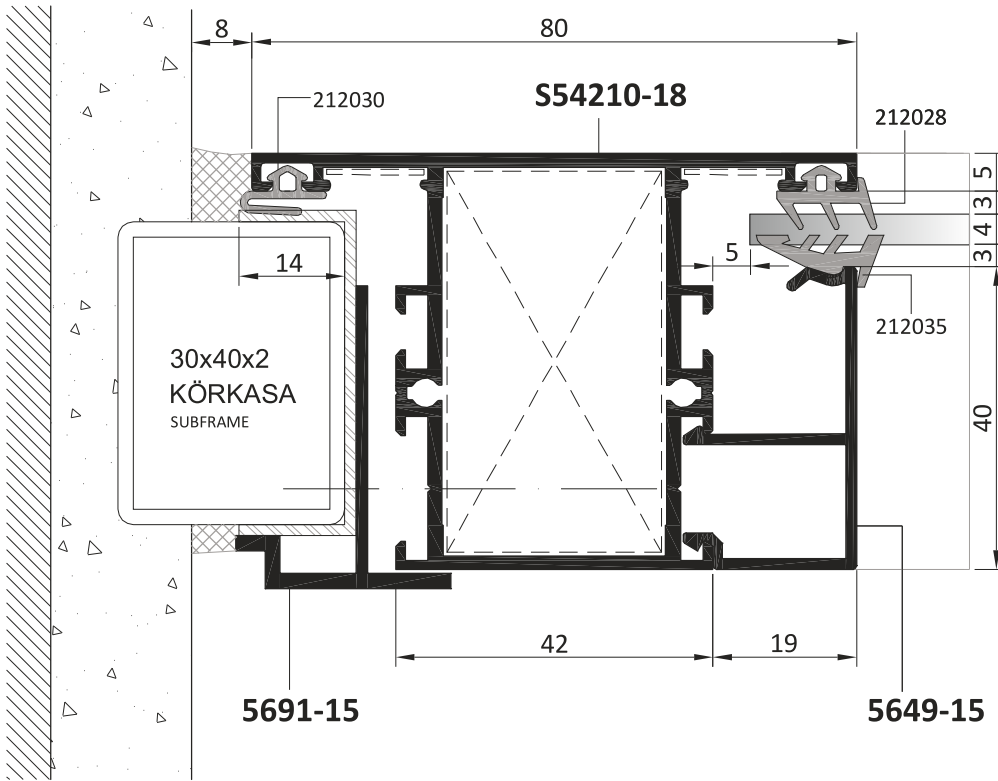
YALITIMSIZ SİSTEM DETAYLARI
UNINSULATED SYSTEM DETAILS

YALITIMSIZ SİSTEM DETAYLARI UNINSULATED SYSTEM DETAILS

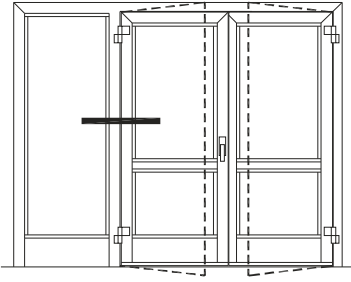

İÇE AÇILIR BİNİLİ KAPI
INWARD OPENING DOOR WITH STEP HINGE

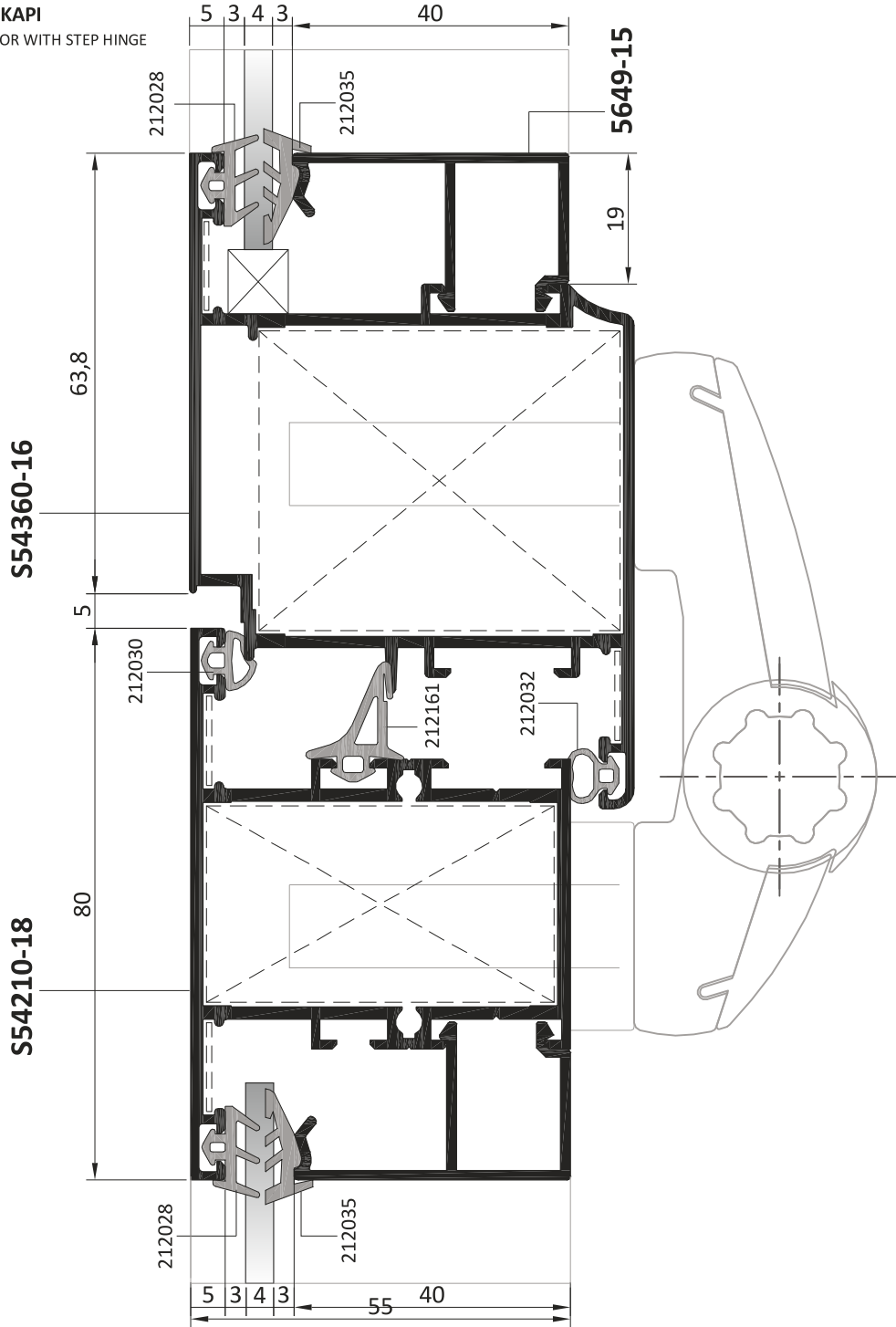

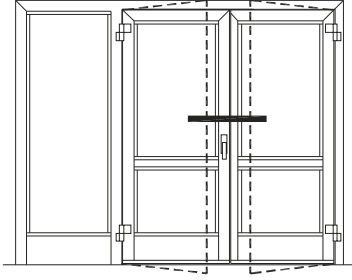

İÇE AÇILIR BİNİLİ KAPI
INWARD OPENING DOOR WITH STEP HINGE

YALITIMSIZ SİSTEM DETAYLARI
UNINSULATED SYSTEM DETAILS

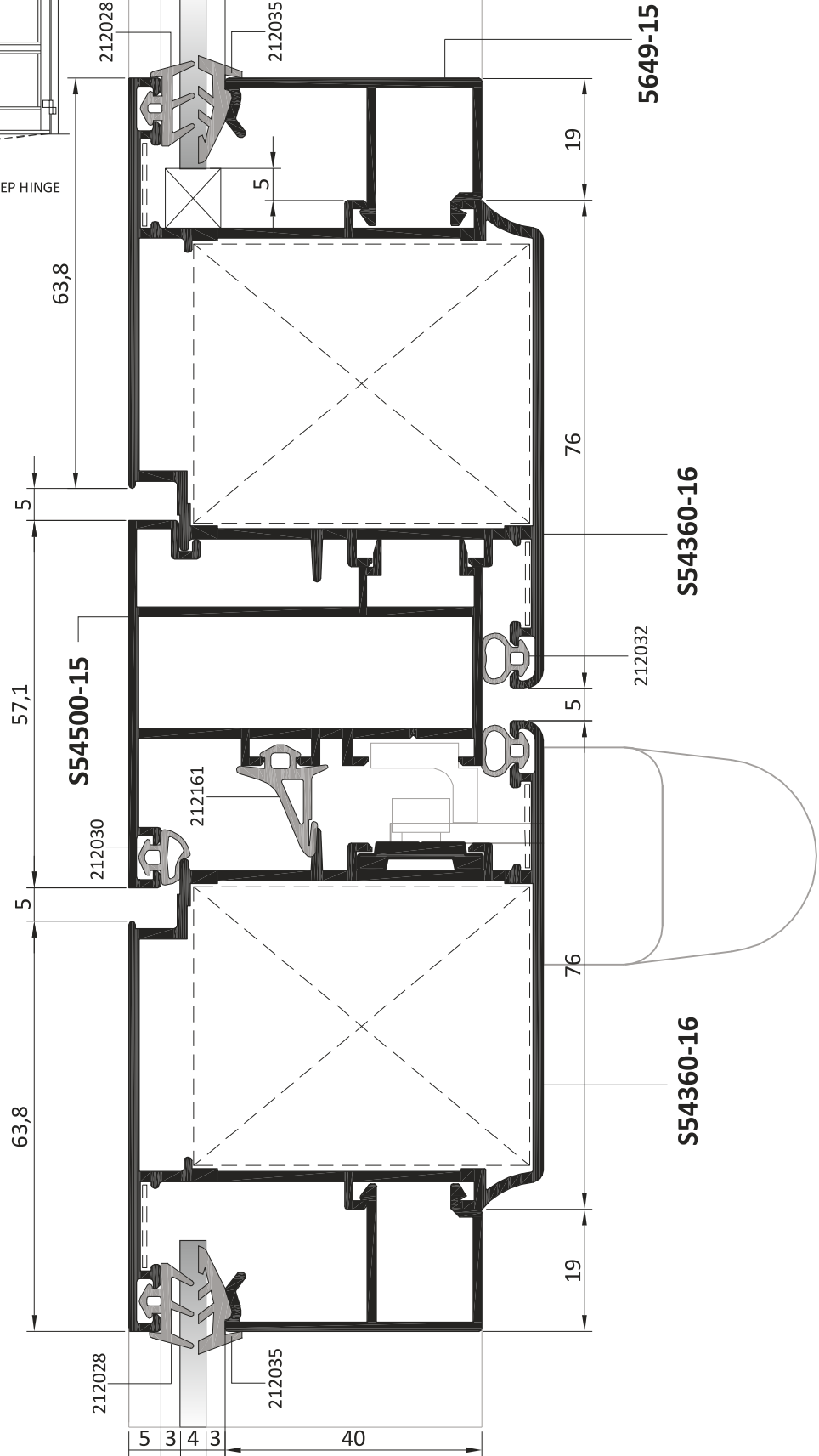

YALITIMSIZ SİSTEM DETAYLARI UNINSULATED SYSTEM DETAILS

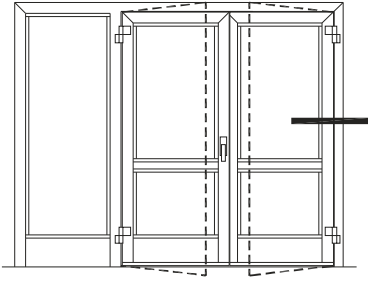

İÇE AÇILIR BİNİLİ KAPI
INWARD OPENING DOOR WITH STEP HINGE

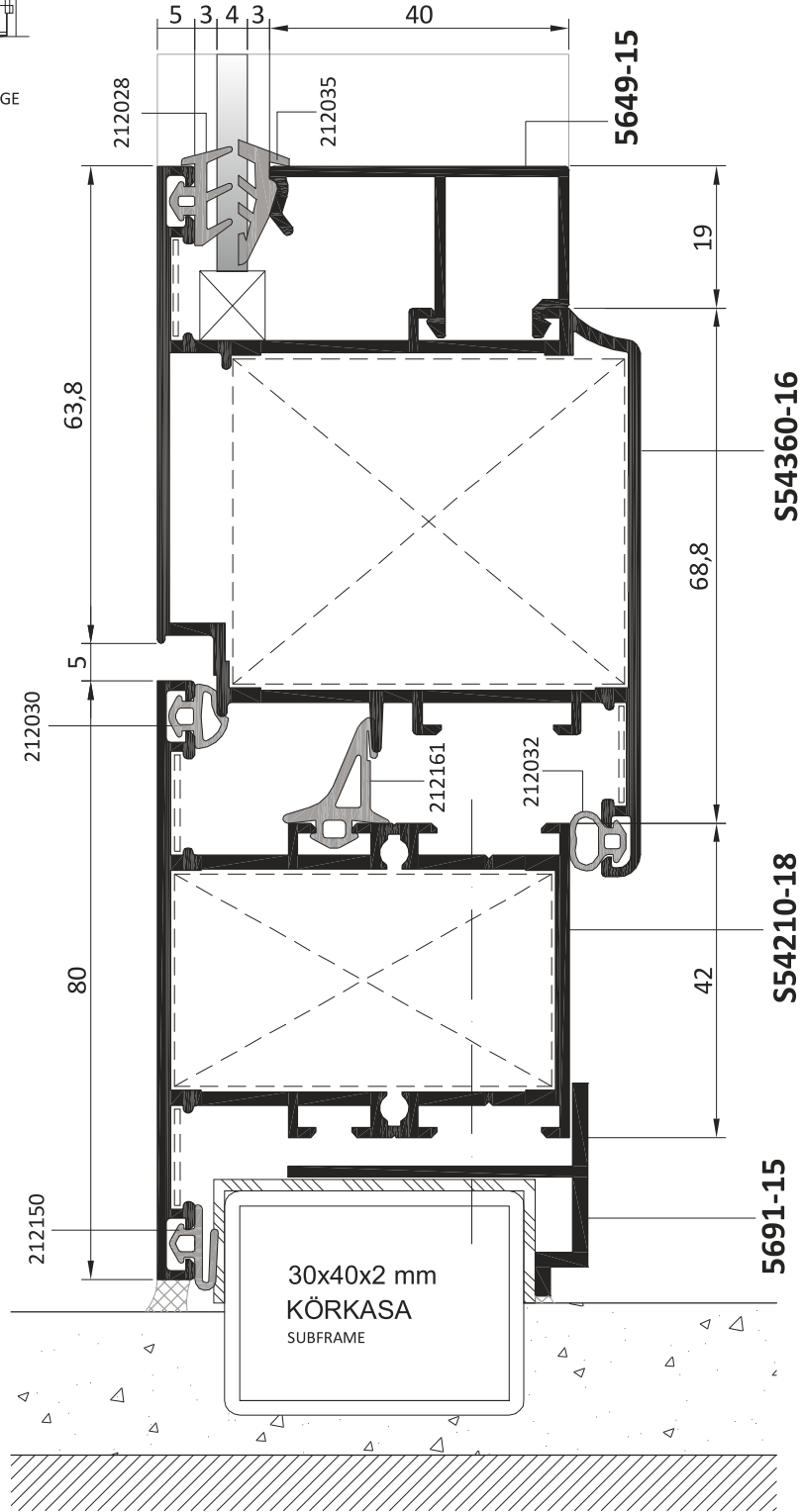

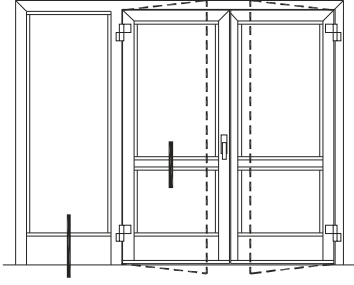
**İÇE AÇILIR BİNİLİ KAPI**

INWARD OPENING DOOR WITH STEP HINGE

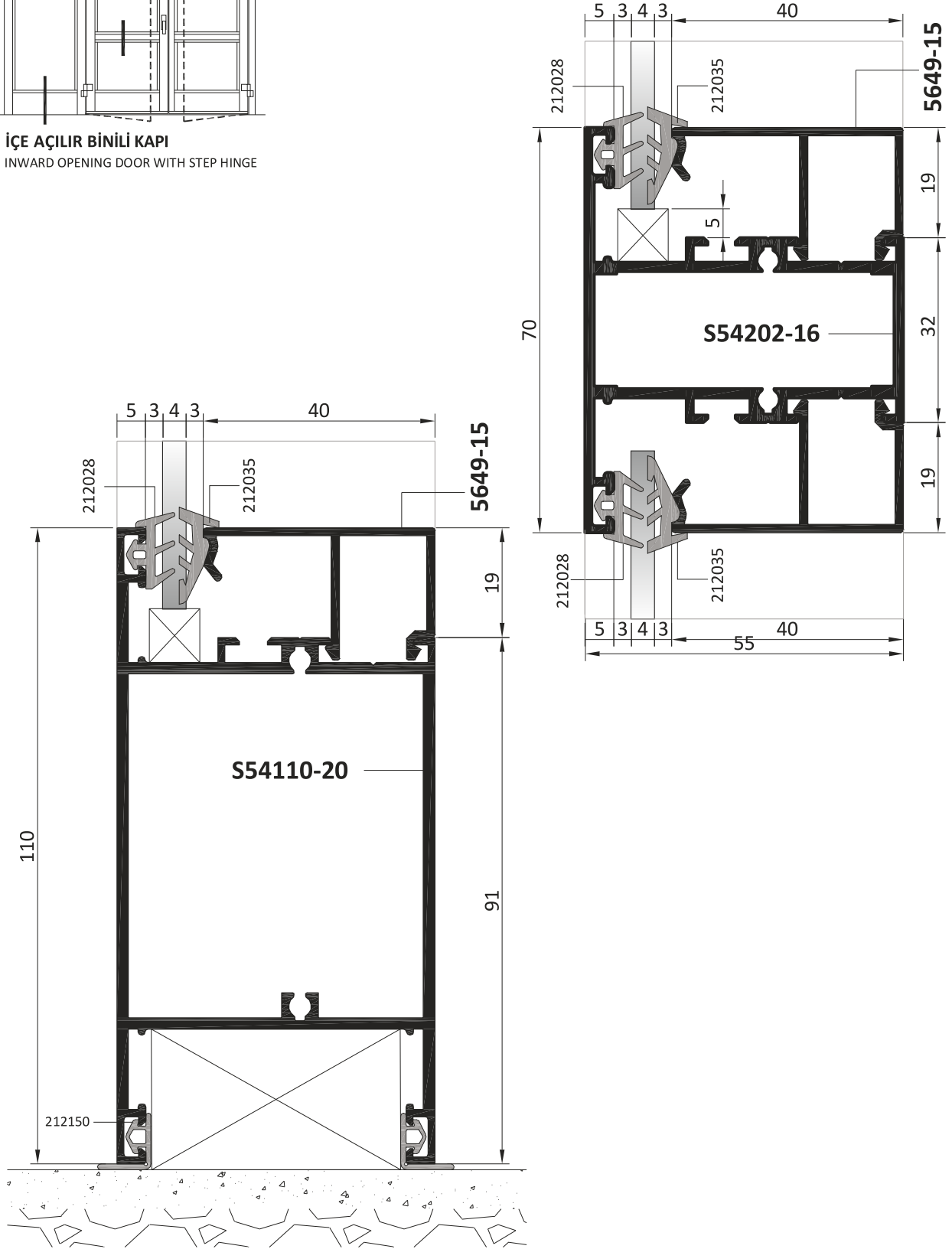
YALITIMSIZ SİSTEM DETAYLARI
UNINSULATED SYSTEM DETAILS

120

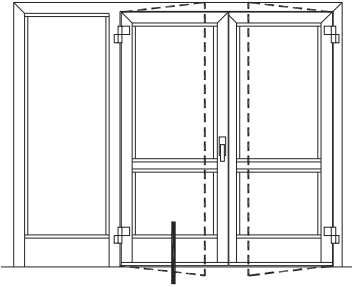
**İÇE AÇILIR BİNİLİ KAPI**

INWARD OPENING DOOR WITH STEP HINGE

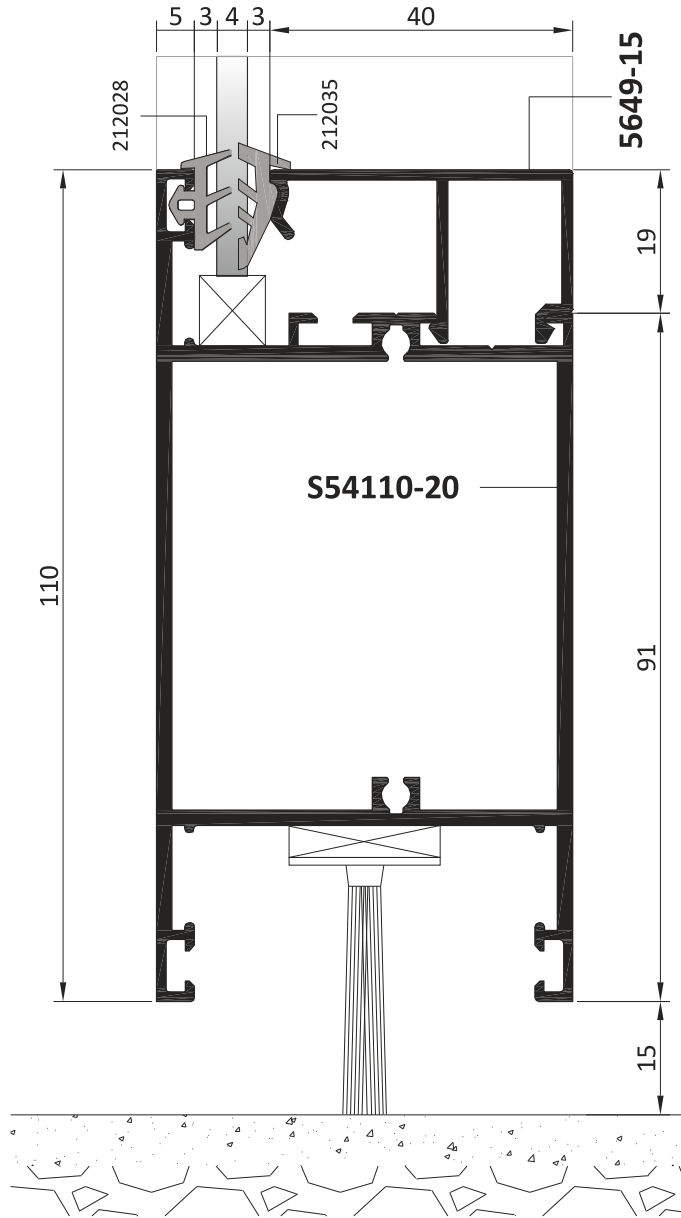
YALITIMSIZ SİSTEM DETAYLARI
UNINSULATED SYSTEM DETAILS

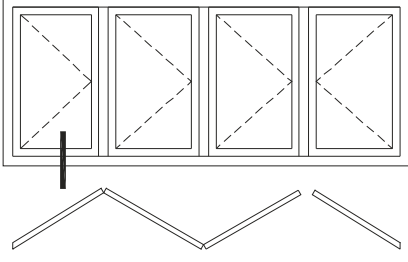
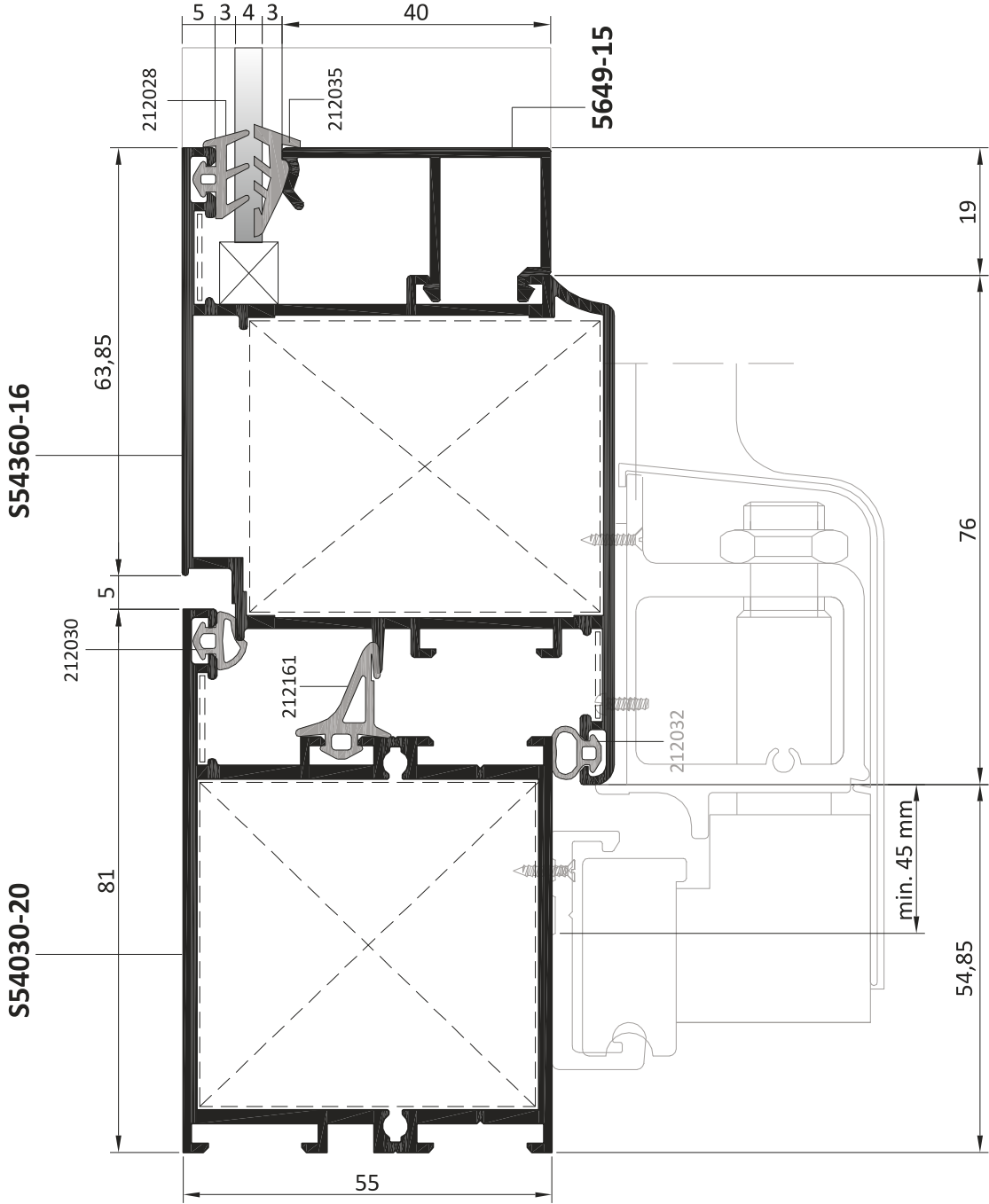
YALITIMSIZ SİSTEM DETAYLARI
UNINSULATED SYSTEM DETAILS**KATLANIR KAPI**
FOLDING DOOR

YALITIMSIZ SİSTEM DETAYLARI

UNINSULATED SYSTEM DETAILS

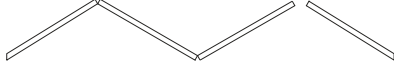
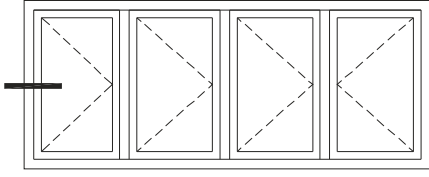

KATLANIR KAPI
FOLDING DOOR

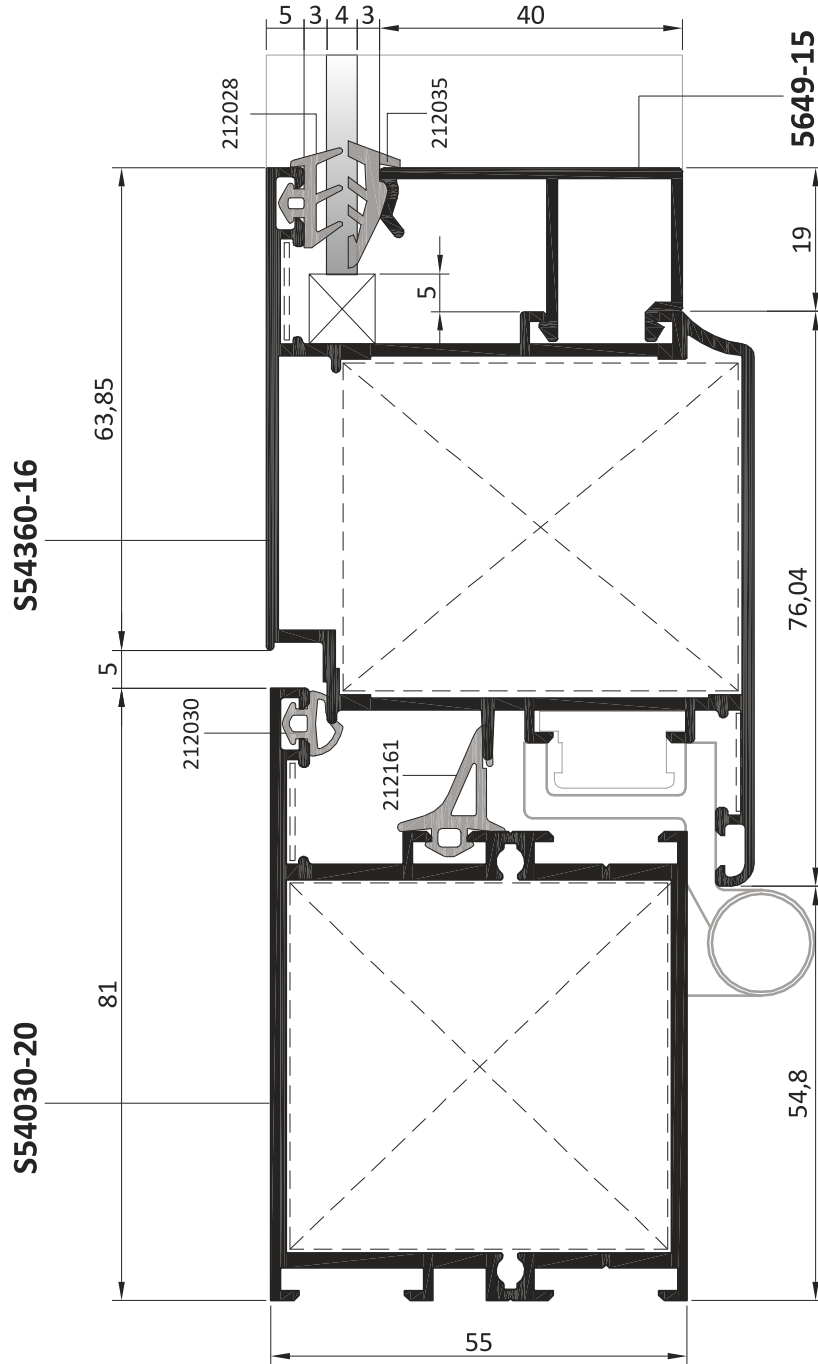

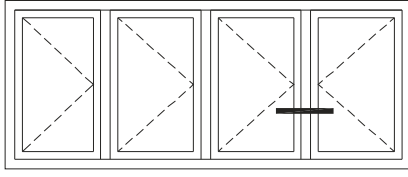

KATLANIR KAPI
FOLDING DOOR

YALITIMSIZ SİSTEM DETAYLARI
UNINSULATED SYSTEM DETAILS

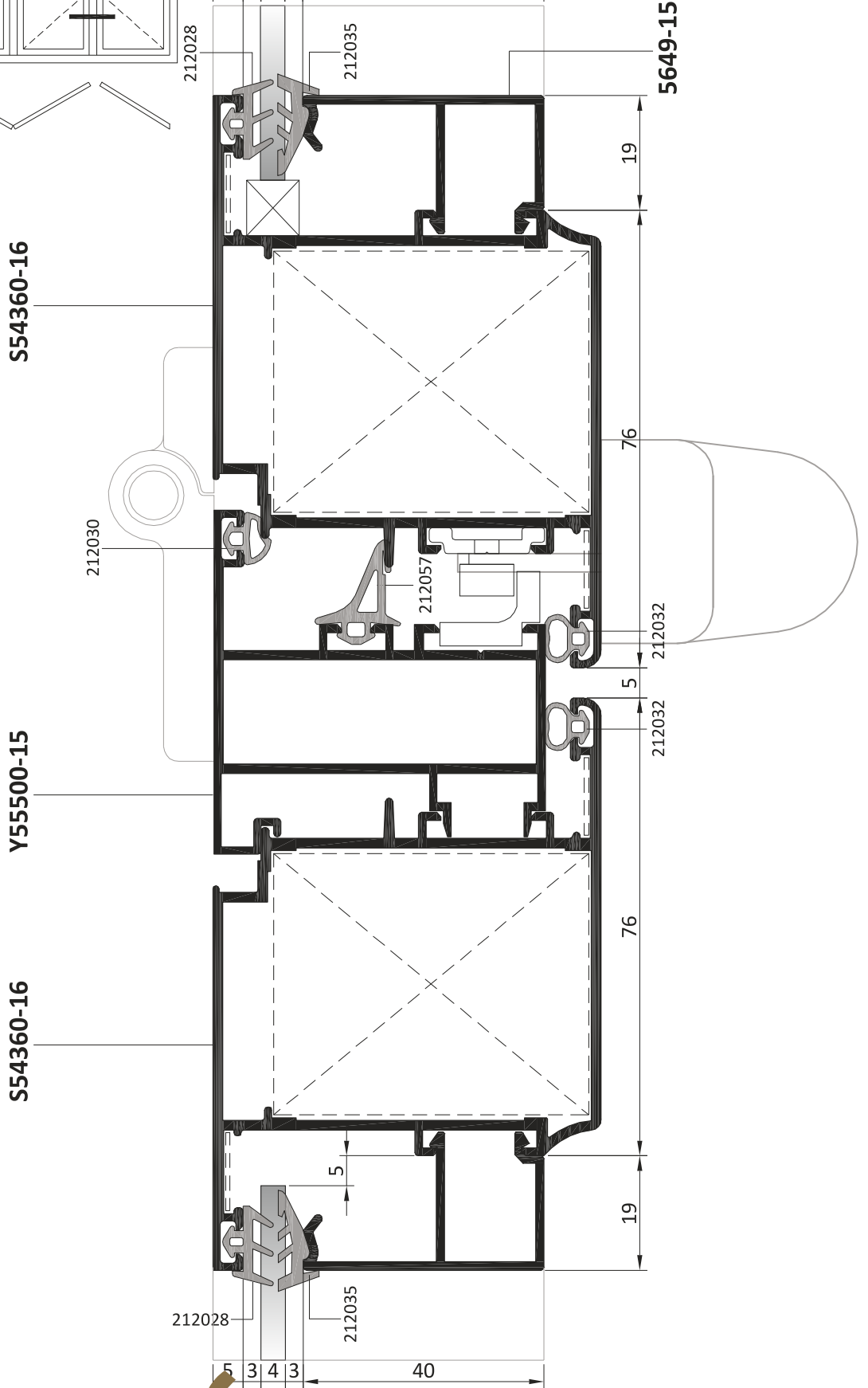

S54360-16

Y55500-15

S54360-16

YALITIMSIZ SİSTEM DETAYLARI UNINSULATED SYSTEM DETAILS

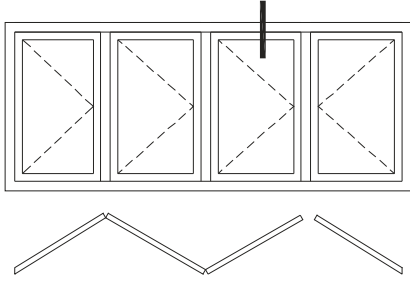

KATLANIR KAPI
FOLDING DOOR

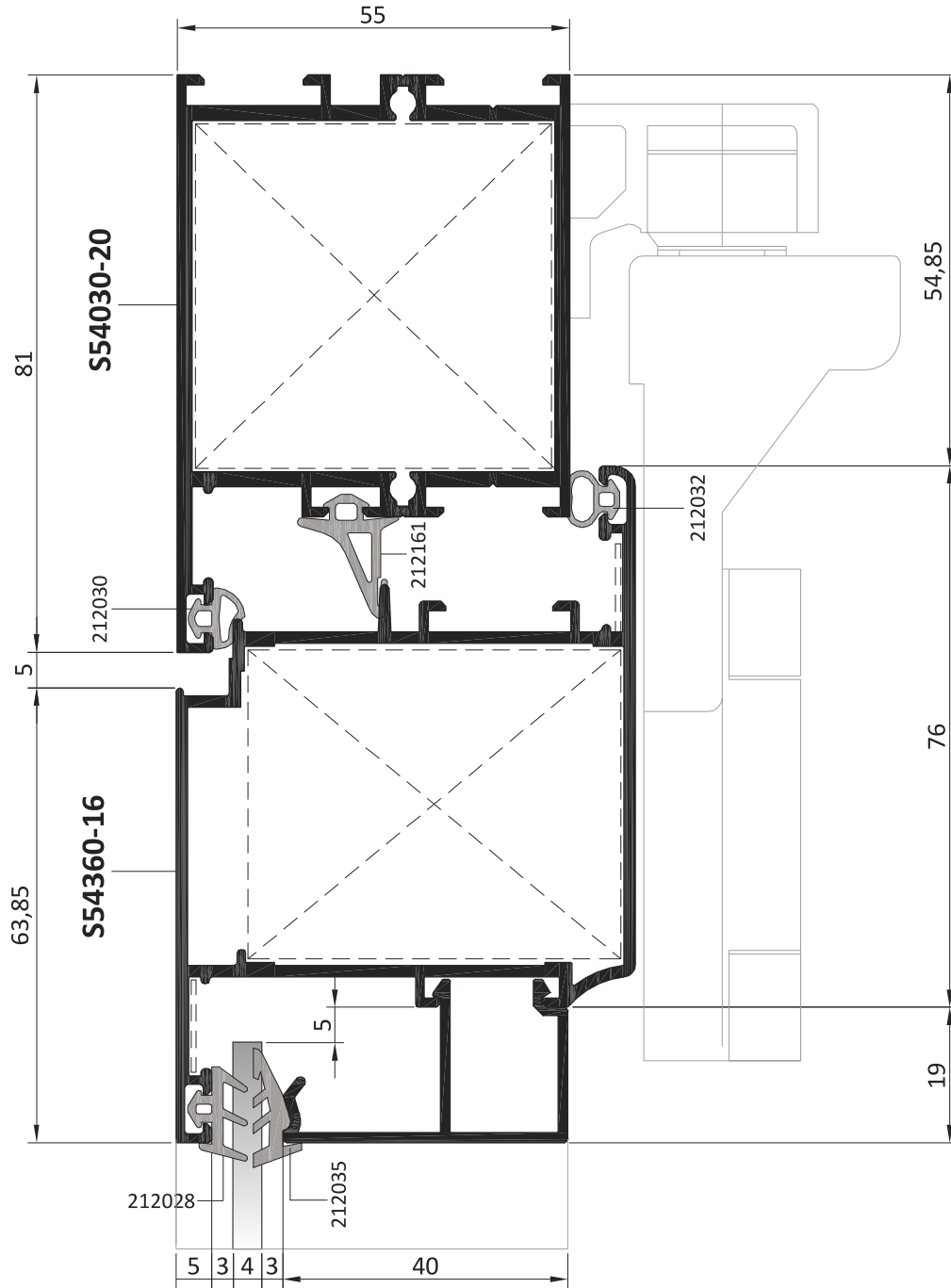

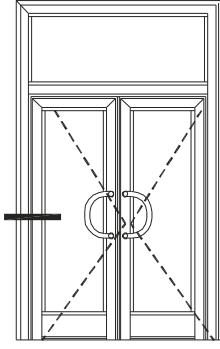

ÇARPMA KAPI
SWING DOOR

YALITIMSIZ SİSTEM DETAYLARI
UNINSULATED SYSTEM DETAILS

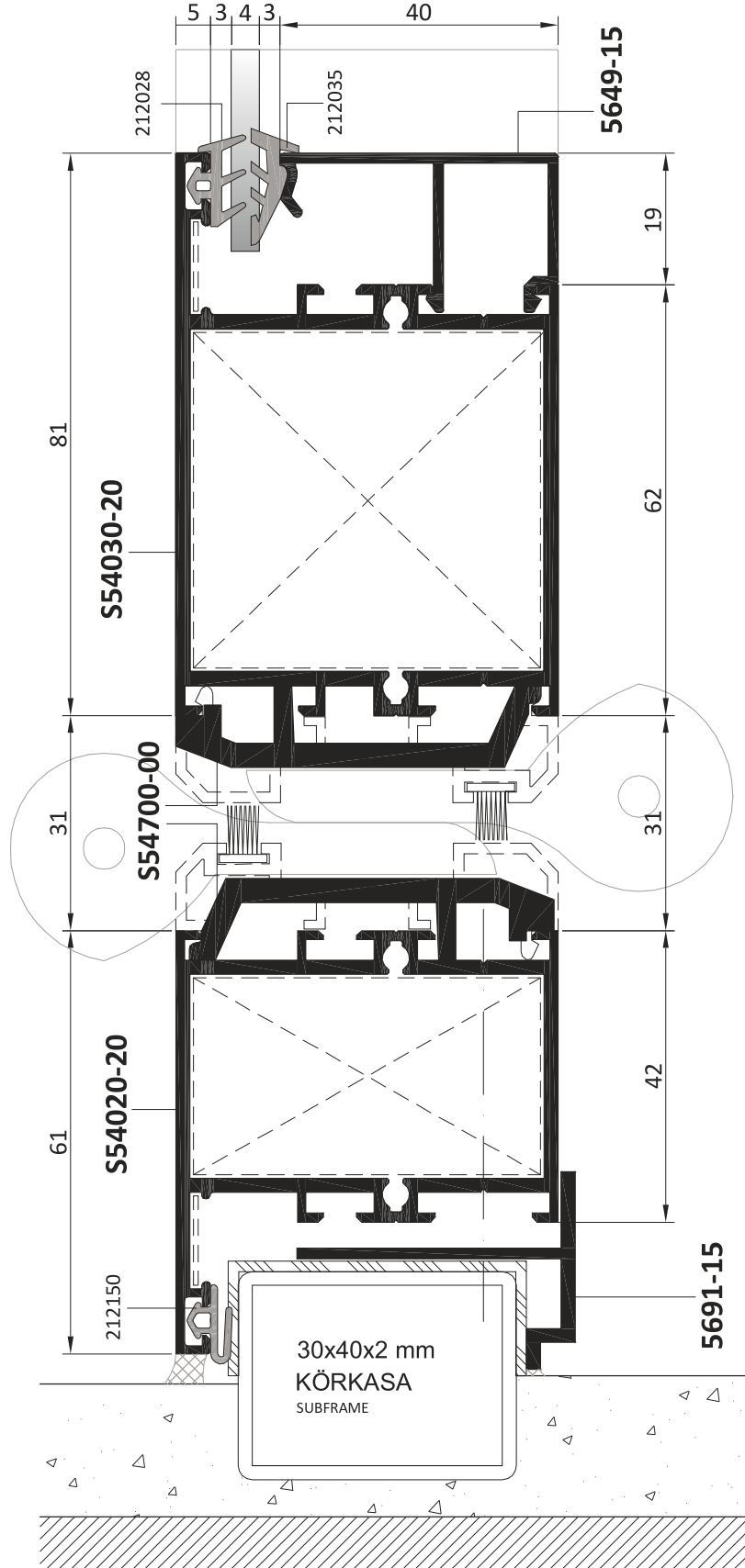

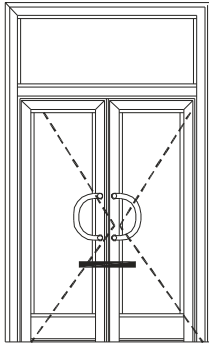

ÇARPMA KAPI
SWING DOOR

YALITIMSIZ SİSTEM DETAYLARI UNINSULATED SYSTEM DETAILS

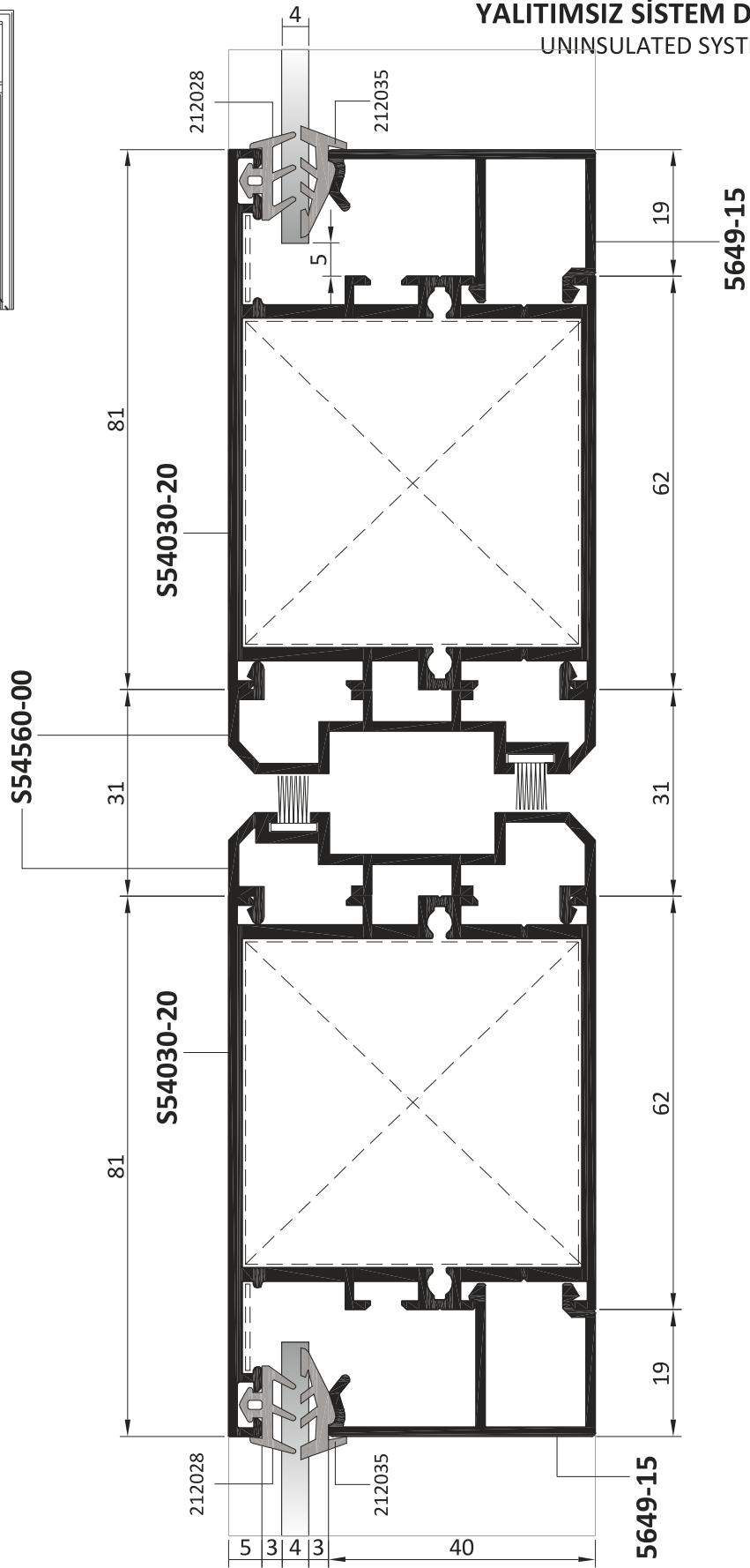

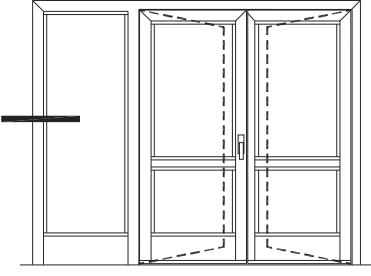
YALITIMSIZ SİSTEM DETAYLARI
UNINSULATED SYSTEM DETAILS

DIŞA AÇILIR BİNİLİ KAPI
OUTWARD OPENING DOOR WITH STEP HINGE

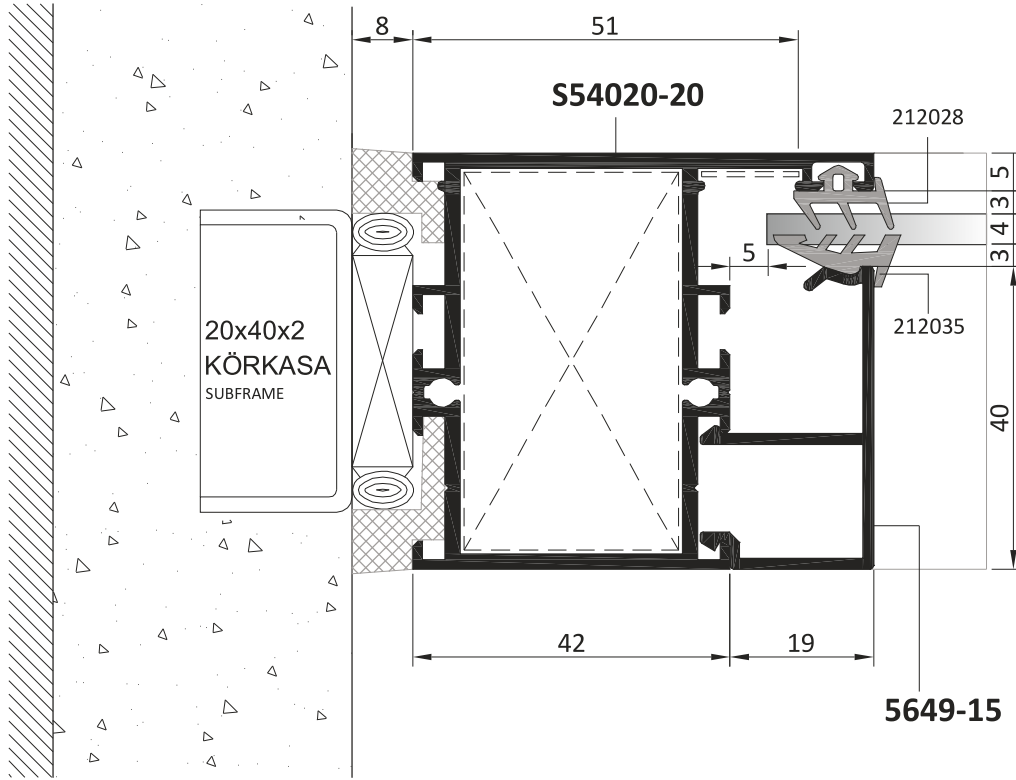

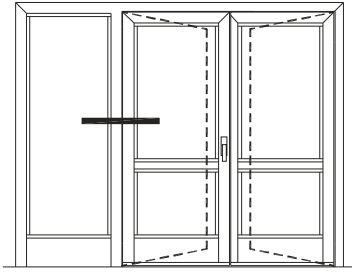

DIŐA AÇILIR BİNİLİ KAPI
OUTWARD OPENING DOOR WITH STEP HINGE

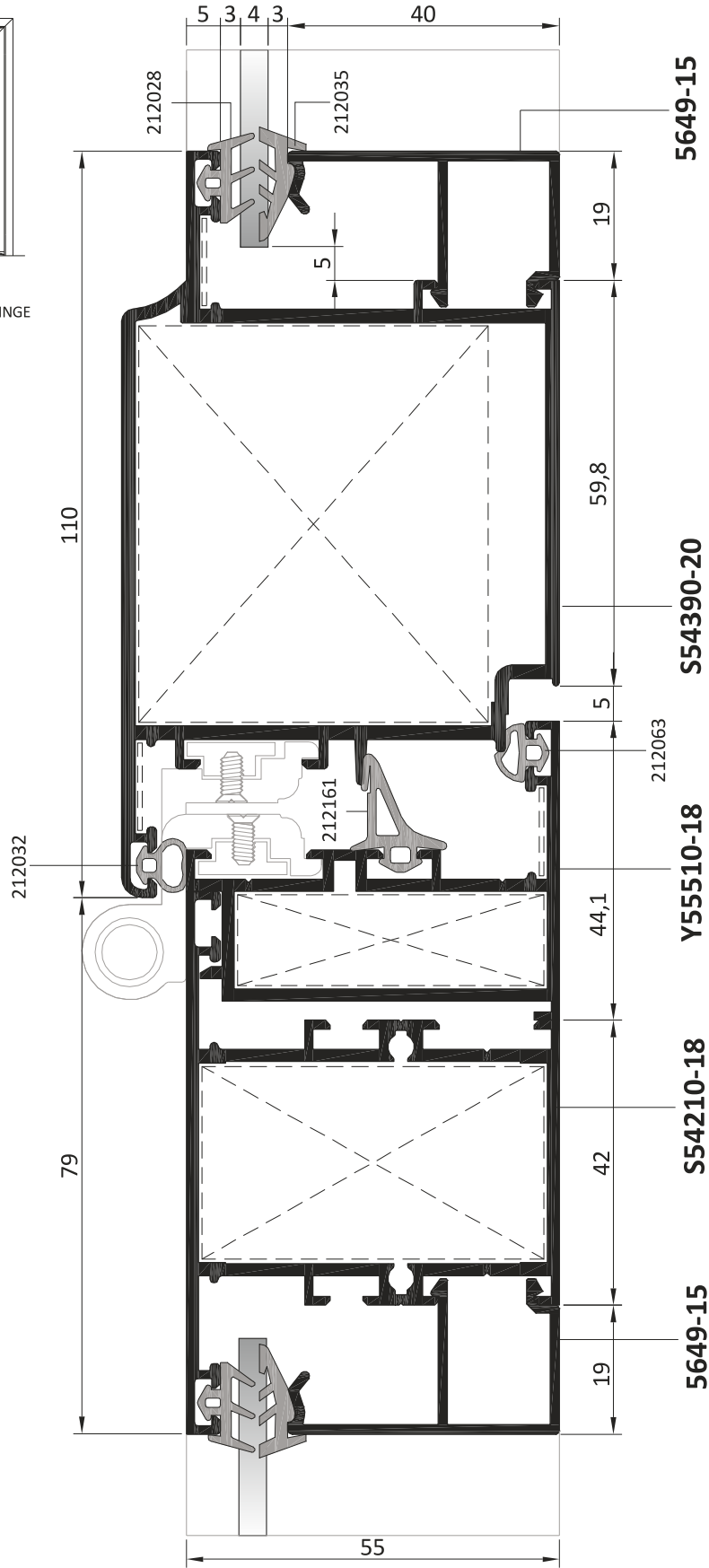

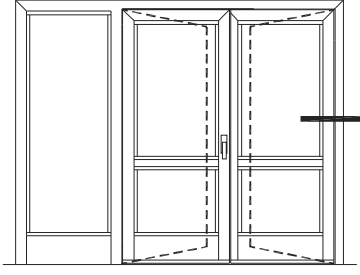

DIŐA AÇILIR BİNİLİ KAPI
OUTWARD OPENING DOOR WITH STEP HINGE

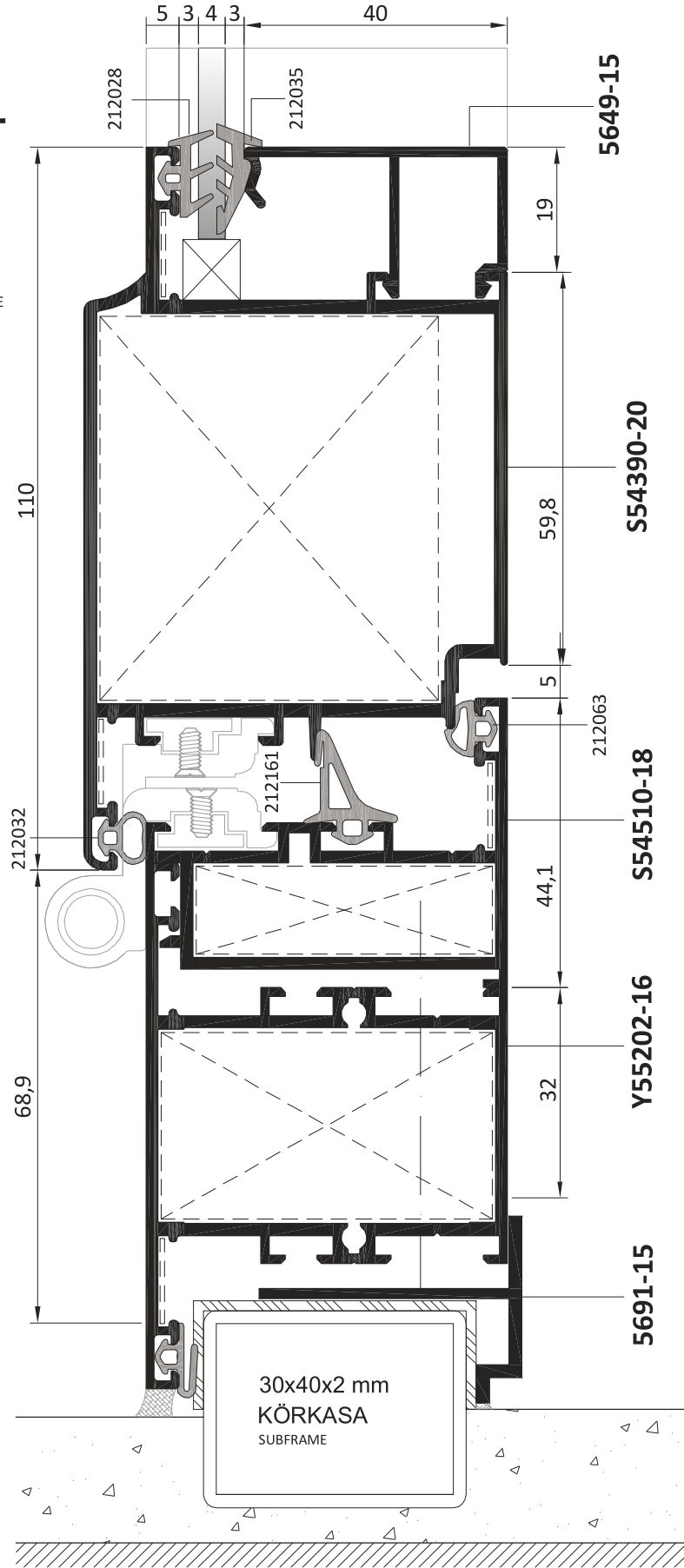

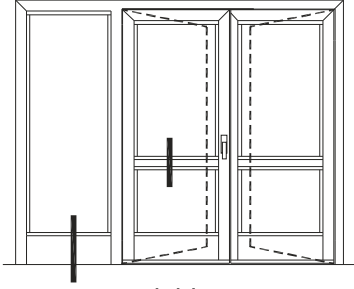

DIŐA AÇILIR BİNİLİ KAPI
OUTWARD OPENING DOOR WITH STEP HINGE

YALITIMSIZ SİSTEM DETAYLARI
UNINSULATED SYSTEM DETAILS

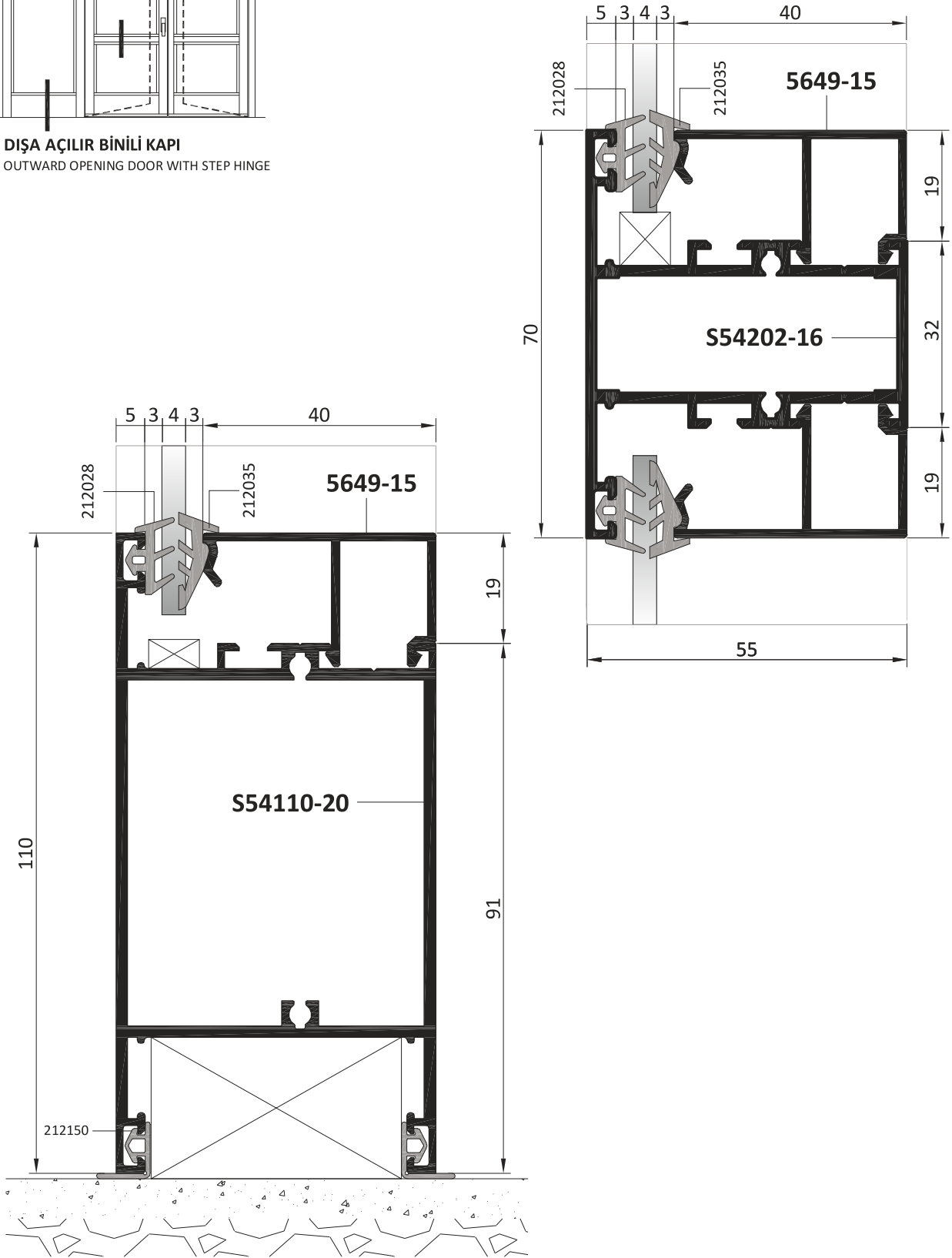

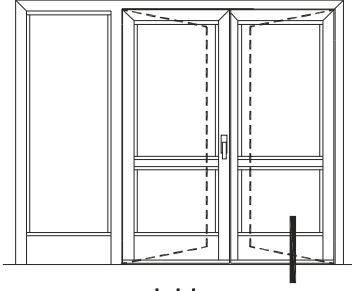

DIŐA AÇILIR BİNİLİ KAPI

OUTWARD OPENING DOOR WITH STEP HINGE

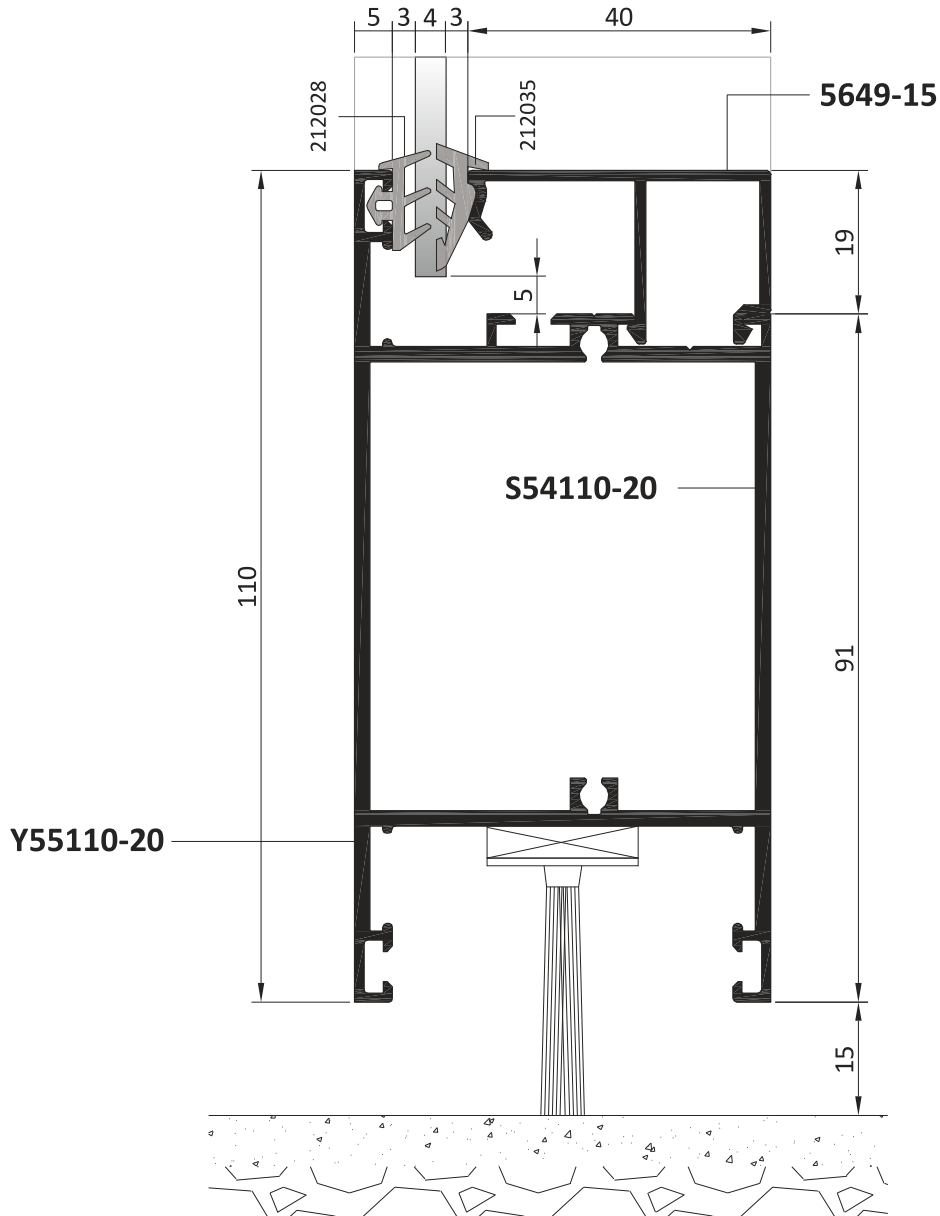
YALITIMSIZ SİSTEM DETAYLARI
UNINSULATED SYSTEM DETAILS

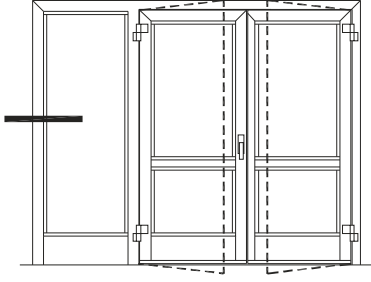

İÇE AÇILIR HEMYÜZ KAPI
INWARD OPENING FLUSH DOOR

YALITIMSIZ SİSTEM DETAYLARI
UNINSULATED SYSTEM DETAILS

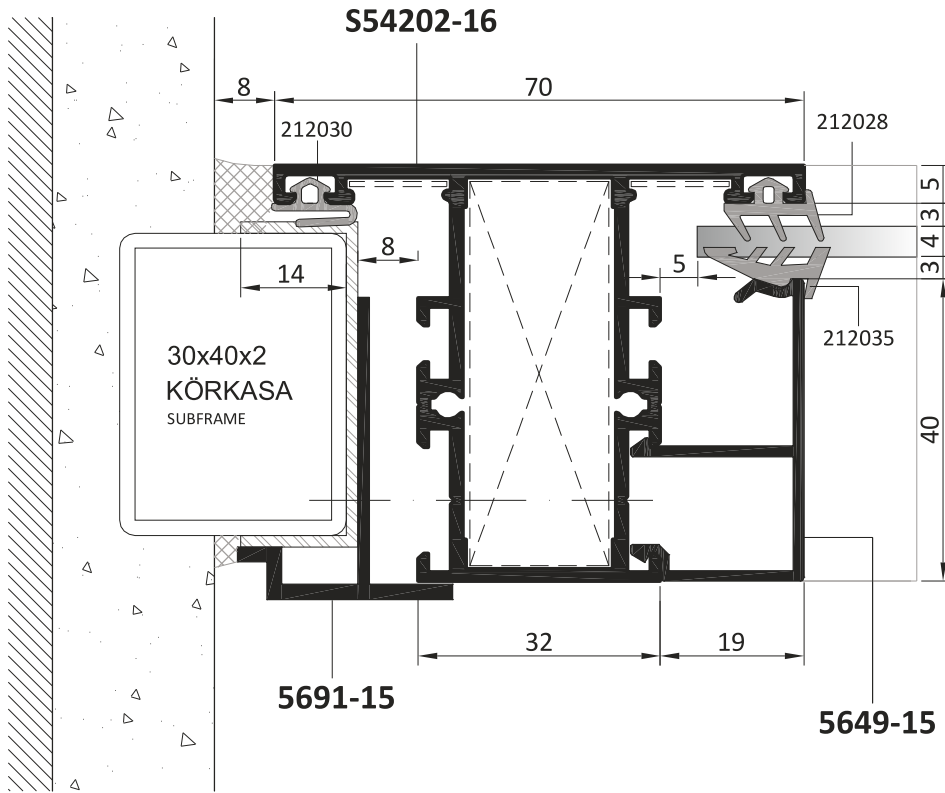

YALITIMSIZ SİSTEM DETAYLARI UNINSULATED SYSTEM DETAILS

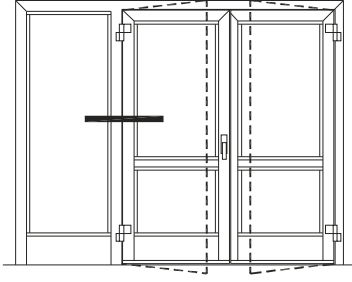

İÇE AÇILIR HEMYÜZ KAPI
INWARD OPENING FLUSH DOOR

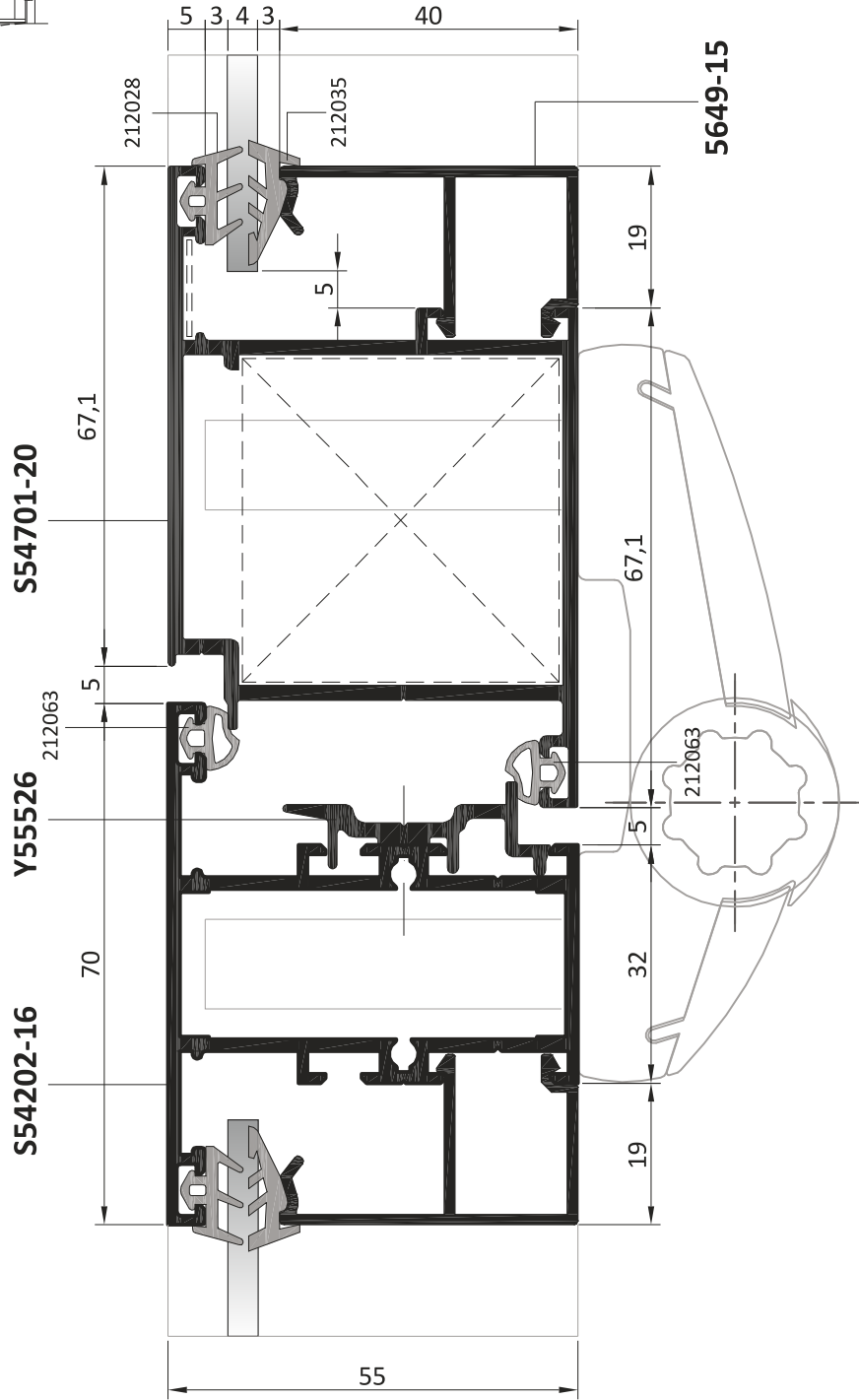

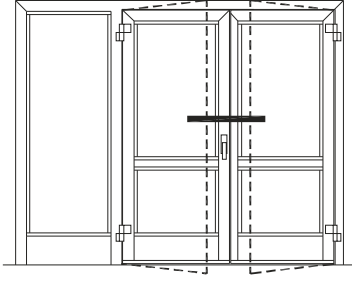

İÇE AÇILIR HEMYÜZ KAPI
INWARD OPENING FLUSH DOOR

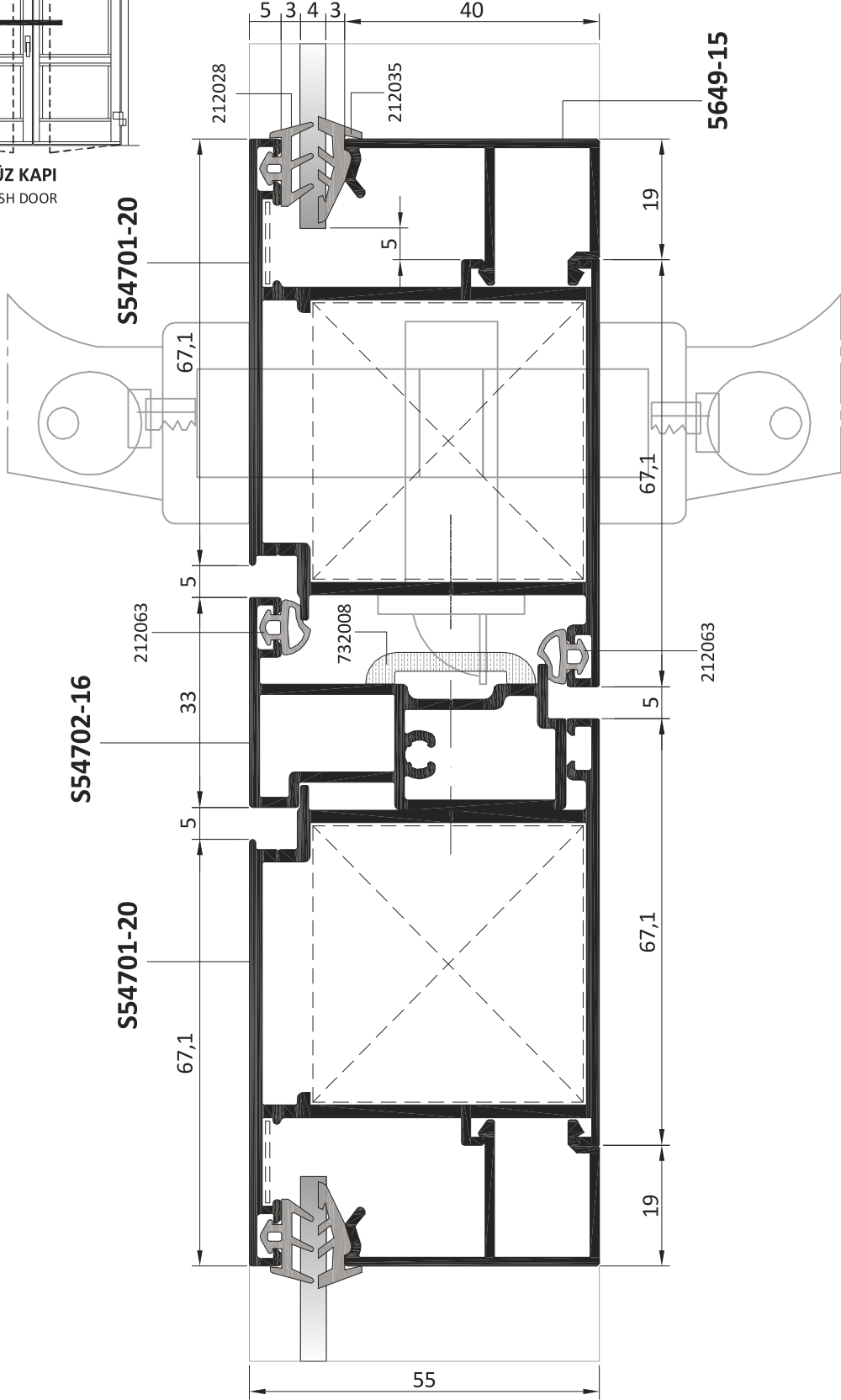

YALITIMSIZ SİSTEM DETAYLARI UNINSULATED SYSTEM DETAILS

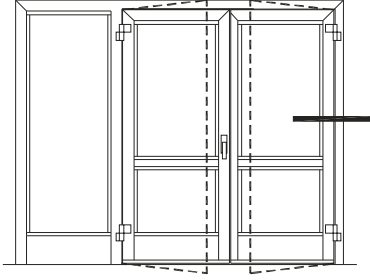

İÇE AÇILIR HEMYÜZ KAPI
INWARD OPENING FLUSH DOOR

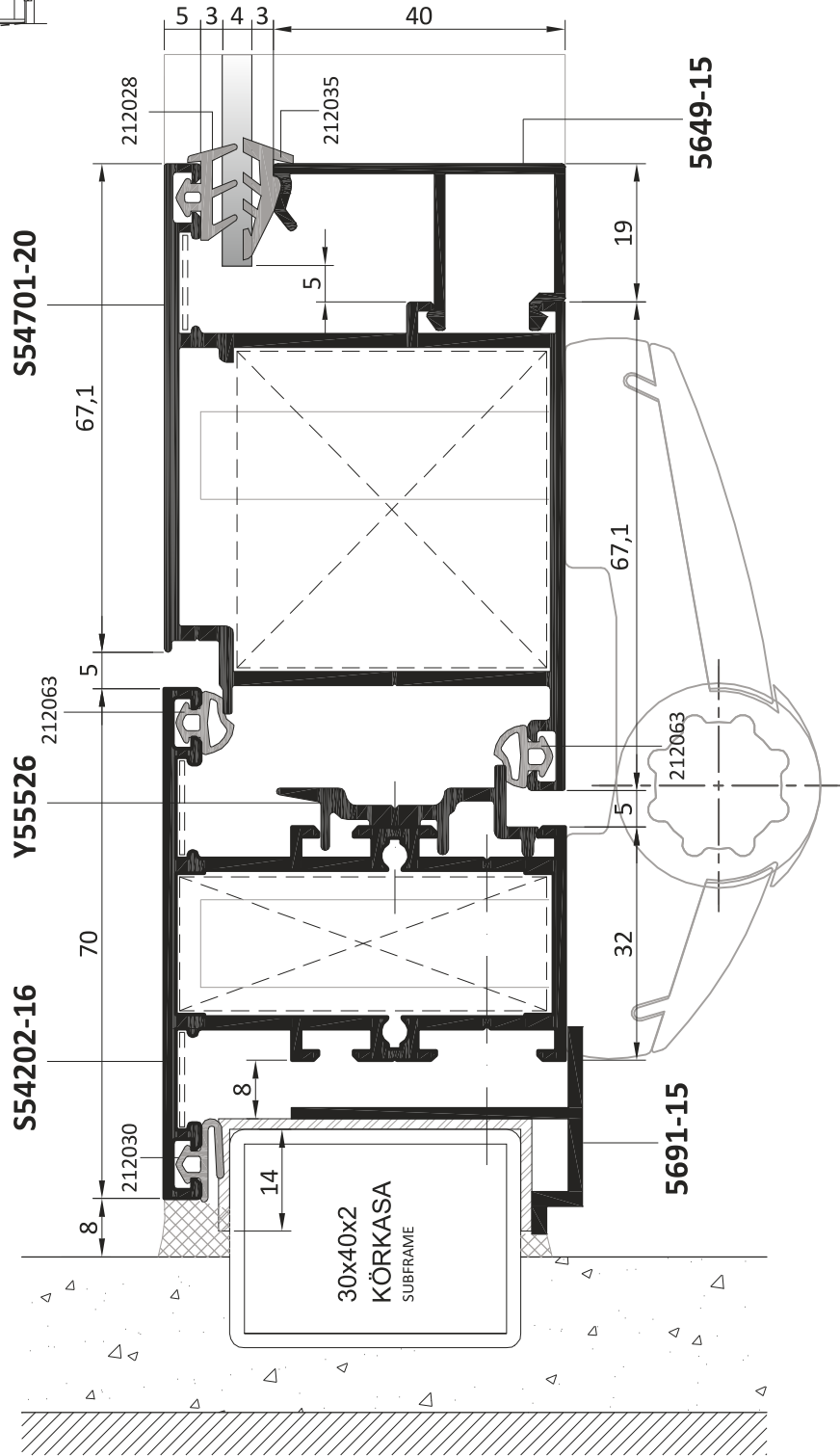

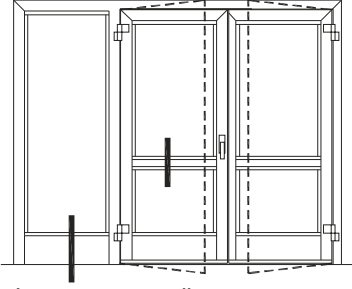

İÇE AÇILIR HEMYÜZ KAPI
INWARD OPENING FLUSH DOOR

YALITIMSIZ SİSTEM DETAYLARI
UNINSULATED SYSTEM DETAILS

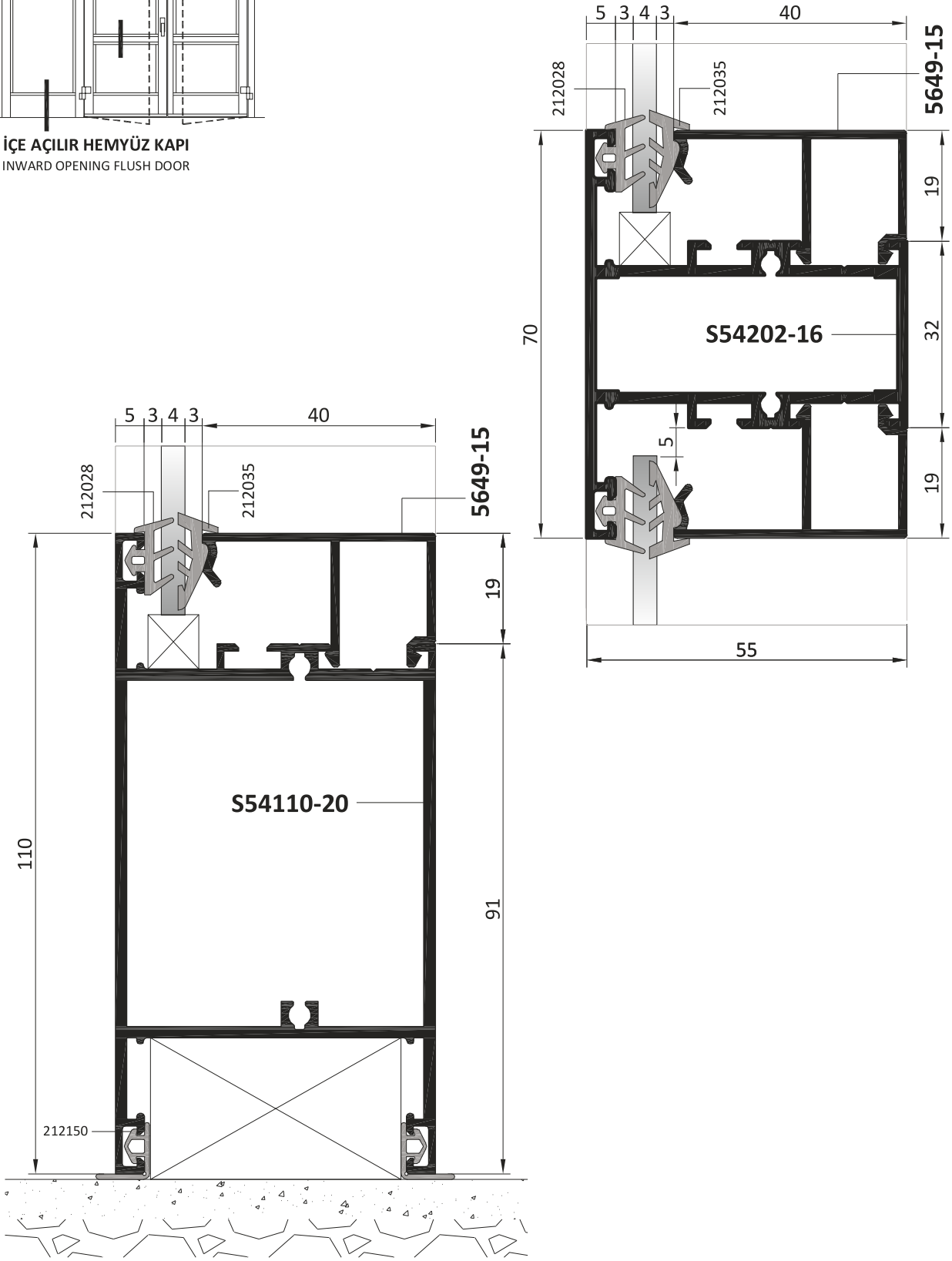

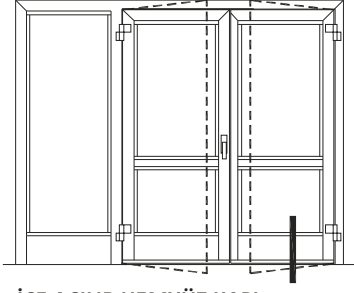

İÇE AÇILIR HEMYÜZ KAPI
INWARD OPENING FLUSH DOOR

YALITIMSIZ SİSTEM DETAYLARI UNINSULATED SYSTEM DETAILS

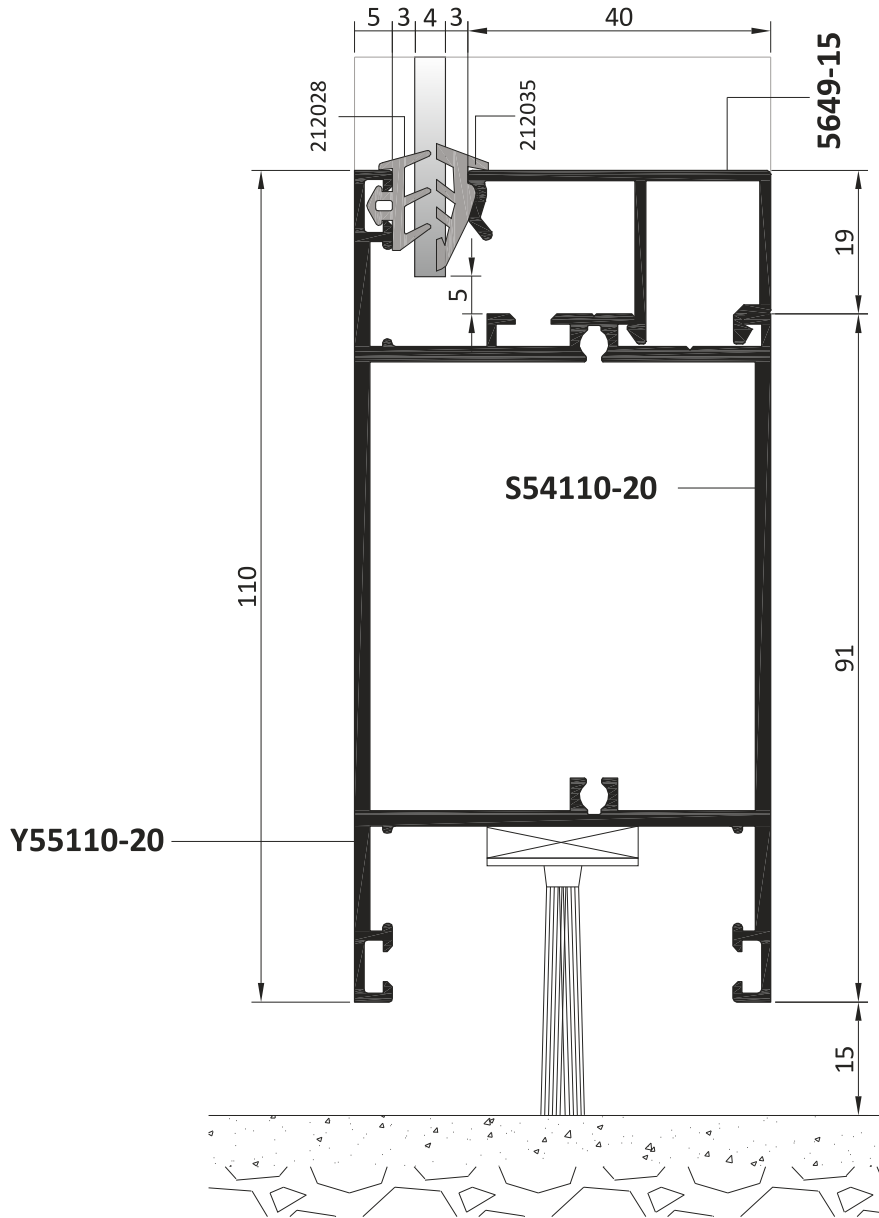

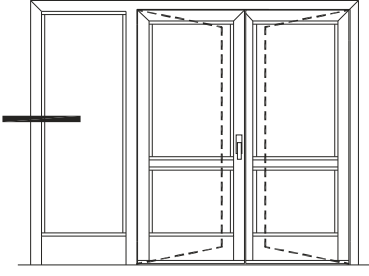

DIŐA AÇILIR HEMYÖZ KAPI
OUTWARD OPENING FLUSH DOOR

YALITIMSIZ SİSTEM DETAYLARI
UNINSULATED SYSTEM DETAILS

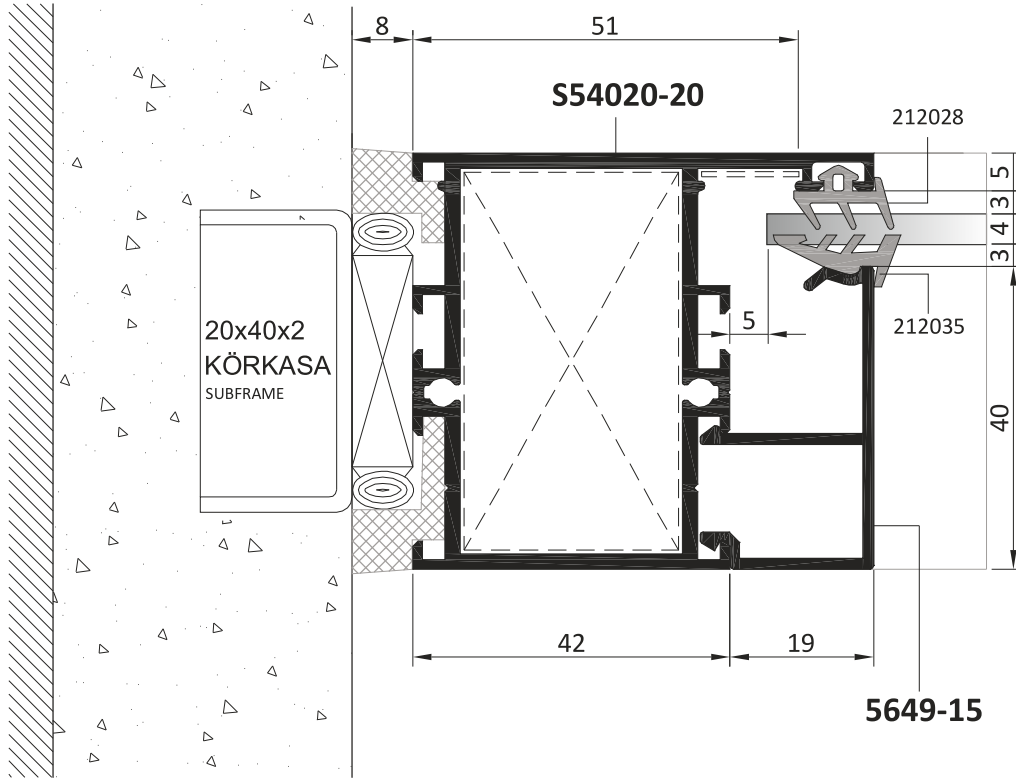

YALITIMSIZ SİSTEM DETAYLARI UNINSULATED SYSTEM DETAILS

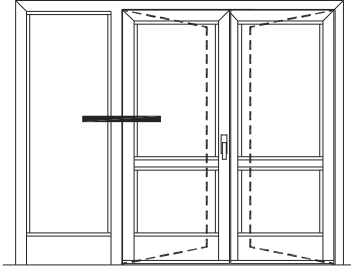

DIŞA AÇILIR HEMYÜZ KAPI
OUTWARD OPENING FLUSH DOOR

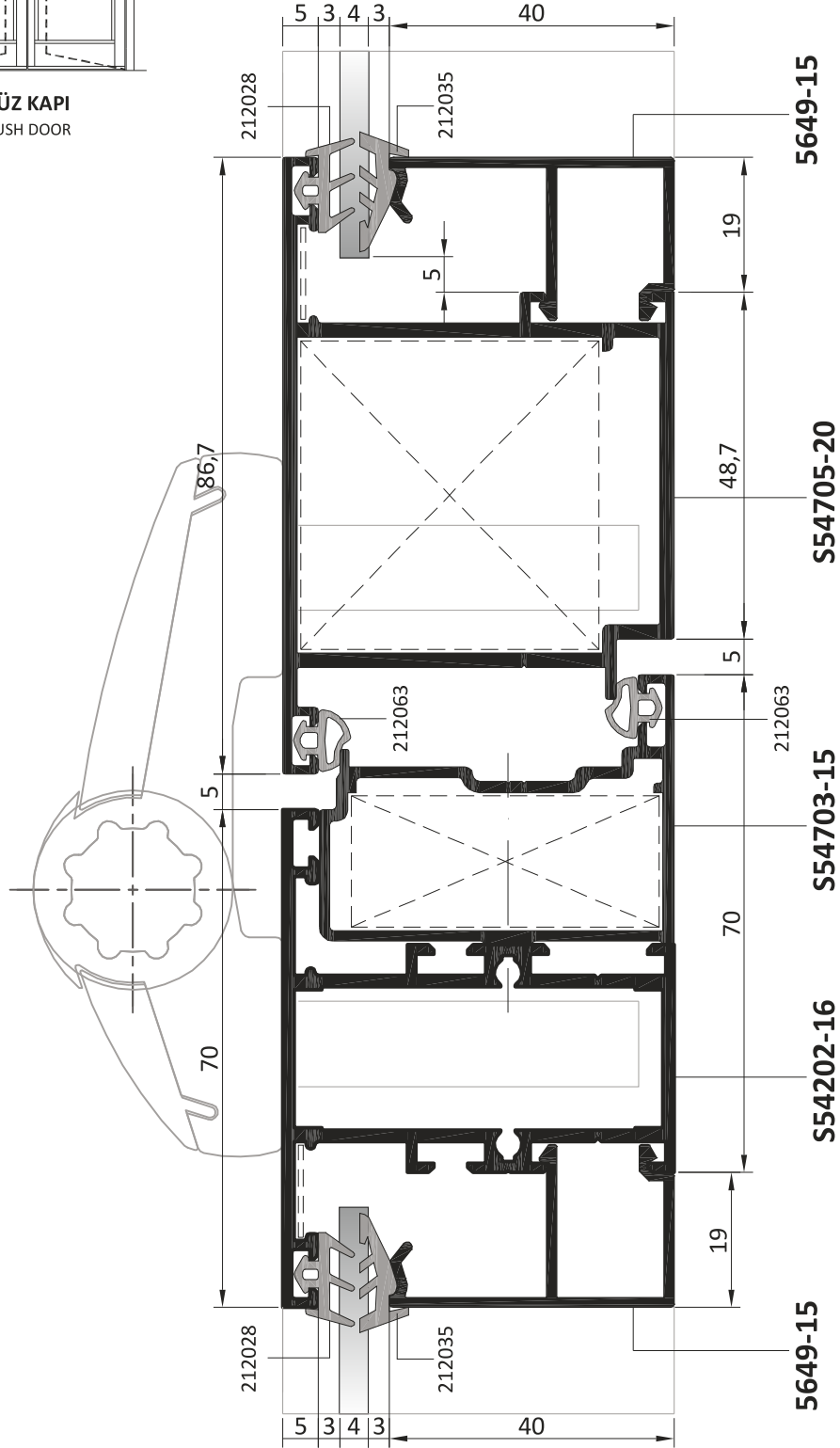

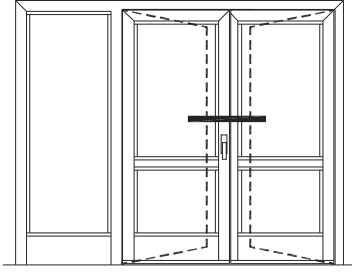

DIŐA AÇILIR HEMYÜZ KAPI
OUTWARD OPENING FLUSH DOOR

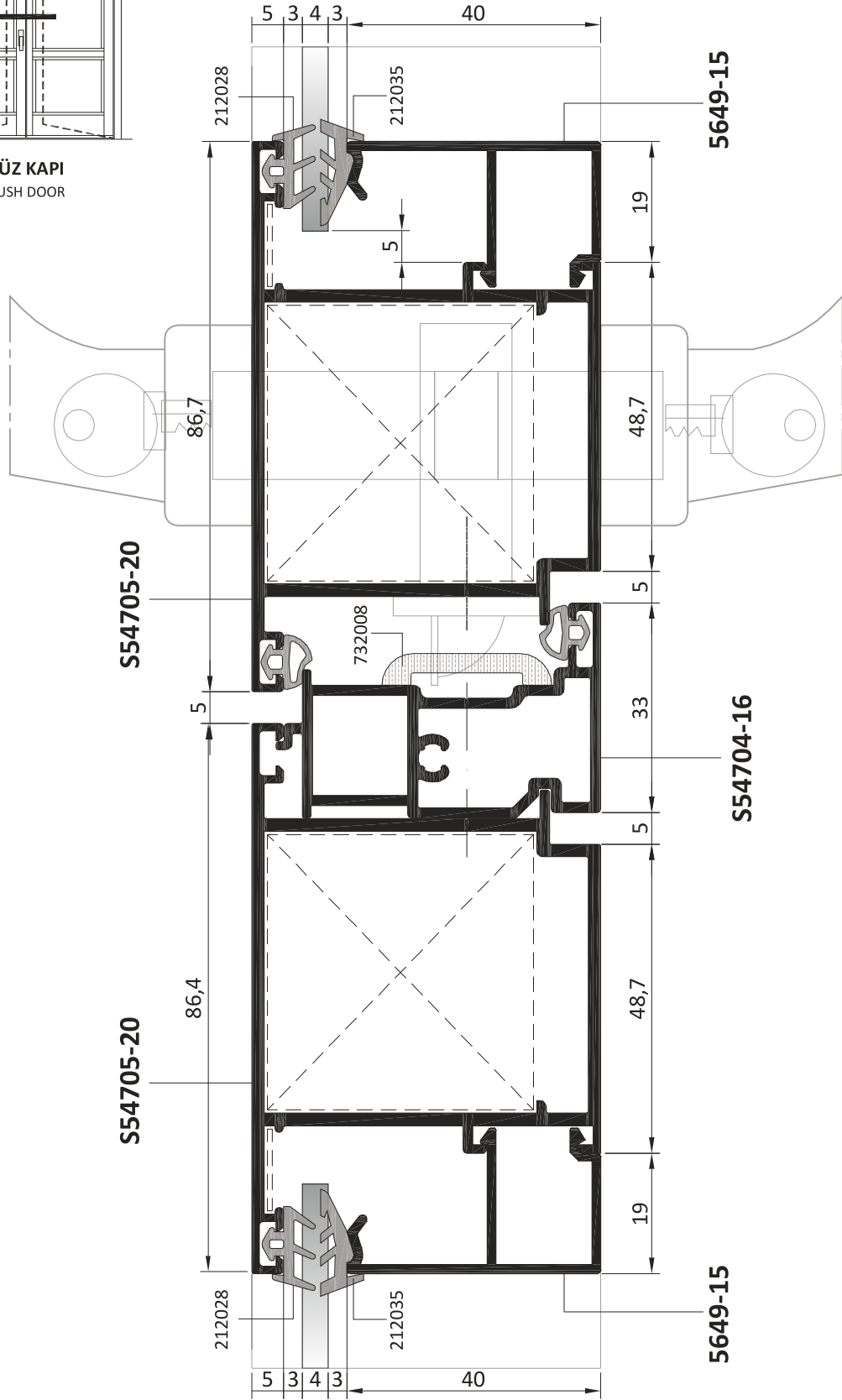

YALITIMSIZ SİSTEM DETAYLARI UNINSULATED SYSTEM DETAILS

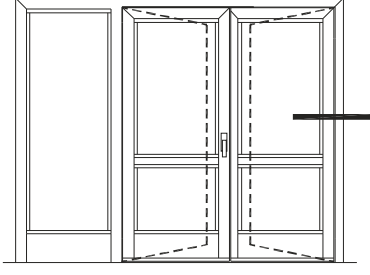

DIŞA AÇILIR HEMYÜZ KAPI
OUTWARD OPENING FLUSH DOOR

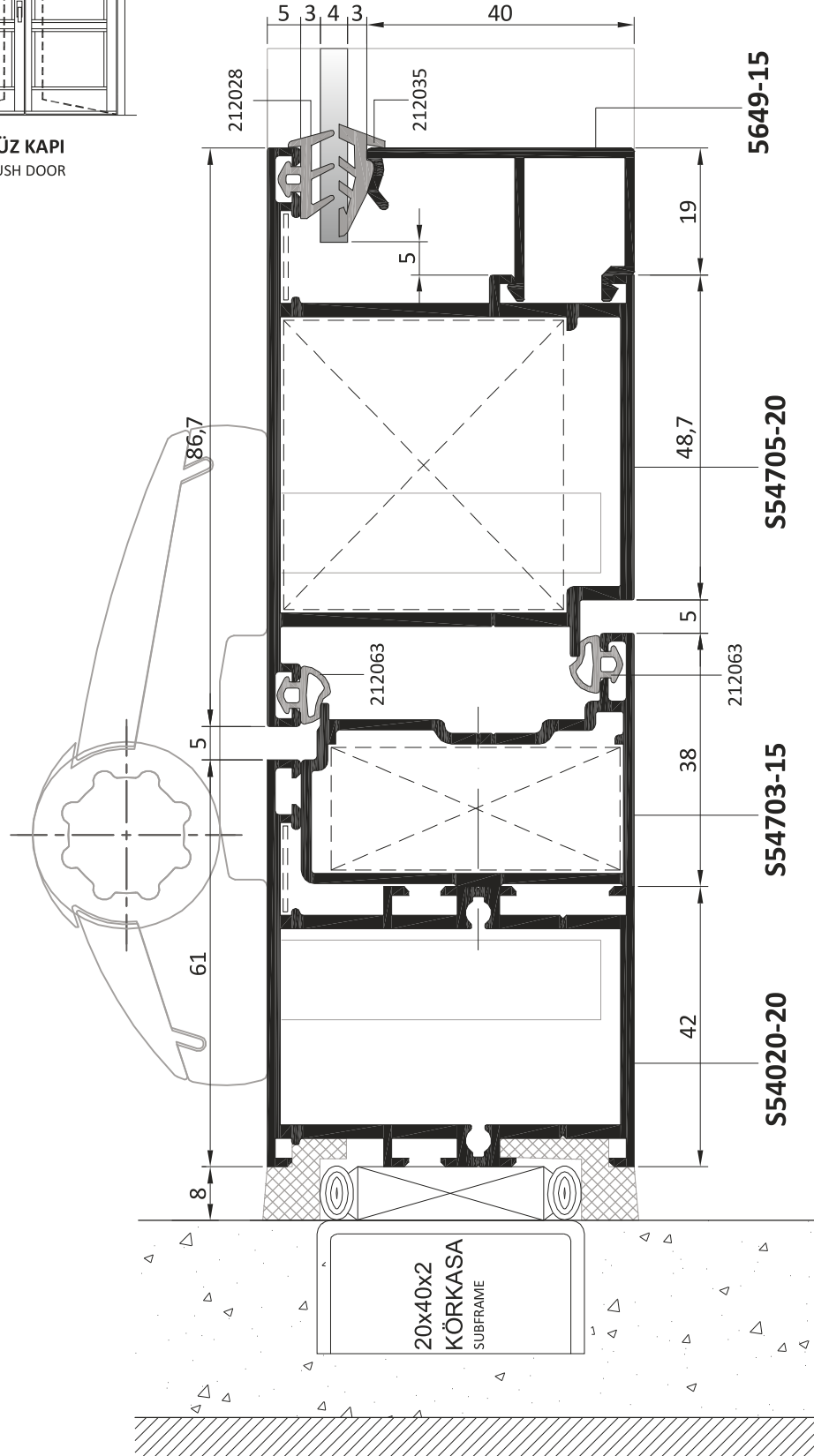

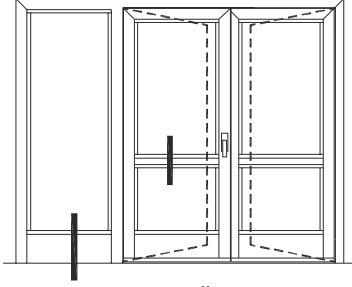

DIŐA AÇILIR HEMYÜZ KAPI
OUTWARD OPENING FLUSH DOOR

YALITIMSIZ SİSTEM DETAYLARI
UNINSULATED SYSTEM DETAILS

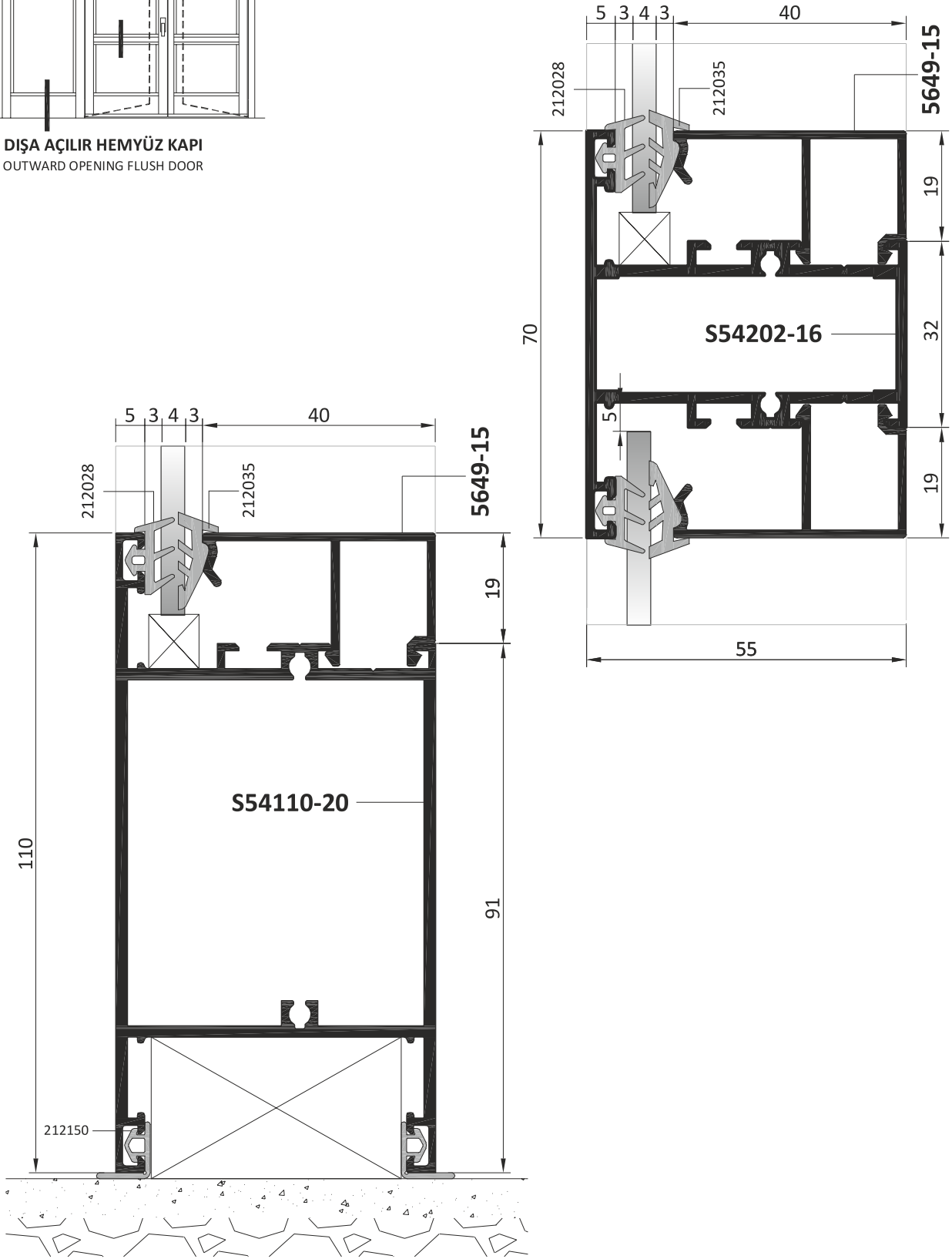

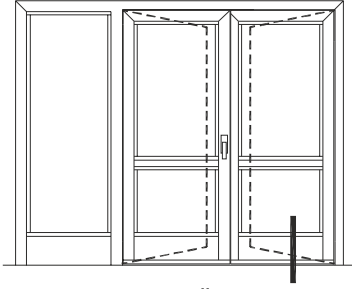

DIŐA AÇILIR HEMYÜZ KAPI
OUTWARD OPENING FLUSH DOOR

YALITIMSIZ SİSTEM DETAYLARI

UNINSULATED SYSTEM DETAILS

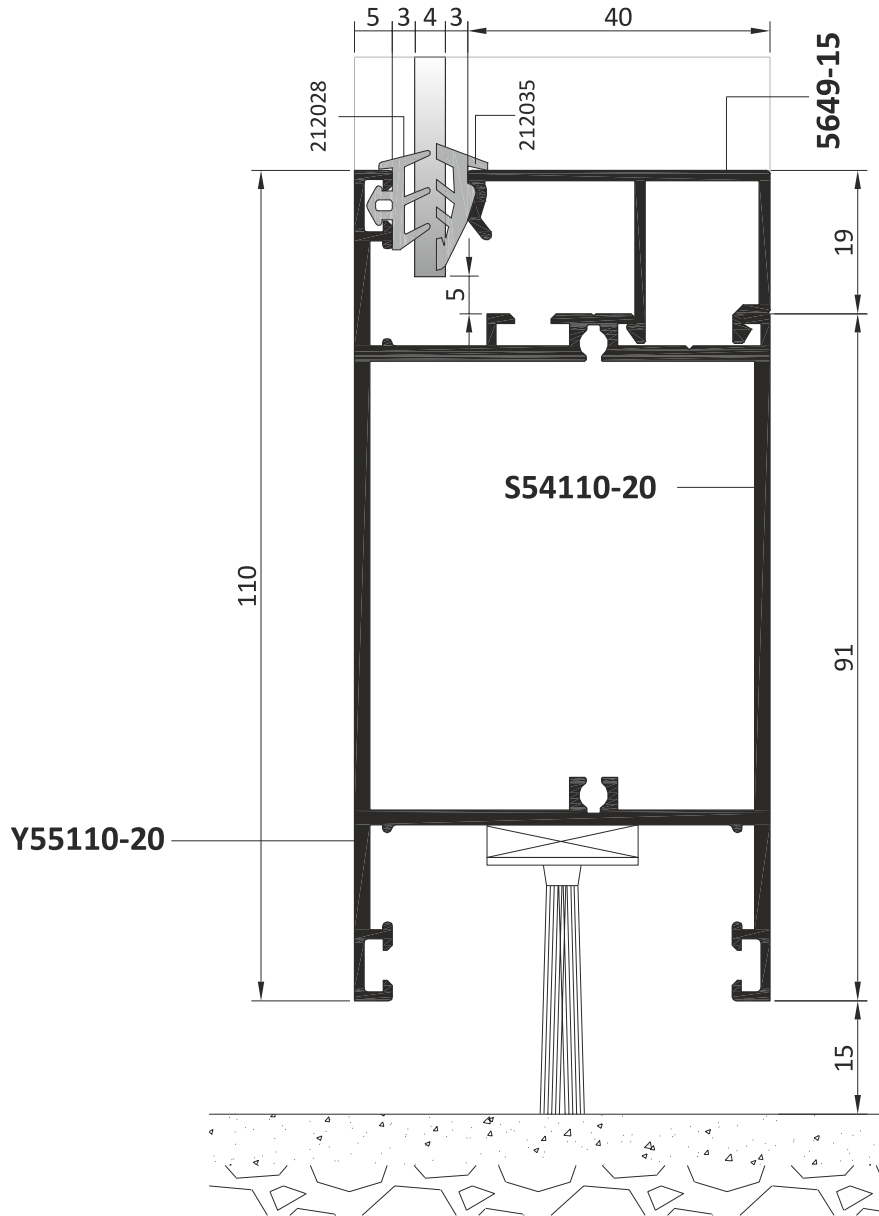

AKSESUARLAR ACCESSORIES

146

AKSESUAR FİHRİSTİ / ACCESSORY INDEX

ÜRÜN KODU PRODUCT CODE	ÜRÜN ADI PRODUCT NAME	SAYFA NO PAGE NO
111018	KÖŞE TAKOZU 53,4 mm - 5680-14 / CORNER CLEAT	155
111023	KÖŞE TAKOZU 23,1 mm - 5580-19 / CORNER CLEAT	156
111027	KÖŞE TAKOZU 27,2 mm - 5680-29 / CORNER CLEAT	158
111029	KÖŞE TAKOZU 52,5 mm - 5680-29 / CORNER CLEAT	159
111031	KÖŞE TAKOZU 9,5 mm - 5680-29 / CORNER CLEAT	157
111033	KÖŞE TAKOZU 9,7 mm - 5680-29 / CORNER CLEAT	157
111036	KÖŞE TAKOZU 7 mm - 5680-44 / CORNER CLEAT	159
111038	KÖŞE TAKOZU 9,5 mm - 5680-44 / CORNER CLEAT	159
111040	KÖŞE TAKOZU 27,1 mm - 5680-44 / CORNER CLEAT	159
111041	KÖŞE TAKOZU 52,9 mm - 5680-44 / CORNER CLEAT	160
111064	KÖŞE TAKOZU 23,1 mm - 5680-14/ CORNER CLEAT	154
111065	KÖŞE TAKOZU 8,9 mm - 5680-24/ CORNER CLEAT	156
111067	KÖŞE TAKOZU 27,3 mm - 5680-24/ CORNER CLEAT	157
111068	KÖŞE TAKOZU 7 mm - 5680-24/ CORNER CLEAT	156
111069	KÖŞE TAKOZU 23,9 mm - 5680-44/ CORNER CLEAT	159
111072	KÖŞE TAKOZU 22,6 mm - 5680-24/ CORNER CLEAT	157
111078	KÖŞE TAKOZU 9,5 mm - 5580-19/ CORNER CLEAT	155
111080	KÖŞE TAKOZU 6,2 mm - 5580-49 CORNER CLEAT	159
111081	KÖŞE TAKOZU 6,6 mm - 5680-29/ CORNER CLEAT	157
111084	KÖŞE TAKOZU 52,1 mm - 5375-15,3/ CORNER CLEAT	161
111085	KÖŞE TAKOZU 52,5 mm - 5580-19/ CORNER CLEAT	156
111086	KÖŞE TAKOZU 6,6 mm - 5680-14/ CORNER CLEAT	154
111087	KÖŞE TAKOZU 26,5 mm - 5580-19/ CORNER CLEAT	156
111088	KÖŞE TAKOZU 6,2 mm - 5580-19/ CORNER CLEAT	155
111093	KÖŞE TAKOZU 8,9 mm - 5680-29/ CORNER CLEAT	157
111095	KÖŞE TAKOZU 7 mm - 5580-19/ CORNER CLEAT	155
111096	KÖŞE TAKOZU 50,6 mm - 5580-19/ CORNER CLEAT	156
111109	KÖŞE TAKOZU 51 mm - 5580-19/ CORNER CLEAT	156
111110	KÖŞE TAKOZU 22,3 mm - 5580-19/ CORNER CLEAT	155
111111	KÖŞE TAKOZU 8,9 mm - 5580-19/ CORNER CLEAT	155
111112	KÖŞE TAKOZU 27,3 mm - 5580-19/ CORNER CLEAT	156
111115	KÖŞE TAKOZU 45,7 mm - 5680-14/ CORNER CLEAT	155
111116	KÖŞE TAKOZU 17,5 mm - 5680-14/ CORNER CLEAT	154
111117	KÖŞE TAKOZU 9,3 mm - 5680-14/ CORNER CLEAT	154
111119	KÖŞE TAKOZU 8,9 mm - 5680-14/ CORNER CLEAT	154
111120	KÖŞE TAKOZU 28,3 mm - 5680-14/ CORNER CLEAT	154

AKSESUAR FİHRİSTİ / ACCESSORY INDEX

ÜRÜN KODU PRODUCT CODE	ÜRÜN ADI PRODUCT NAME	SAYFA NO PAGE NO
111122	KÖŞE TAKOZU 52,5 mm - 5680-14 / CORNER CLEAT	155
111123	KÖŞE TAKOZU 26,9 mm - 5680-14 / CORNER CLEAT	154
111125	KÖŞE TAKOZU 51 mm - 5680-29 / CORNER CLEAT	158
111126	KÖŞE TAKOZU 50,6 mm - 5680-29 / CORNER CLEAT	158
111128	KÖŞE TAKOZU 23,1 mm - 5680-29 / CORNER CLEAT	158
111129	KÖŞE TAKOZU 22,7 mm - 5680-29 / CORNER CLEAT	158
111130	KÖŞE TAKOZU 9,3 mm - 5680-29 / CORNER CLEAT	157
111131	KÖŞE TAKOZU 23,9 mm - 5680-29 / CORNER CLEAT	157
111134	KÖŞE TAKOZU 26,5 mm - 5680-29 / CORNER CLEAT	158
111135	KÖŞE TAKOZU 6,2 mm - 5680-29 / CORNER CLEAT	157
111141	KÖŞE TAKOZU 22,3 mm - 5680-29 / CORNER CLEAT	158
111143	KÖŞE TAKOZU 51,8 mm - 5680-29 / CORNER CLEAT	159
111150	KÖŞE TAKOZU 23,5 mm - 5580-49 / CORNER CLEAT	160
111152	KÖŞE TAKOZU 52,1 mm - 5680-59 / CORNER CLEAT	160
111170	KÖŞE TAKOZU 26,5 mm - 5580-49 / CORNER CLEAT	160
111172	KÖŞE TAKOZU 22,3 mm - 5580-49 / CORNER CLEAT	160
111173	KÖŞE TAKOZU 8,9 mm - 5580-49 / CORNER CLEAT	160
111175	KÖŞE TAKOZU 50,6 mm - 5580-49 / CORNER CLEAT	160
111213	KÖŞE TAKOZU 52,8 mm - 5680-29 / CORNER CLEAT	159
111214	KÖŞE TAKOZU 53,2 mm - 5680-29 / CORNER CLEAT	159
111215	KÖŞE TAKOZU 6,5 mm - 5680-24 / CORNER CLEAT	162
111216	KÖŞE TAKOZU 27 mm - 5580-19 / CORNER CLEAT	161
111217	KÖŞE TAKOZU 43,8 mm - 5580-19 / CORNER CLEAT	161
111218	KÖŞE TAKOZU 4,6 mm - 5680-44 / CORNER CLEAT	161
111219	KÖŞE TAKOZU 7,6 mm - 5680-44 / CORNER CLEAT	161
111220	KÖŞE TAKOZU 18,5 mm - 5680-44 / CORNER CLEAT	161
111221	KÖŞE TAKOZU 26 mm - 5680-44 / CORNER CLEAT	161
111222	KÖŞE TAKOZU 42,5 mm - 5680-44 / CORNER CLEAT	162
111223	KÖŞE TAKOZU 43 mm - 5680-44 / CORNER CLEAT	162
111224	KÖŞE TAKOZU 26,5 mm - 5375-15,3 / CORNER CLEAT	161
111225	KÖŞE TAKOZU 7 mm - 5680-29 / CORNER CLEAT	162
111226	KÖŞE TAKOZU 9,7 mm - 5680-14 / CORNER CLEAT	154
151030	U BAĞLANTI 19 mm / U CONNECTION	154
151031	U BAĞLANTI 29 mm / U CONNECTION	163
151032	U BAĞLANTI 49 mm / U CONNECTION	163
151033	U BAĞLANTI 14 mm / U CONNECTION	163

AKSESUAR FİHRİSTİ / ACCESSORY INDEX









ÜRÜN KODU PRODUCT CODE	ÜRÜN ADI PRODUCT NAME	SAYFA NO PAGE NO
151034	U BAĞLANTI 19 mm / U CONNECTION	163
151035	U BAĞLANTI 24 mm / U CONNECTION	163
151036	U BAĞLANTI 29 mm / U CONNECTION	163
151037	U BAĞLANTI 49 mm / U CONNECTION	163
162002	KÖŞE ÇAVUŞU 13,8 x 1,5 mm / CORNER ALIGNMENT	162
212028	DIŞ CAM FİTİLİ / OUTER GLAZING GASKET	153
212030	KASA FİTİLİ / GASKET FOR FRAME	153
212032	KASA FİTİLİ / GASKET FOR FRAME	153
212035	İÇ CAM FİTİLİ / INNER GLAZING GASKET	153
212057	ORTA BİNİ FİTİLİ (YALITIMLI) / CENTRAL STEP GASKET FOR INSULATED PROFILES	153
212063	KASA FİTİLİ / GASKET FOR FRAME	153
212161	ORTA BİNİ FİTİLİ (YALITIMSIZ) / CENTRAL STEP GASKET FOR UNINSULATED PROFILES	153
322022	TAHLİYE KAPAĞI / DRAINAGE SLOT COVER	174
332045	ÇİFT KANAT ORTA ADAPTÖR TAPASI / ADAPTER PLUG FOR FOUBLKE VENT WINDOWS	175
411002	BURAK SİSTEM PENCERE MENTEŞESİ / BURAK SYSTEM WINDOW HINGE	177
412008	PENCERE MENTEŞESİ / WINDOW HINGE	177
412010	PİVOT MENTEŞE / PIVOT HINGE	178
412013	PENCERE MENTEŞESİ / WINDOW HINGE	177
413004	FLASH BASE PENCERE MENTEŞESİ / FLASH BASE WINDOW HINGE	176
413005	FRIBLOK PİVOT MENTEŞE / FRIBLOK PIVOT HINGE	177
421001	PENCERE MENTEŞESİ / WINDOW HINGE	178
422009	BURAK SİSTEM KAPI MENTEŞESİ / BURAK SYSTEM DOOR HINGE	178
422012	AYARLI KAPI MENTEŞESİ / ADJUSTABLE DOOR HINGE	178
422015	HEMYÜZ KAPI MENTEŞESİ / HINGE FOR FLUSH DOOR	177
422016	BİNİLİ KAPI MENTEŞESİ / STEP HINGE FOR DOOR	177
422019	HEMYÜZ KAPI MENTEŞESİ / HINGE FOR FLUSH DOOR	178
422020	BİNİLİ KAPI MENTEŞESİ / STEP HINGE FOR DOOR	178
422021	DIŞA AÇILIR HEMYÜZ KAPI MENTEŞESİ / OUTWARD OPENING HINGE FOR FLUSH DOORS	178
423003	BRIDGE 2 MENTEŞE / BRIDGE 2 HINGE	176
423004	FLASH XL KAPI MENTEŞESİ / FLASH XL DOOR HINGE	176
423005	DOMINA HP 62,5 mm KAPI MENTEŞESİ / DOMINA HP DOOR HINGE	176
423006	DOMINA CLASSIC 62,5 mm KAPI MENTEŞESİ / DOMINA CLASSIC DOOR HINGE	176
423007	DOMINA MENTEŞE MONTAJ KİTİ / DOMINA HINGE COUNTERPLATE KIT	176
423008	DOMINA MENTEŞE M12x55 BAĞLANTI VİDASI / DIRECT SCREW FOR DOMINA HINGE	176
423009	DOMINA MENTEŞE TELESKOPIK BAĞLANTI VİDASI / TELESCOPIC SCREW FOR OUTWARD OPENING	177
423010	DOMINA MENTEŞE 10MM BURÇLU BİNİ PARÇASI / DOMINA STEP 10 WITH BUSHES	177

AKSESUAR FİHRİSTİ / ACCESSORY INDEX

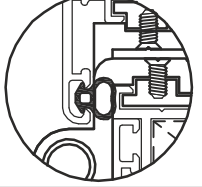
ÜRÜN KODU PRODUCT CODE	ÜRÜN ADI PRODUCT NAME	SAYFA NO PAGE NO
423011	DOMINA MENTEŞE 10MM BİNİ PARÇASI / DOMINA STEP 10 WITHOUT BUSHES	177
423012	DOMINA HP 78 mm KAPI MENTEŞESİ / DOMINA HP DOOR HINGE	176
423013	DOMINA CLASSIC 78 mm KAPI MENTEŞESİ / DOMINA CLASSIC DOOR HINGE	176
452004	VASİSTAS MAKAS / ARM FOR BOTTOM-HUNG WINDOW	183
452005	ALÜMİNYUM VASİSTAS MAKAS / ARM FOR BOTTOM-HUNG WINDOW	183
453001	RALLENTY VASİSTAS MAKAS 150 mm / RALLENTY ARM FOR BOTTOM-HUNG WINDOW	183
453002	RALLENTY VASİSTAS MAKAS 250 mm / RALLENTY ARM FOR BOTTOM-HUNG WINDOW	183
503001	CLASSIC 3D ÇİFT AÇILIM SETİ / CLASSIC 3D TILT AND TURN OPENING KIT	165
503002	CLASSIC 3D ÇİFT AÇILIM SETİ / CLASSIC 3D TILT AND TURN OPENING KIT	165
503003	CLASSIC 3D ÇİFT AÇILIM SETİ / CLASSIC 3D TILT AND TURN OPENING KIT	165
503004	CLASSIC 3D ÇİFT AÇILIM SETİ / CLASSIC 3D TILT AND TURN OPENING KIT	165
503005	CLASSIC 3D AKILLI ÇİFT AÇILIM SETİ / CLASSIC 3D LOGICA TILT AND TURN OPENING KIT	166
503006	CLASSIC 3D AKILLI ÇİFT AÇILIM SETİ / CLASSIC 3D LOGICA TILT AND TURN OPENING KIT	166
503008	UNIJET PVC ÇİFT AÇILIM SETİ / UNIJET PVC TILT AND TURN OPENING KIT	166
503009	UNIJET PVC ÇİFT AÇILIM SETİ / UNIJET PVC TILT AND TURN OPENING KIT	166
533004	KATLANIR KAPI VE PENCERE AKSESUAR SETİ / FOLDING DOOR&WINDOW ACCESSORY KIT	169
543005	PARALEL SÜRME AKSESUAR SETİ / PARALLEL SLIDE AND TILT KIT	168
562002	KALE KAPI KAPATICI 3 / KALE DOOR CLOSER 3	186
562003	KALE KAPI KAPATICI 4 / KALE DOOR CLOSER 4	186
562004	KALE KAYAR KOLLU KAPI KAPATICI 3 / KALE DOOR CLOSER WITH SLIDING ARM 3	186
562005	KALE KAYAR KOLLU KAPI KAPATICI 4 / KALE DOOR CLOSER WITH SLIDING ARM 4	186
572001	PANİK BAR / PANIC DEVICE	186
572003	ÇİFT KANAT PANİK BAR / PANIC DEVICE FOR DOUBLE SASH	186
572005	PANİK ÇIKIŞ İÇİN DIŞ KOL / OUTER HANDLE FOR PANIC DEVICE	186
612013	ÇİFT MAÇALI EKSENEL KOL / TWO WAY CREMONE	182
612016	ÇİFT MAÇALI SÖKÜLEBİLİR KOL / GRIP HANDLE	182
612017	ÇİFT MAÇALI SÖKÜLEBİLİR KOL SAPI / GPULL HANDLE FOR 612016	182
612018	ÇİFT MAÇALI EKSENEL KOL / TWO WAY CREMONE	182
613004	EURO SÖKÜLEBİLİR KOL / EURO GRIP HANDLE	180
613005	EURO SÖKÜLEBİLİR KOL SAPI / PULL HANDLE FOR EURO GRIP HANDLE	180
613008	EURO ÇİFT MAÇALI KOL / EURO TWO-WAY CREMONE	179
613011	PRIMA ÇİFT MAÇALI KOL / PRIMA TWO-WAY CREMONE	179
613012	PRIMA ÇİFT MAÇALI ANAHTARLI KOL / PRIMA TWO-WAY CREMONE WITH KEY	179
613013	PRIMA ÇİFT MAÇALI KOL / PRIMA TWO-WAY CREMONE	179
613014	UNICA ÇİFT MAÇALI ANAHTARLI KOL / UNICA TWO-WAY CREMONE WITH KEY	180
613015	ASIA ÇİFT MAÇALI KOL / ASIA TWO-WAY CREMONE	180

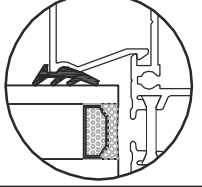
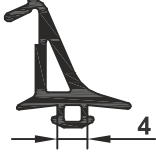
AKSESUAR FİHRİSTİ / ACCESSORY INDEX

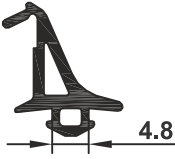
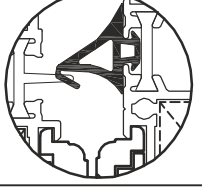
ÜRÜN KODU PRODUCT CODE	ÜRÜN ADI PRODUCT NAME	SAYFA NO PAGE NO
613016	ASIA ÇİFT MAÇALI ANAHTARLI KOL / ASIA TWO-WAY CREMONE WITH KEY	180
613017	ASIA SÖKÜLEBİLİR KOL / ASIA GRIP HANDLE	181
613018	TREND ÇİFT MAÇALI KOL / TREND TWO-WAY CREMONE	180
613021	ASIA SÖKÜLEBİLİR KOL SAPI / PULL HANDLE FOR ASIA GRIP HANDLE	181
613022	EURO TEK MAÇALI KOL / EURO ONE-WAY CREMONE	179
613023	PRIMA TEK MAÇALI KOL / PRIMA ONE-WAY CREMONE	179
613024	PRIMA TEK ANAHTARLI MAÇALI KOL / PRIMA ONE-WAY CREMONE WITH KEY	179
613025	ASIA TEK MAÇALI KOL / ASIA ONE-WAY CREMONE	180
613026	ASIA AKILLI ÇİFT AÇILIM KOLU / ASIA ONE-WAY CREMONE FOR LOGICAL T&T	180
613027	UNICA TEK MAÇALI KOL / UNICA ONE-WAY CREMONE	179
613028	TREND TEK MAÇALI KOL / TREND ONE-WAY CREMONE	179
613029	UNICA SÖKÜLEBİLİR KOL / UNICA GRIP HANDLE	179
613030	UNICA SÖKÜLEBİLİR KOL SAPI / PULL HANDLE FOR UNICA GRIP HANDLE	181
613031	PRIMA PENCERE KOLU / PRIMA WINDOW HANDLE	187
622125	KAPI KOLU / DOOR HANDLE	182
622130	BAREL ROZETİ / CYLINDER COVER PLATE	182
622134	KAPI KOLU / DOOR HANDLE	182
622135	KAPI KOLU / DOOR HANDLE	182
622136	BAREL ROZETİ / CYLINDER COVER PLATE	182
623002	PRIMA KAPI KOLU / PRIMA DOOR HANDLE	181
623003	SUPERMASTER KAPI KOLU / SUPERMASTER DOOR HANDLE	181
623004	FLORA KAPI KOLU / FLORA DOOR HANDLE	181
623005	PRIMA KAPI KOLU / PRIMA DOOR HANDLE	181
623006	PRIMA KAPI KOLU / PRIMA DOOR HANDLE	181
623007	FLORA BAREL ROZETİ / FLORA CYLINDER COVER PLATE	181
642003	ÇİFT MAÇALI KOL BAĞLANTILARI / TWO-WAY DRIVE ROD COMPONENTS	185
643003	GIESSE TEK MAÇALI KOL BAĞLANTILARI / GIESSE PULL DEVICE FOR ONE-WAY CREMONE	184
643004	GIESSE ÇİFT MAÇALI KOL BAĞLANTILARI / GIESSE TWO-WAY DRIVE ROD COMPONENTS	184
643005	GHIBO OUT KOL MEKANİZMASI / LGHIBO OUT TWO-WAY MECHANISM FOR OUTWARD OPENNING	187
712009	KALE 153U DİLLİ KİLİT / LOCK WITH RAIL	172
712015	KALE 155U MAKARALI KİLİT / LOCK WITH ROLLER	172
722038	KALE 164 SNC BAREL (71mm) / CYLINDER	172
722039	KALE 164 SNC BAREL (81mm) / CYLINDER	172
732002	AYARLI KİLİTLEME PİMİ / ADJUSTABLE FASTENING PAWL	184
732003	KÖŞE İLETİM PARÇASI / CORNER DEVICE	185
732007	AYARLI KARŞILIK / ADJUSTABLE STRIKER	185

EPDM FİTİLLER / EPDM GASKETS		
ÇİZİM / DRAWING	AKSESUAR KODU VE ÜRÜN BİLGİLERİ / ACCESSORY CODE AND PRODUCT DESCRIPTION	TAKILMA BÖLGESİ APPLICATION AREA
	212028 DIŞ CAM FİTİLİ / OUTER GLAZING GASKET BİRİM AĞIRLIK / UNIT WEIGHT : 55 g/m KOLİ MİKTARI / PACKAGE QUANTITY : 270 m	
	212030 KASA FİTİLİ / GASKET FOR FRAME BİRİM AĞIRLIK / UNIT WEIGHT : 35 g/m KOLİ MİKTARI / PACKAGE QUANTITY : 425 m	
	212032 KASA FİTİLİ / GASKET FOR FRAME BİRİM AĞIRLIK / UNIT WEIGHT : 33 g/m KOLİ MİKTARI / PACKAGE QUANTITY : 450 m	
	212035 İÇ CAM FİTİLİ 4 mm / INNER STEP GASKET BİRİM AĞIRLIK / UNIT WEIGHT : 63 g/m KOLİ MİKTARI / PACKAGE QUANTITY : 250 m	
	212029 İÇ CAM FİTİLİ 2 mm / INNER STEP GASKET BİRİM AĞIRLIK / UNIT WEIGHT : 33 g/m KOLİ MİKTARI / PACKAGE QUANTITY : 450 m	
	212057 ORTA BİNİ FİTİLİ (YALITIMLI) / CENTRAL STEP GASKET FOR INSULATED BİRİM AĞIRLIK / UNIT WEIGHT : 83 g/m KOLİ MİKTARI / PACKAGE QUANTITY : 180 m	
	212161 ORTA BİNİ FİTİLİ (YALITIMSIZ) / CENTRAL STEP GASKET FOR UNISULATED BİRİM AĞIRLIK / UNIT WEIGHT : 86 g/m KOLİ MİKTARI / PACKAGE QUANTITY : 180 m	
	212063 KASA FİTİLİ / GASKET FOR FRAME BİRİM AĞIRLIK / UNIT WEIGHT : 35 g/m KOLİ MİKTARI / PACKAGE QUANTITY : 425 m	

KÖŞE TAKOZLARI / CORNER CLEATS

ÇİZİM / DRAWING	AKSESUAR KODU VE ÜRÜN BİLGİLERİ / ACCESSORY CODE AND PRODUCT DESCRIPTION	KESİM ÖLÇÜSÜ CUTTING DIMENSION
	111086 PROFİL NUMARASI / PROFILE NUMBER : 5680-14 PROFİL AĞIRLIĞI / PROFILE WEIGHT : 3,639 kg/m	6,5 mm
	111119 PROFİL NUMARASI / PROFILE NUMBER : 5680-14 PROFİL AĞIRLIĞI / PROFILE WEIGHT : 3,639 kg/m	9 mm
	111117 PROFİL NUMARASI / PROFILE NUMBER : 5680-14 PROFİL AĞIRLIĞI / PROFILE WEIGHT : 3,639 kg/m	9,2 mm
	111226 PROFİL NUMARASI / PROFILE NUMBER : 5680-14 PROFİL AĞIRLIĞI / PROFILE WEIGHT : 3,639 kg/m	9,7 mm
	111116 PROFİL NUMARASI / PROFILE NUMBER : 5680-14 PROFİL AĞIRLIĞI / PROFILE WEIGHT : 3,639 kg/m	17,5 mm
	111064 PROFİL NUMARASI / PROFILE NUMBER : 5680-14 PROFİL AĞIRLIĞI / PROFILE WEIGHT : 3,639 kg/m	23 mm
	111123 PROFİL NUMARASI / PROFILE NUMBER : 5680-14 PROFİL AĞIRLIĞI / PROFILE WEIGHT : 3,639 kg/m	27 mm
	111120 PROFİL NUMARASI / PROFILE NUMBER : 5680-14 PROFİL AĞIRLIĞI / PROFILE WEIGHT : 3,639 kg/m	28,3 mm

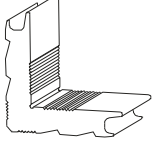
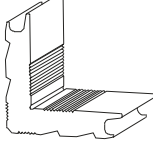
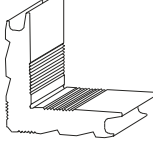
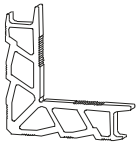
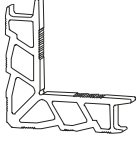
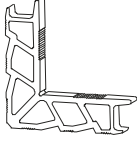
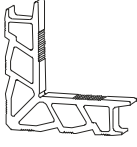
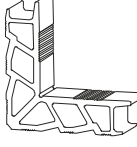
KÖŞE TAKOZLARI / CORNER CLEATS		
ÇİZİM / DRAWING	AKSESUAR KODU VE ÜRÜN BİLGİLERİ / ACCESSORY CODE AND PRODUCT DESCRIPTION	KESİM ÖLÇÜSÜ CUTTING DIMENSION
	111115 PROFİL NUMARASI / PROFILE NUMBER : 5680-14 PROFİL AĞIRLIĞI / PROFILE WEIGHT : 3,639 kg/m	45,7 mm
	111122 PROFİL NUMARASI / PROFILE NUMBER : 5680-14 PROFİL AĞIRLIĞI / PROFILE WEIGHT : 3,639 kg/m	52,5 mm
	111018 PROFİL NUMARASI / PROFILE NUMBER : 5680-14 PROFİL AĞIRLIĞI / PROFILE WEIGHT : 3,639 kg/m	53,4 mm
	111088 PROFİL NUMARASI / PROFILE NUMBER : 5580-19 PROFİL AĞIRLIĞI / PROFILE WEIGHT : 2,700 kg/m	6,2 mm
	111095 PROFİL NUMARASI / PROFILE NUMBER : 5580-19 PROFİL AĞIRLIĞI / PROFILE WEIGHT : 2,700 kg/m	7 mm
	111111 PROFİL NUMARASI / PROFILE NUMBER : 5580-19 PROFİL AĞIRLIĞI / PROFILE WEIGHT : 2,700 kg/m	9 mm
	111078 PROFİL NUMARASI / PROFILE NUMBER : 5580-19 PROFİL AĞIRLIĞI / PROFILE WEIGHT : 2,700 kg/m	9,5 mm
	111110 PROFİL NUMARASI / PROFILE NUMBER : 5580-19 PROFİL AĞIRLIĞI / PROFILE WEIGHT : 2,700 kg/m	22,2 mm

KÖŞE TAKOZLARI / CORNER CLEATS

ÇİZİM / DRAWING	AKSESUAR KODU VE ÜRÜN BİLGİLERİ / ACCESSORY CODE AND PRODUCT DESCRIPTION	KESİM ÖLÇÜSÜ CUTTING DIMENSION
	111023 PROFİL NUMARASI / PROFILE NUMBER : 5580-19 PROFİL AĞIRLIĞI / PROFILE WEIGHT : 2,700 kg/m	23 mm
	111087 PROFİL NUMARASI / PROFILE NUMBER : 5580-19 PROFİL AĞIRLIĞI / PROFILE WEIGHT : 2,700 kg/m	26,5 mm
	111112 PROFİL NUMARASI / PROFILE NUMBER : 5580-19 PROFİL AĞIRLIĞI / PROFILE WEIGHT : 2,700 kg/m	27,2 mm
	111096 PROFİL NUMARASI / PROFILE NUMBER : 5580-19 PROFİL AĞIRLIĞI / PROFILE WEIGHT : 2,700 kg/m	50,6 mm
	111109 PROFİL NUMARASI / PROFILE NUMBER : 5580-19 PROFİL AĞIRLIĞI / PROFILE WEIGHT : 2,700 kg/m	51 mm
	111085 PROFİL NUMARASI / PROFILE NUMBER : 5580-19 PROFİL AĞIRLIĞI / PROFILE WEIGHT : 2,700 kg/m	52,5 mm
	111068 PROFİL NUMARASI / PROFILE NUMBER : 5680-24 PROFİL AĞIRLIĞI / PROFILE WEIGHT : 3,091 kg/m	7 mm
	111065 PROFİL NUMARASI / PROFILE NUMBER : 5680-24 PROFİL AĞIRLIĞI / PROFILE WEIGHT : 3,091 kg/m	9 mm

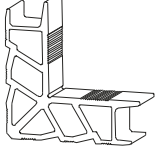
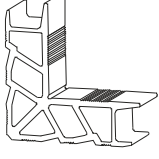
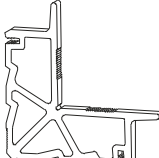
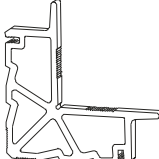
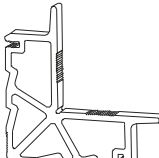
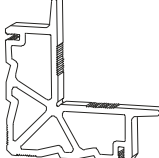
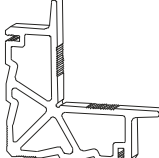
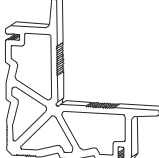
KÖŞE TAKOZLARI / CORNER CLEATS		
ÇİZİM / DRAWING	AKSESUAR KODU VE ÜRÜN BİLGİLERİ / ACCESSORY CODE AND PRODUCT DESCRIPTION	KESİM ÖLÇÜSÜ CUTTING DIMENSION
	111072 PROFİL NUMARASI / PROFILE NUMBER : 5680-24 PROFİL AĞIRLIĞI / PROFILE WEIGHT : 3,091 kg/m	22,6 mm
	111067 PROFİL NUMARASI / PROFILE NUMBER : 5680-24 PROFİL AĞIRLIĞI / PROFILE WEIGHT : 3,091 kg/m	27,2 mm
	111135 PROFİL NUMARASI / PROFILE NUMBER : 5680-29 PROFİL AĞIRLIĞI / PROFILE WEIGHT : 3,875 kg/m	6,2 mm
	111081 PROFİL NUMARASI / PROFILE NUMBER : 5680-29 PROFİL AĞIRLIĞI / PROFILE WEIGHT : 3,875 kg/m	6,6 mm
	111093 PROFİL NUMARASI / PROFILE NUMBER : 5680-29 PROFİL AĞIRLIĞI / PROFILE WEIGHT : 3,875 kg/m	9mm
	111130 PROFİL NUMARASI / PROFILE NUMBER : 5680-29 PROFİL AĞIRLIĞI / PROFILE WEIGHT : 3,875 kg/m	9,2 mm
	111031 PROFİL NUMARASI / PROFILE NUMBER : 5680-29 PROFİL AĞIRLIĞI / PROFILE WEIGHT : 3,875 kg/m	9,5 mm
	111033 PROFİL NUMARASI / PROFILE NUMBER : 5680-29 PROFİL AĞIRLIĞI / PROFILE WEIGHT : 3,875 kg/m	9,7 mm

KÖŞE TAKOZLARI / CORNER CLEATS

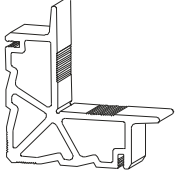
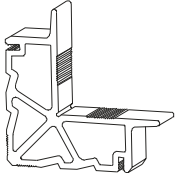
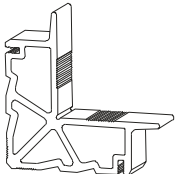
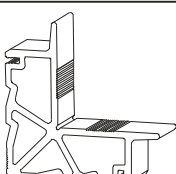
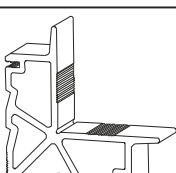
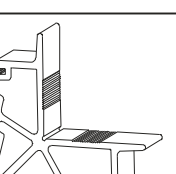
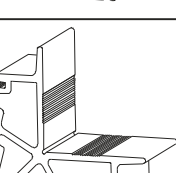
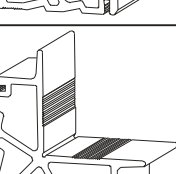
ÇİZİM / DRAWING	AKSESUAR KODU VE ÜRÜN BİLGİLERİ / ACCESSORY CODE AND PRODUCT DESCRIPTION	KESİM ÖLÇÜSÜ CUTTING DIMENSION
	111141 PROFİL NUMARASI / PROFILE NUMBER : 5680-29 PROFİL AĞIRLIĞI / PROFILE WEIGHT : 3,875 kg/m	22,2 mm
	111129 PROFİL NUMARASI / PROFILE NUMBER : 5680-29 PROFİL AĞIRLIĞI / PROFILE WEIGHT : 3,875 kg/m	22,5 mm
	111128 PROFİL NUMARASI / PROFILE NUMBER : 5680-29 PROFİL AĞIRLIĞI / PROFILE WEIGHT : 3,875 kg/m	23 mm
	111131 PROFİL NUMARASI / PROFILE NUMBER : 5680-29 PROFİL AĞIRLIĞI / PROFILE WEIGHT : 3,875 kg/m	24 mm
	111134 PROFİL NUMARASI / PROFILE NUMBER : 5680-29 PROFİL AĞIRLIĞI / PROFILE WEIGHT : 3,875 kg/m	26,5 mm
	111027 PROFİL NUMARASI / PROFILE NUMBER : 5680-29 PROFİL AĞIRLIĞI / PROFILE WEIGHT : 3,875 kg/m	27,2 mm
	111126 PROFİL NUMARASI / PROFILE NUMBER : 5680-29 PROFİL AĞIRLIĞI / PROFILE WEIGHT : 3,875 kg/m	50,6 mm
	111125 PROFİL NUMARASI / PROFILE NUMBER : 5680-29 PROFİL AĞIRLIĞI / PROFILE WEIGHT : 3,875 kg/m	51 mm

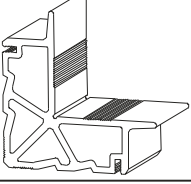
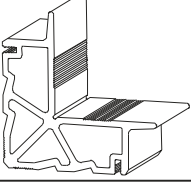
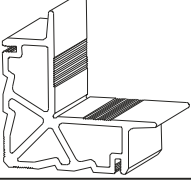
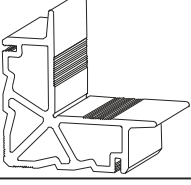
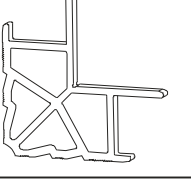
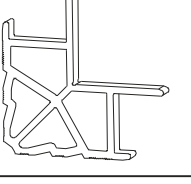
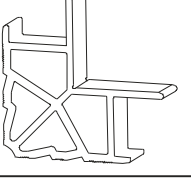
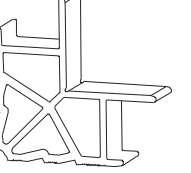
KÖŞE TAKOZLARI / CORNER CLEATS		
ÇİZİM / DRAWING	AKSESUAR KODU VE ÜRÜN BİLGİLERİ / ACCESSORY CODE AND PRODUCT DESCRIPTION	KESİM ÖLÇÜSÜ CUTTING DIMENSION
	111143 PROFİL NUMARASI / PROFILE NUMBER : 5680-29 PROFİL AĞIRLIĞI / PROFILE WEIGHT : 3,875 kg/m	51,8 mm
	111029 PROFİL NUMARASI / PROFILE NUMBER : 5680-29 PROFİL AĞIRLIĞI / PROFILE WEIGHT : 3,875 kg/m	52,5 mm
	111213 PROFİL NUMARASI / PROFILE NUMBER : 5680-29 PROFİL AĞIRLIĞI / PROFILE WEIGHT : 3,875 kg/m	52,8 mm
	111214 PROFİL NUMARASI / PROFILE NUMBER : 5680-29 PROFİL AĞIRLIĞI / PROFILE WEIGHT : 3,875 kg/m	53,2 mm
	111036 PROFİL NUMARASI / PROFILE NUMBER : 5680-44 PROFİL AĞIRLIĞI / PROFILE WEIGHT : 5,240 kg/m	7 mm
	111038 PROFİL NUMARASI / PROFILE NUMBER : 5680-44 PROFİL AĞIRLIĞI / PROFILE WEIGHT : 5,240 kg/m	9,5 mm
	111069 PROFİL NUMARASI / PROFILE NUMBER : 5680-44 PROFİL AĞIRLIĞI / PROFILE WEIGHT : 5,240 kg/m	24,2 mm
	111040 PROFİL NUMARASI / PROFILE NUMBER : 5680-44 PROFİL AĞIRLIĞI / PROFILE WEIGHT : 5,240 kg/m	27,1 mm



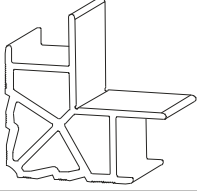
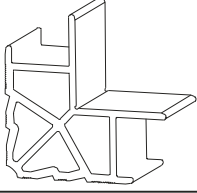
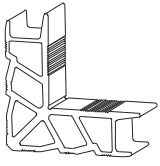
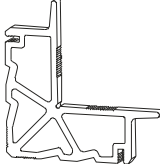

KÖŞE TAKOZLARI / CORNER CLEATS

ÇİZİM / DRAWING	AKSESUAR KODU VE ÜRÜN BİLGİLERİ / ACCESSORY CODE AND PRODUCT DESCRIPTION	KESİM ÖLÇÜSÜ CUTTING DIMENSION
	111041 PROFİL NUMARASI / PROFILE NUMBER : 5680-44 PROFİL AĞIRLIĞI / PROFILE WEIGHT : 5,240 kg/m	53 mm
	111080 PROFİL NUMARASI / PROFILE NUMBER : 5580-49 PROFİL AĞIRLIĞI / PROFILE WEIGHT : 5,427 kg/m	6,2 mm
	111173 PROFİL NUMARASI / PROFILE NUMBER : 5580-49 PROFİL AĞIRLIĞI / PROFILE WEIGHT : 5,427 kg/m	9 mm
	111172 PROFİL NUMARASI / PROFILE NUMBER : 5580-49 PROFİL AĞIRLIĞI / PROFILE WEIGHT : 5,427 kg/m	22,2 mm
	111150 PROFİL NUMARASI / PROFILE NUMBER : 5580-49 PROFİL AĞIRLIĞI / PROFILE WEIGHT : 5,427 kg/m	23,5 mm
	111170 PROFİL NUMARASI / PROFILE NUMBER : 5580-49 PROFİL AĞIRLIĞI / PROFILE WEIGHT : 5,427 kg/m	26,5 mm
	111175 PROFİL NUMARASI / PROFILE NUMBER : 5580-49 PROFİL AĞIRLIĞI / PROFILE WEIGHT : 5,427 kg/m	50,6 mm
	111152 PROFİL NUMARASI / PROFILE NUMBER : 5680-59 PROFİL AĞIRLIĞI / PROFILE WEIGHT : 7,33 kg/m	52 mm

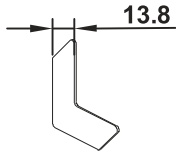
KÖŞE TAKOZLARI / CORNER CLEATS		
ÇİZİM / DRAWING	AKSESUAR KODU VE ÜRÜN BİLGİLERİ / ACCESSORY CODE AND PRODUCT DESCRIPTION	KESİM ÖLÇÜSÜ CUTTING DIMENSION
	111224 PROFİL NUMARASI / PROFILE NUMBER : 5375-15,3 PROFİL AĞIRLIĞI / PROFILE WEIGHT : 2,535 kg/m	26,5 mm
	111084 PROFİL NUMARASI / PROFILE NUMBER : 5375-15,3 PROFİL AĞIRLIĞI / PROFILE WEIGHT : 2,535 kg/m	27,2 mm
	111216 PROFİL NUMARASI / PROFILE NUMBER : 5580-19 PROFİL AĞIRLIĞI / PROFILE WEIGHT : 2,700 kg/m	27 mm
	111217 PROFİL NUMARASI / PROFILE NUMBER : 5580-19 PROFİL AĞIRLIĞI / PROFILE WEIGHT : 2,700 kg/m	43,8 mm
	111218 PROFİL NUMARASI / PROFILE NUMBER : 5680-44 PROFİL AĞIRLIĞI / PROFILE WEIGHT : 5,240 kg/m	4,6 mm
	111219 PROFİL NUMARASI / PROFILE NUMBER : 5680-44 PROFİL AĞIRLIĞI / PROFILE WEIGHT : 5,240 kg/m	7,6 mm
	111220 PROFİL NUMARASI / PROFILE NUMBER : 5680-44 PROFİL AĞIRLIĞI / PROFILE WEIGHT : 5,240 kg/m	18,5 mm
	111221 PROFİL NUMARASI / PROFILE NUMBER : 5680-44 PROFİL AĞIRLIĞI / PROFILE WEIGHT : 5,240 kg/m	26 mm

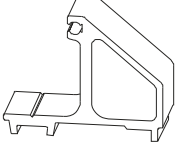
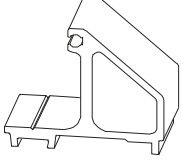
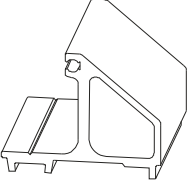
KÖŞE TAKOZLARI / CORNER CLEATS		
ÇİZİM / DRAWING	AKSESUAR KODU VE ÜRÜN BİLGİLERİ / ACCESSORY CODE AND PRODUCT DESCRIPTION	KESİM ÖLÇÜSÜ CUTTING DIMENSION
	111222 PROFİL NUMARASI / PROFILE NUMBER : 5680-44 PROFİL AĞIRLIĞI / PROFILE WEIGHT : 5,240 kg/m	42,5 mm
	111223 PROFİL NUMARASI / PROFILE NUMBER : 5680-44 PROFİL AĞIRLIĞI / PROFILE WEIGHT : 5,240 kg/m	43 mm
	111215 PROFİL NUMARASI / PROFILE NUMBER : 5680-24 PROFİL AĞIRLIĞI / PROFILE WEIGHT : 3,091 kg/m	6,5 mm
	111225 PROFİL NUMARASI / PROFILE NUMBER : 5680-29 PROFİL AĞIRLIĞI / PROFILE WEIGHT : 3,875 kg/m	7 mm

KÖŞE ÇAVUŞU / CORNER ALIGNMENT		
	162002 KÖŞE ÇAVUŞU / CORNER ALIGNMENT	13,8 x 1,5 mm

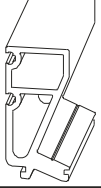
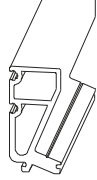
U BAĞLANTILAR / U CONNECTIONS		
ÇİZİM / DRAWING	AKSESUAR KODU VE ÜRÜN BİLGİLERİ / ACCESSORY CODE AND PRODUCT DESCRIPTION	KESİM ÖLÇÜSÜ CUTTING DIMENSION
	151030 PROFİL NUMARASI / PROFILE NUMBER : SZ54170-00 PROFİL AĞIRLIĞI / PROFILE WEIGHT : 0,943 kg/m	19 mm
	151031 PROFİL NUMARASI / PROFILE NUMBER : SZ54170-00 PROFİL AĞIRLIĞI / PROFILE WEIGHT : 0,943 kg/m	29 mm
	151032 PROFİL NUMARASI / PROFILE NUMBER : SZ54170-00 PROFİL AĞIRLIĞI / PROFILE WEIGHT : 0,943 kg/m	49 mm
	151033 PROFİL NUMARASI / PROFILE NUMBER : 20300 PROFİL AĞIRLIĞI / PROFILE WEIGHT : 0,264 kg/m	14 mm
	151034 PROFİL NUMARASI / PROFILE NUMBER : 20300 PROFİL AĞIRLIĞI / PROFILE WEIGHT : 0,264 kg/m	19 mm
	151035 PROFİL NUMARASI / PROFILE NUMBER : 20300 PROFİL AĞIRLIĞI / PROFILE WEIGHT : 0,264 kg/m	24 mm
	151036 PROFİL NUMARASI / PROFILE NUMBER : 20300 PROFİL AĞIRLIĞI / PROFILE WEIGHT : 0,264 kg/m	29 mm
	151037 PROFİL NUMARASI / PROFILE NUMBER : 20300 PROFİL AĞIRLIĞI / PROFILE WEIGHT : 0,264 kg/m	49 mm

U BAĞLANTI MONTAJ ŞEKLİ

INSTALLATION INSTRUCTIONS FOR THE U CONNECTION

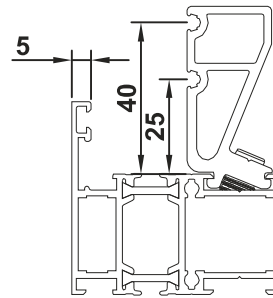
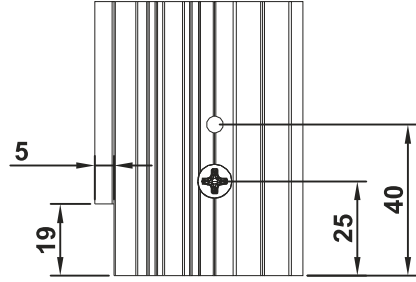
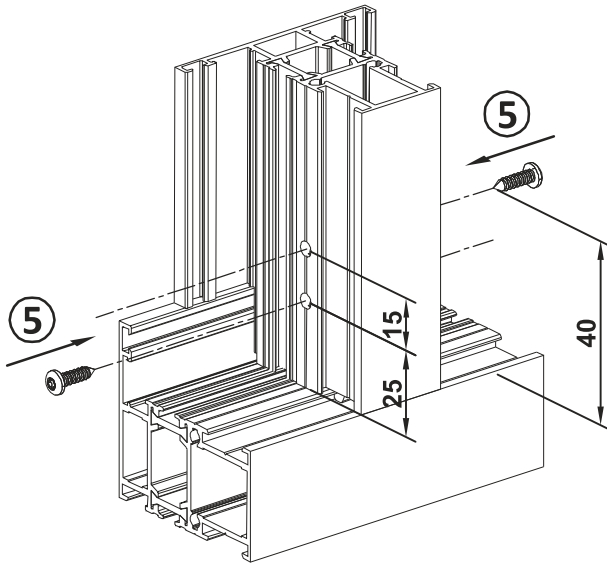
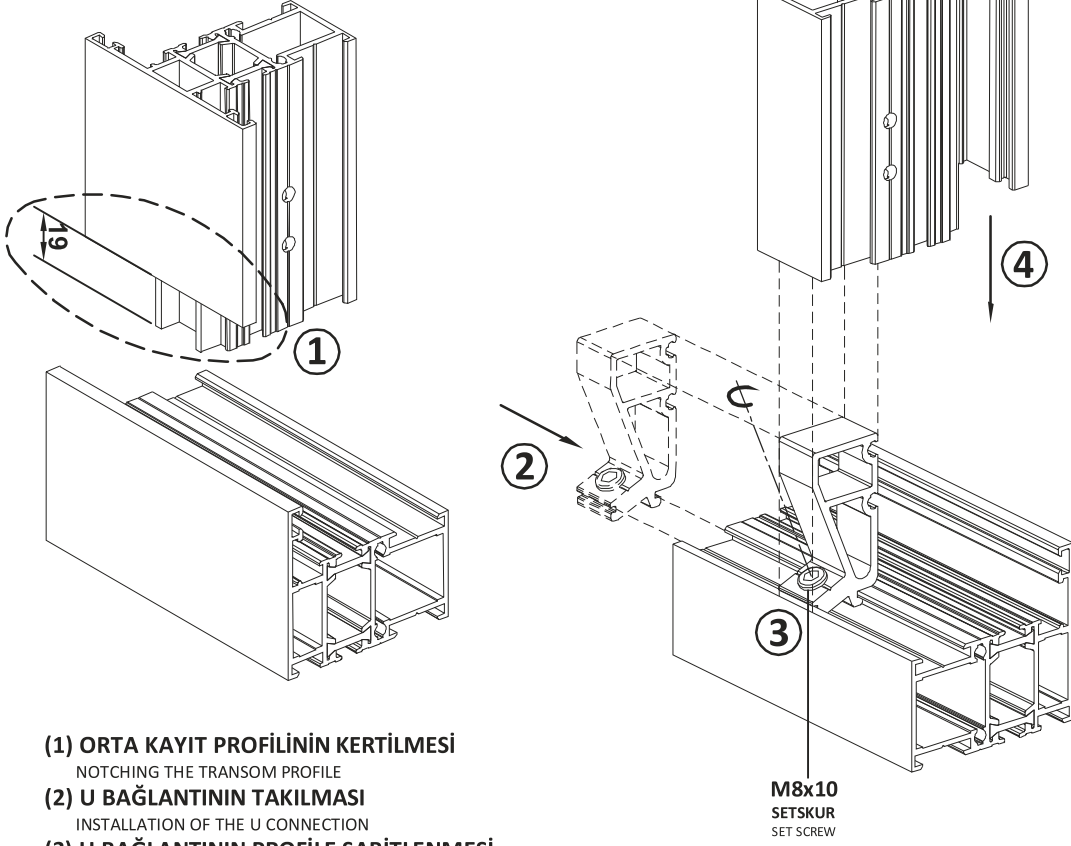

TABLO 1: GIESSE CLASSIC 3D ÇİFT AÇILIM SETLERİ
TABLE 1: GIESSE CLASSIC 3D TILT AND TURN OPENING KITS

SET KODU SET CODE	503001	503002	503003	503004
KANAT ENİ (W) KANAT YÜKS. (H) SASH WIDTH AND HEIGHT	W:350-389 H:600-1199	W:390-549 H:600-1199	W:550-999 H:600-1199	W:1000-1300 H:1200-2500
KOL CREMONE	613023	613023	613023	613023
MENTEŞE SETİ HINGES	513030	513030	513030	513030
MEKANİZMA MECHANISM	513027	513027	513027	513027
MAKAS ARM	513036	513037	513038	513038
İLAVE MAKAS ADDITIONAL ARM	-	-	-	513017
İLAVE KİLİTLEME ADDITIONAL FASTENING	-	-	-	513016

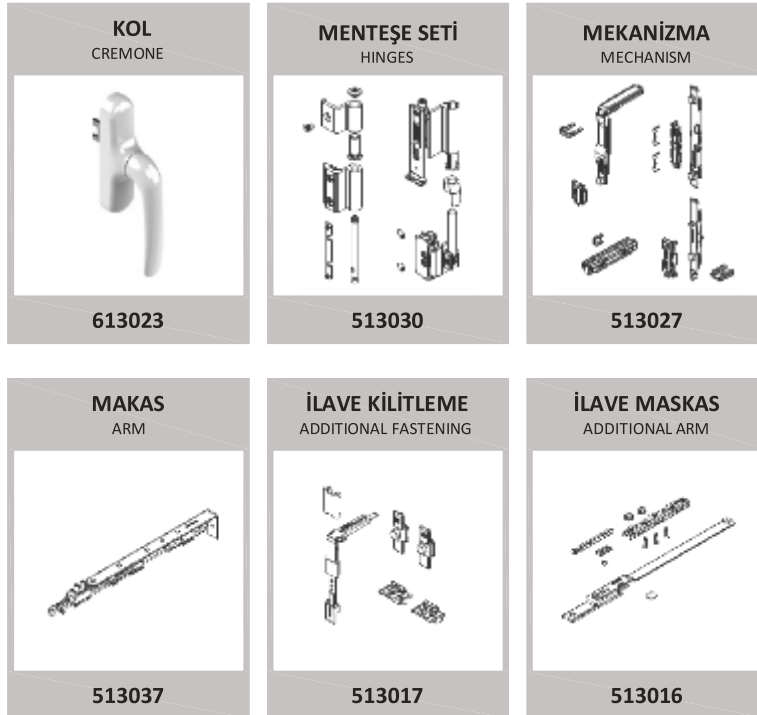
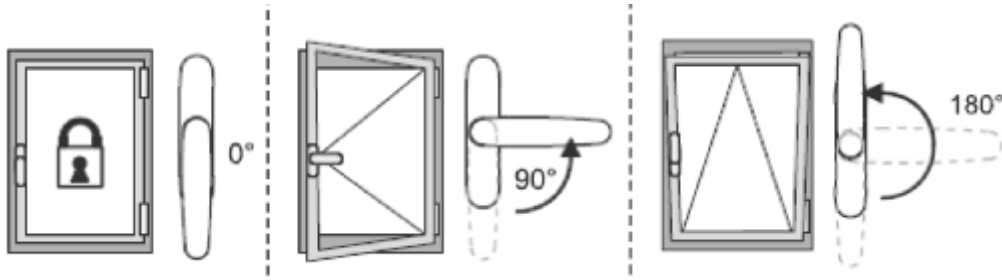

TABLO 2: GIESSE CLASSIC 3D AKILLI ÇİFT AÇILIM SETLERİ
TABLE 2: GIESSE CLASSIC 3D LOGICA TILT AND TURN OPENING SETS

SET KODU SET CODE	503005	503006
KANAT ENİ (W) KANAT YÜKS. (H) SASH WIDTH AND HEIGHT	W:390-999 H:600-1199	W:1000-1300 H:1200-2500
KOL CREMONE	613020	613020
MENTEŞE SETİ HINGES	513030	513030
MEKANİZMA MECHANISM	513028	513028
MAKAS ARM	513035	513029
İLAVE MAKAS ADDITIONAL ARM	-	513017
İLAVE KİLİTLEME ADDITIONAL FASTENING	-	513016

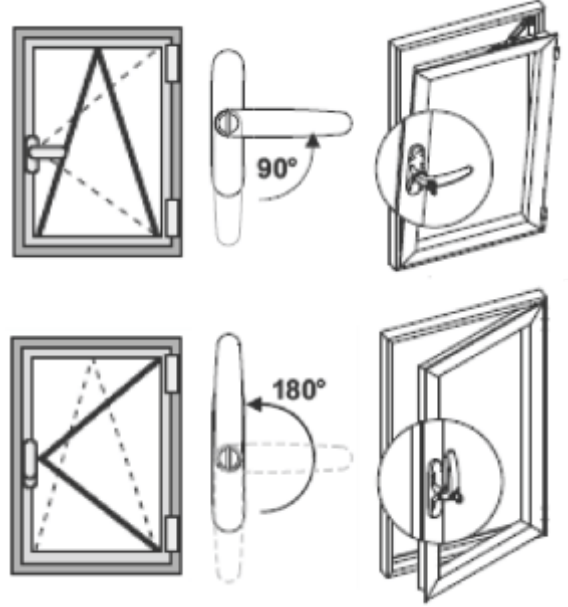

TABLO 3: G-U UNIJET PVC ÇİFT AÇILIM SETLERİ
TABLE 3: G-U UNIJET PVC TILT AND TURN OPENING SETS



SETİN İÇERİĞİ:
CONTENTS OF THE KIT:

- KOL
HANDLE
- MENTEŞELER
HINGES
- MAKASLAR
FRICTION HINGES
- İSPANYOLET TİJ
CONNECTION ROAD
- KİLİTLEME PARÇALARI
LOCKING PARTS

UNI-JET D MENTEŞE TİPİ / UNI-JET D HINGE TYPE

KANAT ENİ (W) KANAT YÜKS. (H) SASH WIDTH AND HEIGHT	SAĞA AÇILAN RIGHT HAND	SOLA AÇILAN LEFT HAND
SET KODU SET CODE	503008	503009

*KANAT MAKSİMUM 100 KG AĞIRLIĞINDA , GENİŞLİĞİ 501-1600 MM , YÜKSEKLİĞİ 951-2450 MM OLABİLİR.
 *MAX. CAPACITY OF EACH VENT: 100 KG , VENT WIDTH: 501-1600 MM , VENT HEIGHT: 951-2450 MM

TABLO 3: KANAT ÖLÇÜLERİNE GÖRE KİLİTLEME SETLERİ
TABLE 3: LOCKING KITS ACCORDING TO SASH DIMENSIONS

KOD CODE	ÜRÜN TANIMI PRODUCT DESCRIPTION	TEK MAÇALI KOL KİLİTLEME SETİ SINGLE RAIL HANDLE LOCKING KIT		ÇİFT MAÇALI KOL KİLİTLEME SETİ DOUBLE RAIL HANDLE LOCKING KIT	
		L<1000 H<1400	L>1000 H>1400	L<1000 H<1400	L>1000 H>1400
613011	ÇİFT MAÇALI KOL TWO-WAY CREMONE	-	-	1	1
613023	TEK MAÇALI KOL ONE-WAY CREMONE	1	1	-	-
643003	TEK MAÇALI KOL BAĞLANTISI ONE-WAY CREMONE CONNECTION	1	1	-	-
642003	ÇİFT MAÇALI KOL BAĞLANTISI TWO-WAY CREMONE CONNECTION	-	-	2	2
732002	KİLİTLEME PİMİ LOCKING PIN	2	4	2	4
732009	KARŞILIK STRIKER	3	5	3	5
732012	KANAT SARKMA TAKOZU CHOCK FOR VENTS	1	1	1	1
732003	KÖŞE İLETİM PARÇASI CORNER DEVICE	-	2	-	2



PARALEL SÜRME AKSESUSAR SETİ (543005)

PARALLEL SLIDE AND TILT KIT

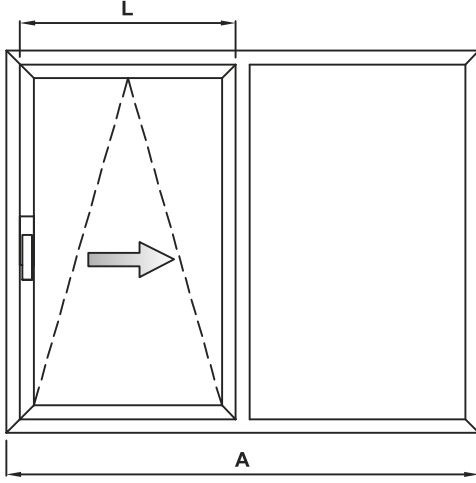

* SİPARİŞ VERİLİRKEN ŞU BİLGİLER GEREKMEKTEDİR:

- 1-ŞEMA TİPİ NEDİR? (AŞAĞIDAKİ ŞEMALARA BAKINIZ)
- 2-YANDA GÖRÜLEN H , L , A ÖLÇÜLERİ NEDİR?
- 3-KANAT AÇILIM YÖNÜNÜ İÇTEN BAKILDIĞINDA NEDİR?
- 4-DIŞ KOL İLE KİLİTLEME İSTENİYOR MU?
- 5-MEKANİZMA TAM MI YARI OTOMATİK Mİ OLACAK?

*WHEN TO ORDER, PLEASE INFORM US ABOUT THESE QUESTIONS:

- 1-WHAT IS THE SCHEME TYPE? (PLEASE LOOK BELOW SCHEME.)
- 2-WHAT ARE THESE H,L,A DIMENSIONS AS YOU CAN SEE ON LEFT SIDE?
- 3-WHAT IS THE INTERNAL OPENNING DIRECTION? (LEFT OR RIGHT)
- 4-DO YOU WANT OUTER HANDLE WITH LOCK?
- 5-WHETHER THE MECHANISM IS AUTOMATIC OR SEMI-AUTOMATIC.

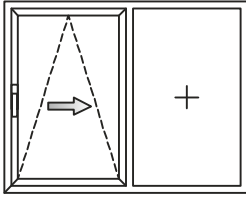

ŞEMA A

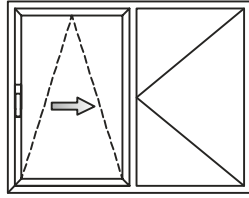

ŞEMA A2

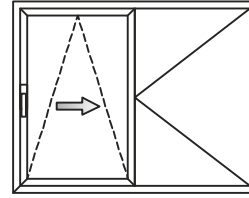

ŞEMA D (orta kayıtsız / without mullion)

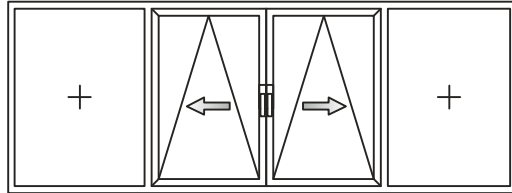

ŞEMA C

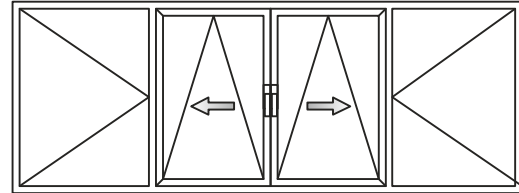

ŞEMA C2

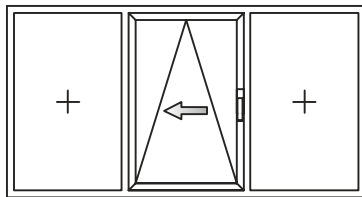

ŞEMA G

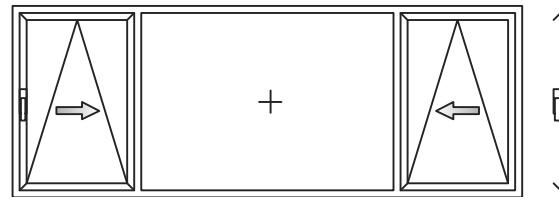

ŞEMA K

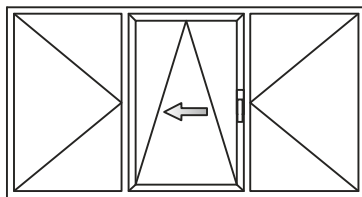

ŞEMA G2

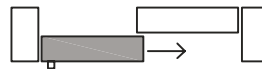

DİN YÖNÜ: SOL

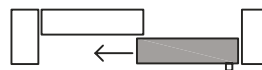

DİN YÖNÜ: SAĞ

KATLANIR KAPI VE PENCERE AKSESUAR SETİ (533004)

FOLDING DOOR&WINDOWS ACCESSORY KIT

CODE: 321 (1)

2 katlanır kanat,
1 çift açılım kanadı

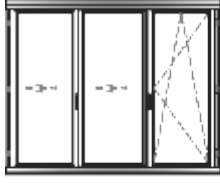

CODE: 541 (1)

4 katlanır kanat, 1 çift açılım kanadı



CODE: 651 (2)

4 katlanır kanat, 1 pasif tek açılım kanadı,
1 aktif çift açılım kanadı



CODE: 330

2 katlanır kanat,
1 tek açılım kanadı

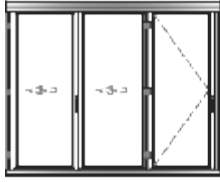

CODE: 550

4 katlanır kanat, 1 tek açılım kanadı



CODE: 633

4 katlanır kanat, 1 pasif tek açılım kanadı,
1 aktif tek açılım kanadı

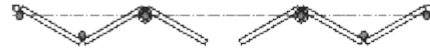
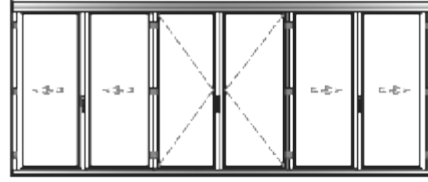

CODE: 431

2 katlanır , 1 pasif tek açılım,
1 aktif çift açılım kanat

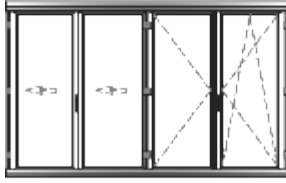

CODE: 532

4 katlanır kanat, 1 tek açılım kanadı

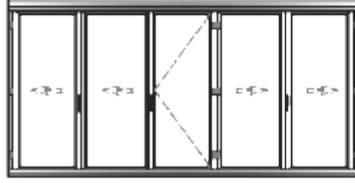

CODE: 761 (1)

6 katlanır kanat, 1 çift açılım kanadı



CODE: 743

6 katlanır kanat, 1 tek açılım kanadı

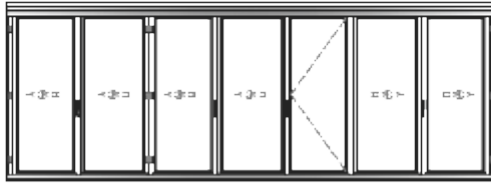

CODE: 770

6 katlanır kanat, 1 tek açılım kanadı



*KANATLAR MAKSİMUM 80 KG AĞIRLIĞINDA , GENİŞLİKLERİ 400-1000 MM , YÜKSEKLİKLERİ 730-2400 MM ARALIĞINDA YAPILABİLİR. GEÇİŞ KANADI İSTEĞE GÖRE TEK VEYA ÇİFT AÇILIM YAPILABİLİR.

*MAX. CAPACITY OF EACH VENT: 80 KG , VENT WIDTH: 400-1000 MM , VENT HEIGHT: 730-2400 MM
THE GATE VENT CAN BE PRODUCED SIDE HUNG OR TILT AND TURN OPENING AS YOUR CHOICE.

*SİPARİŞ VERİLİRKEN ŞU BİLGİLER GEREKMEKTEDİR / WHEN TO ORDER, PLEASE INFORM US ABOUT THESE QUESTIONS:

1-ŞEMA TİPİ NEDİR? / WHAT IS THE SCHEME TYPE?

2-KANAT VE DOĞRAMA ÖLÇÜLERİ NEDİR? / VENT AND FRAME DIMENSIONS AS YOU CAN SEE ON LEFT SIDE?

3-KANAT AÇILIM YÖNÜNÜ İÇTEN BAKILDIĞINDA NEDİR? / WHAT IS THE INTERNAL OPENING DIRECTION?

4-DIŞ KOL İLE KİLİTLEME İSTENİYOR MU? / DO YOU WANT OUTER HANDLE WITH LOCK?

5-MEKANİZMA EŞİKLİ Mİ EŞİKSİZ Mİ OLACAK? / WHETHER THE MECHANISM IS WITH OR WITHOUT THRESHOLD.

KAPI MENTEŞESİ BAĞLANTI DETAYLARI

CONNECTION DETAILS OF THE DOOR HINGES

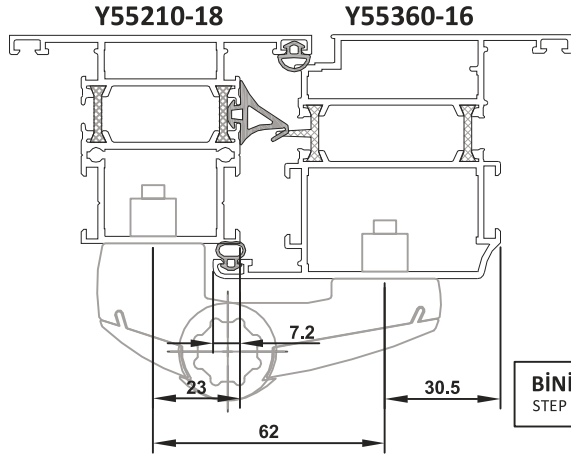
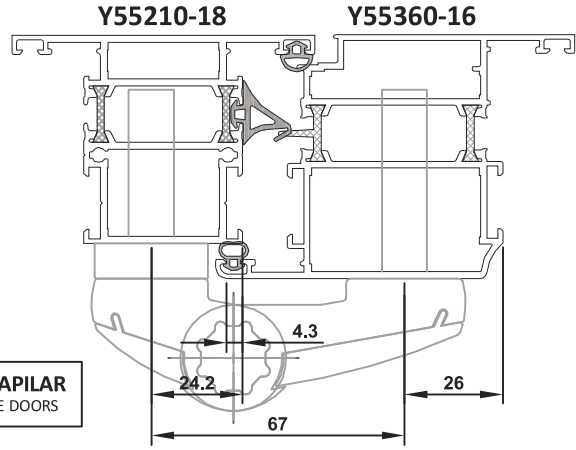
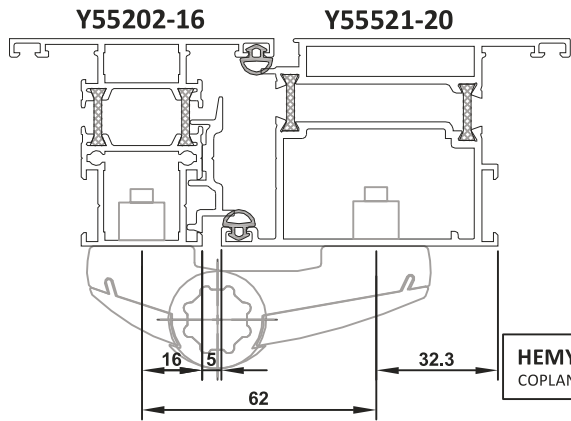
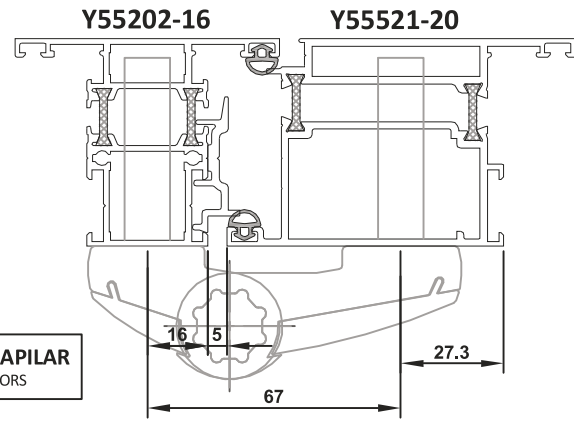
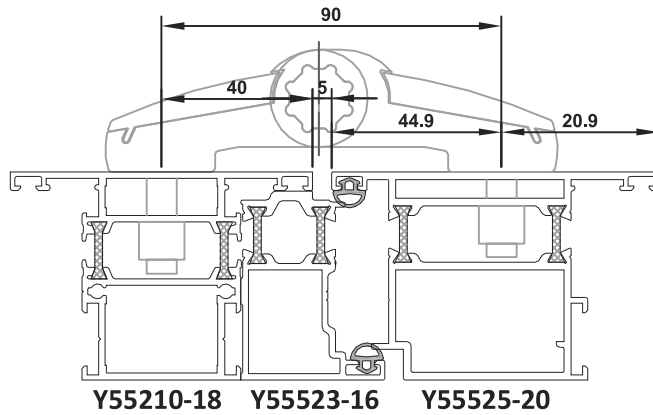
423006 & 423010**422016****BİNİLİ KAPILAR**
STEP HINGE DOORS**423006****422015****HEMYÜZ KAPILAR**
COPLANAR DOORS**422021**

Y55210-18 Y55523-16 Y55525-20

KAPI KİLİTLEME SETLERİ

DOOR LOCKING KITS

BİNİLİ KAPILAR / STEP HINGE DOORS

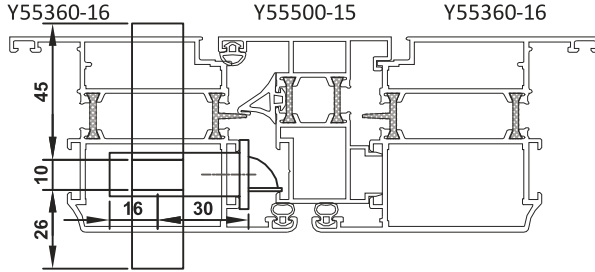

İÇE AÇILIR KAPI / INWARD OPENING DOOR

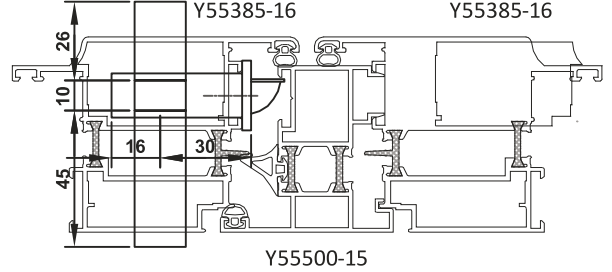

DIŞA AÇILIR KAPI / OUTWARD OPENING DOOR

HEMYÜZ KAPILAR / FLUSH DOORS

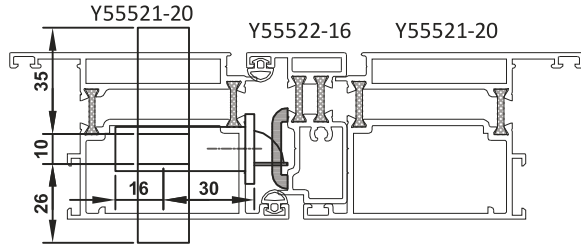

İÇE AÇILIR KAPI / INWARD OPENING DOOR

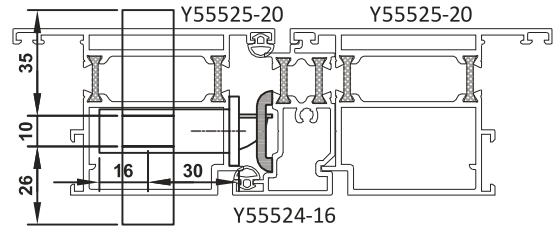

DIŞA AÇILIR KAPI / OUTWARD OPENING DOOR

TABLO 4: KAPI KİLİTLEME TÜRLERİ

TABLE 4: DOOR LOCKING TYPES

	KİLİT MEKANİZMASI LOCKING MECHANISM	KİLİT KARŞILIĞI STRIKER
DİLLİ KİLİT LOCK WITH RAIL	712009	732008
MAKARALI KİLİT LOCK WITH ROLLER	712015	732020

TABLO 5: BARELLER

TABLE 5: CYLINDERS

	BAREL CYLINDER
BİNİLİ KAPI STEP HINGE DOOR	722038
HEMYÜZ KAPI FLUSH DOOR	722039

KALE 153U DİLLİ KİLİT
LOCK WITH RAIL**712009****KALE 155U MAKARALI KİLİT**
LOCK WITH ROLLER**712015****KALE 164 SNC BAREL (71 MM)**
71 MM CYLINDER**722038****KALE 164 SNC BAREL (81 MM)**
81 MM CYLINDER**722039****DİLLİ KİLİT KARŞILIĞI**
STRIKER FOR LOCK WITH RAIL**732008****MAKARALI KİLİT KARŞILIĞI**
STRIKER FOR LOCK WITH ROLLER**732020**

KAPI KİLİTLEME SETİ

DOOR LOCKING KIT



**TABLO 6: BİNİLİ KAPILAR İÇİN
İÇTEN VE DIŞTAN MÜDAHELELİ KİLİT**
TABLE 6: INWARD & OUTWARD INTERFERENCED
LOCK FOR STEP HINGE DOORS

KOD	ÜRÜN
762001	KİLİT MEKANİZMASI / LOCKING MECHANISM
732008	KİLİT KARŞILIĞI / STRIKER FOR MORTISE LOCK
732003	KÖŞE İLETİM PARÇASI / CORNER DEVICE
732002	KARŞILIK / STRIKER
732009	KİLİTLEME PİMİ / LOCKING PIN

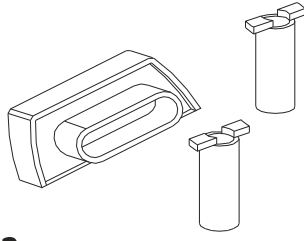
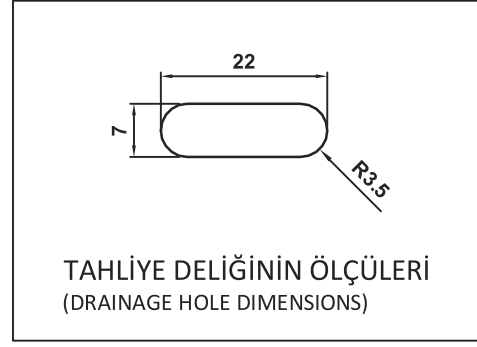
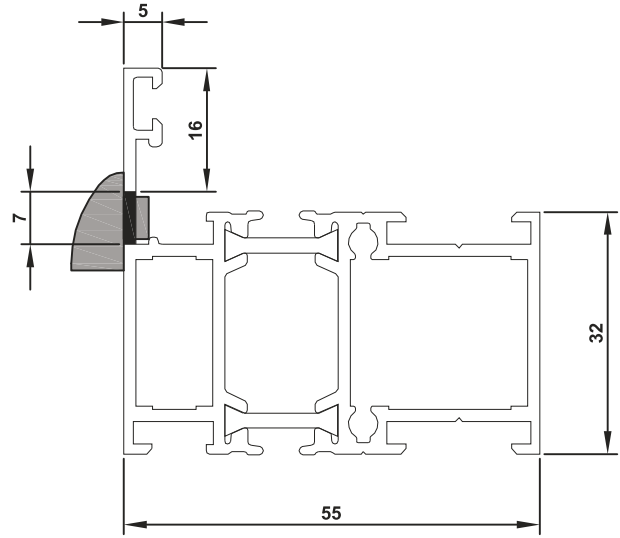
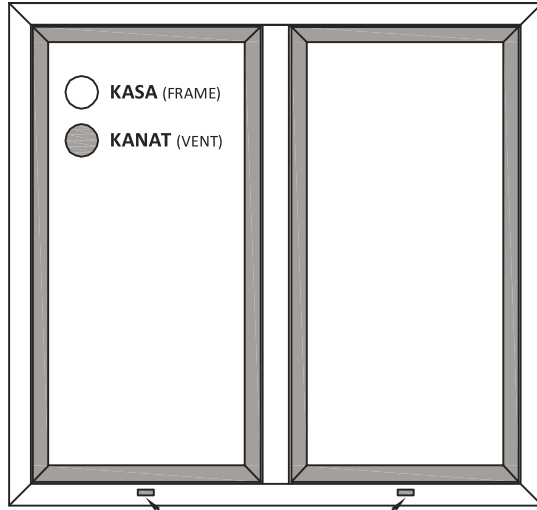
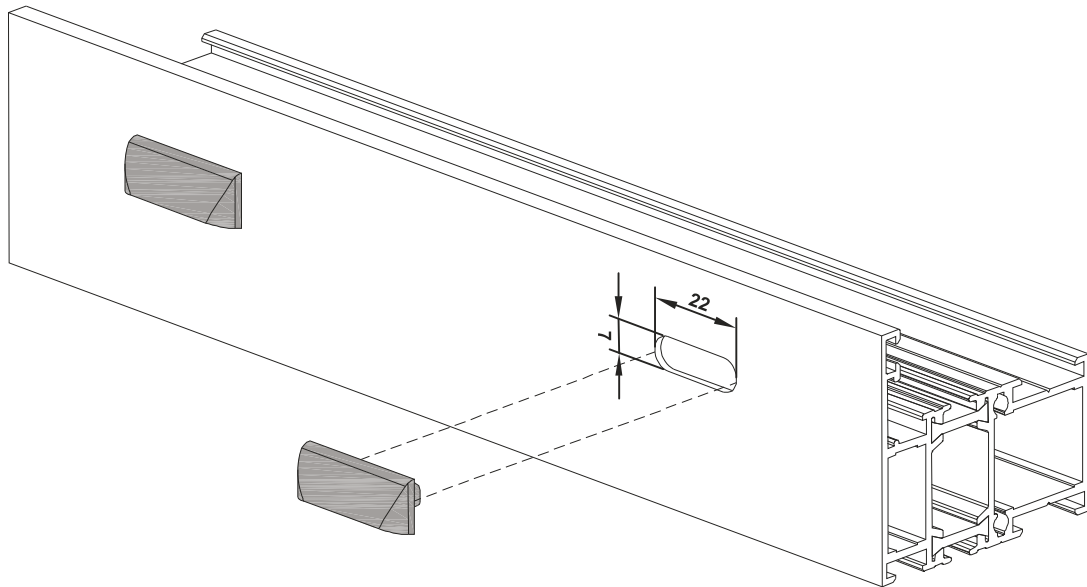
**322022****TAHLİYE KAPAĞI**
DRAINAGE SLOT COVER**DIŞ GÖRÜNÜŞ**
(OUTSIDE VIEW)**TAHLİYE KAPAKLARI**
(DRAINAGE SLOT COVERS)

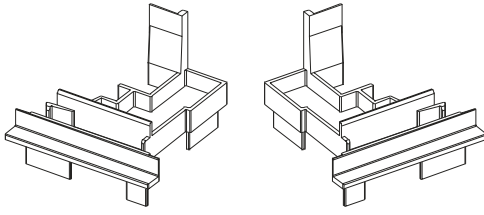
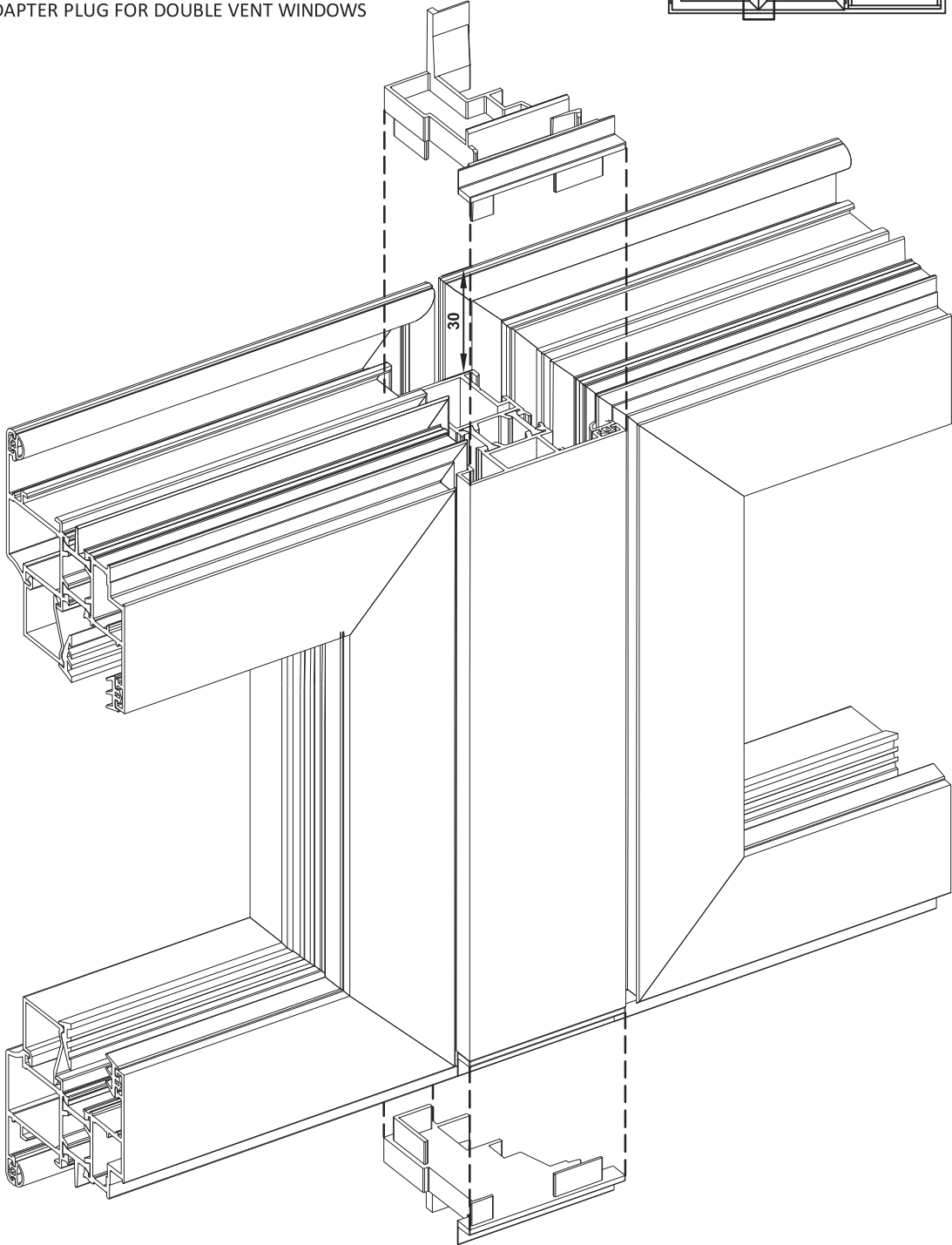
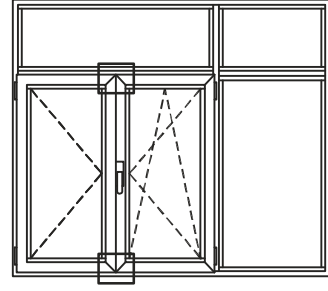
**332045****ÇİFT KANAT ORTA ADAPTÖR TAPASI**
ADAPTER PLUG FOR DOUBLE VENT WINDOWS

175

**GIESSE FLASH BASE
PENCERE MENTEŞESİ**

GIESSE FLASH BASE WINDOW HINGE

*KAPASİTE: 75 KG
*CAPACITY: 75 KG**413004****GIESSE BRIDGE 2 MENTEŞE**

GIESSE BRIDGE 2 HINGE

*KAPASİTESİ: 90 KG
*CAPACITY: 90 KG**423003****GIESSE FLASH XL KAPI MENTEŞESİ**

GIESSE FLASH XL DOOR HINGE

*KAPASİTESİ: 100 KG
*CAPACITY: 100 KG**423004****GIESSE DOMINA HP 62,5MM**

KAPI MENTEŞESİ

GIESSE DOMINA HP DOOR HINGE

*KAPASİTESİ: 160 KG
*CAPACITY: 160 KG**423005****GIESSE DOMINA CLASSIC 62,5MM**

KAPI MENTEŞESİ

GIESSE DOMINA CLASSIC DOOR HINGE

*KAPASİTESİ: 120 KG
*CAPACITY: 120 KG**423006****GIESSE DOMINA HP 78MM**

KAPI MENTEŞESİ

GIESSE DOMINA HP DOOR HINGE

*DIŞA AÇILIR HEMYÜZ KAPI İÇİNDİR.
*FOR OUTWARD OPENING COPLANAR DOOR.**423012****GIESSE DOMINA CLASSIC 78MM**

KAPI MENTEŞESİ

GIESSE DOMINA CLASSIC DOOR HINGE

*DIŞA AÇILIR HEMYÜZ KAPI İÇİNDİR.
*FOR OUTWARD OPENING COPLANAR DOOR.**423013****GIESSE DOMINA MENTEŞE**

MONTAJ KİTİ

GIESSE DOMINA HINGE COUNTERPLATE KIT

**423007****GIESSE DOMINA MENTEŞE**

M12x55 BAĞLANTI VİDASI

GIESSE DIRECT SCREW FOR DOMINA HINGES

*1 MENTEŞEDE 4 ADET KULLANILIR.
*IT IS USED 4 PIECES PER 1 DOMINA HINGE.**423008**

GIESSE DOMINA MENTEŞE
TELESKOPİK BAĞLANTI VİDASI
TELESCOPIC SPACER FOR OUTWARD OPENING



*DIŞA AÇILIMDA 1 MENTEŞEDE
4 ADET KULLANILIR.
* IT IS USED 4 PIECES PER 1 HINGE IN OUTWARD
OPENING.

423009

GIESSE DOMINA MENTEŞE
10MM BURÇLU BİNİ PARÇASI
GIESSE DOMINA STEP 10 WITH BUSHES

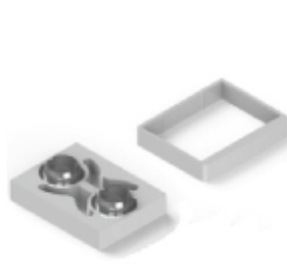

*423007 İLE KULLANILIR.
* IT IS USED WITH 423007.

423010

GIESSE DOMINA MENTEŞE
10MM BİNİ PARÇASI
GIESSE DOMINA STEP 10 WITHOUT BUSHES



*423008 İLE KULLANILIR.
* IT IS USED WITH 423008.

423011

GIESSE FRIBLOK PİVOT MENTEŞE
GIESSE FRIBLOK PIVOT HINGE



413005

BURAK SİSTEM PENCERE MENTEŞESİ
BURAK SYSTEM WINDOW HINGE



411002

PENCERE MENTEŞESİ
WINDOW HINGE



412008

PENCERE MENTEŞESİ
WINDOW HINGE



412013

HEMYÜZ KAPI MENTEŞESİ
HINGE FOR COPLANAR DOORS



422015

BİNİLİ KAPI MENTEŞESİ
STEP HINGE FOR DOORS

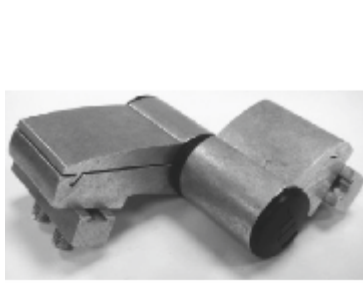

422016

HEMYÜZ KAPI MENTEŞESİ
HINGE FOR FLUSH DOORS**422019****BİNLİ KAPI MENTEŞESİ**
STEP HINGE FOR DOORS**422020****DIŞA AÇILIR HEMYÜZ KAPI MENTEŞESİ**
OUTWARD OPENING HINGE FOR FLUSH DOORS**422021****AYARLI KAPI MENTEŞESİ**
ADJUSTABLE DOOR HINGE**422012****BURAK SİSTEM KAPI MENTEŞESİ**
BURAK SYSTEM DOOR HINGE**421001****ÇARPMA KAPI MENTEŞESİ**
SWINGING DOOR HINGE**422009****PİVOT MENTEŞE**
PIVOT HINGE**412010**

GIESSE EURO ÇİFT MAÇALI KOL
GIESSE EURO TWO-WAY CREMONE



613008

GIESSE EURO TEK MAÇALI KOL
GIESSE EURO ONE-WAY CREMONE



613022

GIESSE PRIMA ÇİFT MAÇALI KOL
GIESSE PRIMA TWO-WAY CREMONE



613011

GIESSE PRIMA ÇİFT MAÇALI ANAHTARLI KOL
GIESSE PRIMA TWO-WAY CREMONE WITH KEY



613012

GIESSE PRIMA TEK MAÇALI KOL
GIESSE PRIMA ONE-WAY CREMONE



613023

GIESSE PRIMA TEK MAÇALI ANAHTARLI KOL
GIESSE PRIMA ONE-WAY CREMONE WITH KEY



613024

GIESSE UNICA ÇİFT MAÇALI KOL
GIESSE UNICA TWO-WAY CREMONE



613013

GIESSE UNICA ÇİFT MAÇALI ANAHTARLI KOL
GIESSE UNICA TWO-WAY CREMONE WITH KEY



613014

GIESSE UNICA TEK MAÇALI KOL
GIESSE UNICA ONE-WAY CREMONE



613027

GIESSE ASIA ÇİFT MAÇALI KOL
GIESSE ASIA TWO-WAY CREMONE**613015****GIESSE ASIA ÇİFT MAÇALI ANAHTARLI KOL**
GIESSE ASIA TWO-WAY CREMONE WITH KEY**613016****GIESSE ASIA TEK MAÇALI KOL**
GIESSE ASIA ONE-WAY CREMONE**613025****GIESSE ASIA AKILLI ÇİFT AÇILIM KOLU**
GIESSE ASIA ONE-WAY CREMONE LOR LOGICAL
TILT&TURN MECHANISM**613026****GIESSE TREND ÇİFT MAÇALI KOL**
GIESSE TREND TWO-WAY CREMONE***KROM KAPLAMALI PİRİNÇ GÖVDE**
CHROME PLATED BRASS BODY*613018****GIESSE TREND TEK MAÇALI KOL**
GIESSE TREND ONE-WAY CREMONE**613028****GIESSE EURO SÖKÜLEBİLİR KOL**
GIESSE EURO AWAY CREMONE**613004****GIESSE EURO SÖKÜLEBİLİR KOL SAPI**
GIESSE PULL HANDLE FOR EURO AWAY**613005****GIESSE UNICA SÖKÜLEBİLİR KOL**
GIESSE UNICA AWAY CREMONE**613029**

GIESSE UNICA SÖKÜLEBİLİR KOL SAPI
GIESSE PULL HANDLE FOR UNICA AWAY



613030

GIESSE ASIA SÖKÜLEBİLİR KOL
GIESSE ASIA AWAY CREMONE



613017

GIESSE ASIA SÖKÜLEBİLİR KOL SAPI
GIESSE ASIA AWAY CREMONE



613021

GIESSE PRIMA KAPI KOLU
GIESSE PRIMA DOOR HANDLE



623002

GIESSE PRIMA BAREL ROZETİ
GIESSE CYLINDER COVER PLATE



623005

GIESSE SUPERMASTER KAPI KOLU
GIESSE SUPERMASTER DOOR HANDLE



623003

GIESSE SUPERMASTER BAREL ROZETİ
GIESSE CYLINDER COVER PLATE



623006

GIESSE FLORA KAPI KOLU
GIESSE FLORA DOOR HANDLE



623004

GIESSE FLORA BAREL ROZETİ
GIESSE CYLINDER COVER PLATE

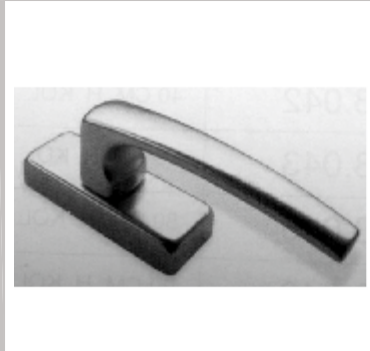

623007

ÇİFT MAÇALI EKSENEL KOL
CREMONE HANDLE**612018****ÇİFT MAÇALI SÖKÜLEBİLİR KOL**
GRIP HANDLE**612016****ÇİFT MAÇALI SÖKÜLEBİLİR KOL SAPI**
PULL HANDLE FOR 612016**612017****ÇİFT MAÇALI EKSENEL KOL**
TWO WAY CREMONE**612013****KAPI KOLU**
DOOR HANDLE**622134****KAPI KOLU**
DOOR HANDLE**622135****BAREL ROZETİ**
CYLINDER COVER PLATE**622136****KAPI KOLU**
DOOR HANDLE**622125****BAREL ROZETİ**
CYLINDER COVER PLATE**622130**

GIESSE RALLENTY VASİSTAS MAKAS
GIESSE RALLENTY ARM FOR BOTTOM-HUNG
150 MM



453001

GIESSE RALLENTY VASİSTAS MAKAS
GIESSE RALLENTY ARM FOR BOTTOM-HUNG
250 MM



453002

GIESSE TWIN VASİSTAS MANDALI
GIESSE TWIN CATCH



753006

GIESSE GRISBI VASİSTAS MANDALI
GIESSE GRISBI CATCH



753007

VASİSTAS MAKAS
ARM FOR BOTTOM-HUNG WINDOW



452004

ALÜMİNYUM VASİSTAS MAKAS
ARM FOR BOTTOM-HUNG WINDOW



452005

VASİSTAS MANDALI
CATCH FOR BOTTOM-HUNG WINDOW



752005

VASİSTAS MANDALI
CATCH FOR BOTTOM-HUNG WINDOW

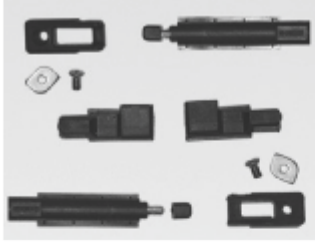
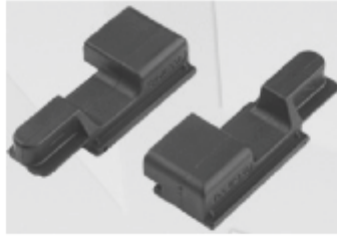
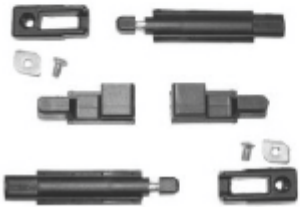

752002

**GIESSE ÇİFT MAÇALI KOL İLE
KİLİTLEME SETİ**
GIESSE KIT FOR TWO-WAY SASH CLOSING**773001****GIESSE AYARLI PİM**
GIESSE ADJUSTABLE FASTENING PAWL**733002****GIESSE SABİT KARŞILIK**
GIESSE FIXED STRIKER**733009****GIESSE KÖŞE İLETİM PARÇASI**
GIESSE CORNER DEVICE**733003****GIESSE ÇİFT MAÇALI KOL BAĞLANTISI**
GIESSE TWO-WAY DRIVE ROD COMPONENTS**643004****GIESSE TEK MAÇALI KOL BAĞLANTISI**
GIESSE PULL DEVICE FOR ONE-WAY CREMONES**643003****ÇİFT MAÇALI KOL İLE KİLİTLEME SETİ**
LOCKING KIT FOR TWO-WAY CREMONE**772001****AYARLI KİLİTLEME PİMİ**
ADJUSTABLE FASTENING PAWL**732002**

SABİT KARŞILIK
FIXED STRIKER



732009

AYARLI KARŞILIK
ADJUSTABLE STRIKER



732007

KÖŞE İLETİM PARÇASI
CORNER DEVICE



732003

ÇİFT MAÇALI KOL BAĞLANTILARI
TWO-WAY DRIVE ROD COMPONENTS



642003

PENCERE SÜRGÜSÜ
WINDOW BOLT



742002

GIESSE 2. KANAT İÇİN SÜRGÜ
GIESSE TWO-WAY LEVER BOLT



743001

KANAT SARMA TAKOZU
CHOCK FOR VENTS

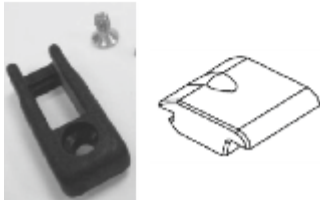

732012

KAPI SÜRGÜSÜ
DOOR BOLT



742001

PANİK BAR
PANIC DEVICE**572001****ÇİFT KANAT PANİK BAR**
PANIC DEVICE FOR DOUBLE SASH**572003****PANİK ÇIKIŞ İÇİN DİŞ KOL**
OUTER HANDLE FOR PANIC DEVICE**572005****KALE KAPI KAPATICI 3**
KALE DOOR CLOSER 3**562002****KALE KAPI KAPATICI 4**
KALE DOOR CLOSER 4**562003****KALE KAYAR KOLLU KAPI KAPATICI 3**
KALE DOOR CLOSER WITH SLIDING ARM**562004****KALE KAYAR KOLLU KAPI KAPATICI 4**
KALE DOOR CLOSER WITH SLIDING ARM**562005**

GIESE GHIBO OUT KOL MEKANİZMASI
GIESE GHIBO OUT TWO-WAY MECHANISM
FOR OUTWARD OPENING



643005

GIESE PRIMA PENCERE KOLU
GIESE PRIMA WINDOW HANDLE



613031

ÇİFT KANAT ADAPTÖR TAPASI
ADAPTER PLUG FOR DOUBLE VENTS

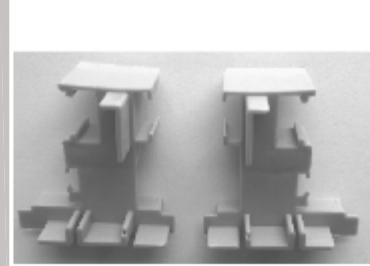

332045

TAHLİYE KAPAĞI
DRAINAGE SLOT COVER



322022

GIESE POLYAMİD TİJ
GIESE POLYAMIDE CONNECTION ROD



733007

**GIESE MANUEL TİJ
KESME-DELME MAKİNESİ**
GIESE ROD CUTTING AND DRILLING MACHINE



943086

**GIESE YARI OTOMATİK TİJ
KESME-DELME MAKİNESİ**
GIESE ROD CUTTING AND DRILLING MACHINE



943087

YALITIM MALZEMELERİ

INSULATION MATERIALS

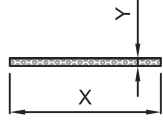

POLİETİLEN BANT		
POLYETILEN BAND		
	X (mm)	Y (mm)
922001	50	2
922002	60	2
922003	70	2
922004	80	2
922005	90	2
922006	100	2



FOİL BANT		
FOIL BAND		
	X (mm)	Y (mm)
922020	40	1
922021	45	1
922022	50	1
922023	55	1
922024	60	1
922025	65	1
922026	70	1
922027	75	1
922028	80	1
922029	85	1
922030	90	1
922031	95	1
922032	100	1
922033	150	1

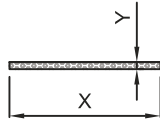

TEK TARAF LI BANT		
SINGLE-SIDE STICK		
	X (mm)	Y (mm)
922009	10	1,5
922010	15	1,5
922011	20	1,5
922012	25	1,5
922013	30	1,5
922014	40	1,5
922015	10	3
922016	15	3
922017	20	3
922018	25	3
922019	40	3

ÇİFT TARAF LI BANT

DOUBLE-SIDE STICK

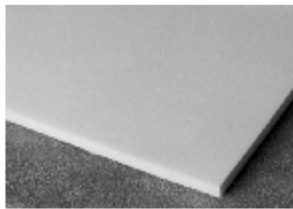

923006

EPDM MEMBRAN

INSULATION MEBRANE

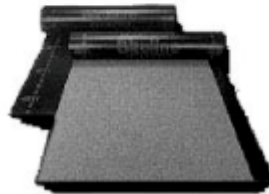

923009

PVC MEMBRAN

INSULATION MEBRANE

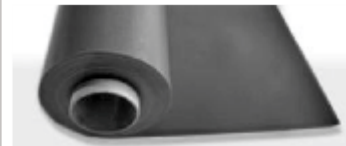

923010

KULLANIM ŞARTLARI

Profiller, folyolu muhafaza edilmeli, folyoları inşaat bitiminde çıkartılmalıdır. Kireç ve çimento gibi inşaat malzemeleri alüminyum yüzeylerle temas etmemelidir.

Profiller binaya uygulandıktan sonra düzenli aralıklarla temizlenmelidir. Profillerin temizliği, hafifçe sabunlu ılık su ve/veya bu suyla ıslatılmış yumuşak bir bez ile yapılmalı, deterjan, çamaşır suyu, zımpara, tel fırça ve aşındırıcı, alkali, asidik temizleyici kullanılmamalıdır.

Sistem için önerilen aksesuar ve sarf malzemeleri katalogda belirtilen biçimde uygulanmalı ve tüm aksesuarları eksiksiz olarak kullanılmalıdır.

Sistemin katalogda belirtilen fitilleme, silikonlama, su tahliyesi ve havalandırma metodlarına uyulmalıdır. İlave her türlü uygulama için Burak Alüminyum'dan destek ve onay alınmalıdır.

GARANTİ KOŞULLARI

Profiller, yukarıda belirtilen şartlara uygun biçimde kullanılmış ve hiçbir şekilde mekanik hasara veya deformasyona uğramamış ise, herhangi bir kusur durumunda, garantimiz yalnız kusurlu parçaların de-montajı, tekrar üretimi, tekrar eloksali ve tekrar yerine takılması ile sınırlı olacaktır. Yukarıda bahsedilmeyen konular iş hukukuna tabidir.

Mimari sistem kataloğunda belirtilmeyen veya Burak Alüminyum'un onay vermediği aksesuar ve sarf malzemesi kullanımından doğabilecek her türlü sorumluluk uygulamacı firmaya aittir.

Mimari sistem kataloğunda belirtilen detay ve sistem çözümleri haricindeki uygulamalar için Burak Alüminyum'un onayı alınmalıdır. Aksi takdirde bu uygulamalardan meydana gelebilecek problem ve aksaklıklardan Burak Alüminyum sorumlu değildir.

TERMS OF SERVICE

Profiles must be protected with folio tapes and they must be taken out when the structure was finished. Building materials as similar lime and cement must not be touched with the aluminium surfaces.

The profiles must be cleaned periodically after the structure was finished. Cleaning of profiles must be done by the fabric that was damped with warm water and soap. Don't use detergent, chlorine water, emery, wire brush, abrasive, base, acidic cleaner.

Accessories and consumables should be applied as shown at the catalogue and used completely.

Glazing, siliconing, water drainage and ventilation methods specified on the catalogue should be applied completely. Any type of the additional methods should be approved by Burak Aluminium.

TERMS OF WARRANTY

If the profiles was used according to terms of service and they have no mechanical damage or deformation, in any defect situation, our warranty is limited by disassembly, re-product, re-eloxal, re-assembly of faulty pieces. These are subjected to labor law.

Builder is responsible for all conditions by using of accessories and consumables that did not confirmed by Burak Aluminium are not mentioned in catalogue of Architectural System.

Confirmation must be taken from Burak Aluminium for applications without details and system solutions that are mentioned in catalogue of architectural sytem. If not Burak Aluminium is not responsible because of any wrong applications.



CERTIFICATE



TÜRKAKREDIT

BURAK ALÜMİNYUM SANAYİ VE TİCARET A.Ş.

ULUSAL ALÜMİNYUM SANAYİ VE TİCARET A.Ş.
BÜYÜKSAĞIRCI RAYI LOLESBURGAZ 34030 KÜLTÜRLEJ
T.C. BURSA

For and on behalf of Quality Management System

Şirketin Burak Alüminyum Sanayi ve Ticaret A.Ş. bünyesinde bulunan ve faaliyet alanı olan Alüminyum Üretim ve Ticaret İşletim Sistemi için ISO 9001:2008 standardına uygun olarak sertifikasyon yapılmıştır.

An audit was carried out in accordance with the requirements of the ISO 9001:2008 standard and the company has been found to be in compliance with the requirements of the standard.

ISO/TS 18949 : 2009

without additional scope



Certification version 2014-09-11
The certificate is valid until 2017-09-10
Certification Regulation No. 21300066 TEBSD
MÜTİM
Firma Adı: BURAK ALÜMİNYUM SANAYİ VE TİCARET A.Ş.
Firma Adı: BURAK ALÜMİNYUM SANAYİ VE TİCARET A.Ş.

For and on behalf of DQS GmbH

G. Blocher

www.dqs.com
DQS GmbH
DQS Center

DQS Center DQS GmbH, Rajahmundry 520010, India. Tel: +91 886 801 0101



SERTİFİKA



BURAK ALÜMİNYUM SANAYİ VE TİCARET A.Ş.

ULUSAL ALÜMİNYUM SANAYİ VE TİCARET A.Ş.
BÜYÜKSAĞIRCI RAYI LOLESBURGAZ 34030 KÜLTÜRLEJ
T.C. BURSA

Şirketin Burak Alüminyum Sanayi ve Ticaret A.Ş. bünyesinde bulunan ve faaliyet alanı olan Alüminyum Üretim ve Ticaret İşletim Sistemi için ISO 9001:2008 standardına uygun olarak sertifikasyon yapılmıştır.

Şirketin Burak Alüminyum Sanayi ve Ticaret A.Ş. bünyesinde bulunan ve faaliyet alanı olan Alüminyum Üretim ve Ticaret İşletim Sistemi için ISO 9001:2008 standardına uygun olarak sertifikasyon yapılmıştır.

An audit was carried out in accordance with the requirements of the ISO 9001:2008 standard and the company has been found to be in compliance with the requirements of the standard.

ISO/TS 18949 : 2009

without additional scope



Certification version 2014-09-11
The certificate is valid until 2017-09-10
Certification Regulation No. 21300066 TEBSD
MÜTİM
Firma Adı: BURAK ALÜMİNYUM SANAYİ VE TİCARET A.Ş.
Firma Adı: BURAK ALÜMİNYUM SANAYİ VE TİCARET A.Ş.

For and on behalf of DQS GmbH

G. Blocher

www.dqs.com
DQS GmbH
DQS Center

DQS Center DQS GmbH, Rajahmundry 520010, India. Tel: +91 886 801 0101



CERTIFICATE



This is certifi that

BURAK ALÜMİNYUM SAN VE TIC. A.Ş
 BURAK ALUMINIUM SAN. VE TIC. A.Ş
 BURAK ALUMINIUM SAN. VE TIC. A.Ş
 BURAK ALUMINIUM SAN. VE TIC. A.Ş

Occupational Health and Safety Management System

SCOPE
 Alüminyum üretim tesisleri için işyeri sağlık ve güvenliği yönetim sistemi

Through a set of documents in a model, Burak ve filial tesisleri için işyeri sağlık ve güvenliği yönetim sistemi

BS OHSAS 18001 : 2007

Certificate registration no: 01000096
 Valid from: 2014-06-02
 Valid until: 2017-06-01
 Date of certification: 2014-06-02



DQS GmbH

G. Blocher

SEITE 2009/01
 01.01.2015

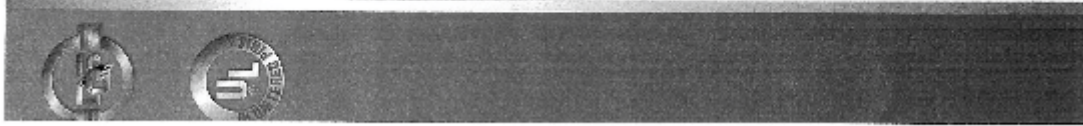

SERTİFİKA



BURAK ALÜMİNYUM SAN VE TIC. A.Ş
 BURAK ALUMINIUM SAN. VE TIC. A.Ş
 BURAK ALUMINIUM SAN. VE TIC. A.Ş
 BURAK ALUMINIUM SAN. VE TIC. A.Ş

İşyeri Sağlık ve Güvenliği Yönetim Sistemi

SCOPE
 Alüminyum üretim tesisleri için işyeri sağlık ve güvenliği yönetim sistemi

Through a set of documents in a model, Burak ve filial tesisleri için işyeri sağlık ve güvenliği yönetim sistemi

BS OHSAS 18001 : 2007

Certificate registration no: 21300068
 Valid from: 2014-06-02
 Valid until: 2017-06-01
 Date of certification: 2014-06-02



DQS GmbH

G. Blocher

SEITE 2009/01
 01.01.2015



CERTIFICATE



This is certificate:

BURAK ALÜMİNYUM SAN VE TIC. A.Ş.
 İZMİR ÜBEREMENKİ KURATLI YOLU 3. KAT.
 BURAK ALÜMİNYUM SAN VE TIC. A.Ş.
 BURAK ALÜMİNYUM SAN VE TIC. A.Ş.

ISO 14001 : 2004 + Cor 1 : 2009

Standard : ISO 14001 : 2004 + Cor 1 : 2009

Through a visit, documented in a report, I was satisfied that the management system of the client complies with the requirements of the standard.

ISO 14001 : 2004 + Cor 1 : 2009

Certificate registration no. : 21101063
 Valid from : 2014-05-02
 Valid until : 2017-05-02
 Date of certification : 2014-05-02



DCS GmbH

G. Blachschmidt
 G. Blachschmidt
 Geschäftsführer



SERTİFİKA



BURAK ALÜMİNYUM SAN VE TIC. A.Ş.
 İZMİR ÜBEREMENKİ KURATLI YOLU 3. KAT.
 BURAK ALÜMİNYUM SAN VE TIC. A.Ş.
 BURAK ALÜMİNYUM SAN VE TIC. A.Ş.

ISO 14001 : 2004 + Cor 1 : 2009

Standard : ISO 14001 : 2004 + Cor 1 : 2009

Through a visit, documented in a report, I was satisfied that the management system of the client complies with the requirements of the standard.

ISO 14001 : 2004 + Cor 1 : 2009

Certificate registration no. : 21100095
 Valid from : 2014-06-02
 Valid until : 2017-06-02
 Date of certification : 2014-06-02



DCS GmbH

G. Blachschmidt
 G. Blachschmidt
 Geschäftsführer



Authorization
to use the quality sign



This is to certify that:

Burak Alüminyum Sanayi Ve Ticaret A.Ş.

Ünvanı: Mersinli Yolu Üzeri 3. Km.
TR - 30780 Eyyüphanlısan-Lihsburgaz / Kırklareli

Licence number: 1636

is authorized to use the quality sign which is shown above according to the REGULATIONS FOR THE USE OF THE QUALANOD QUALITY LABEL FOR SUP-ALUMINUM ACID-BASED ANODIZING OF ALUMINIUM.

Date of issue of the licence: 04.08.2014
Period of validity of the licence: until 31.12.2014

Zürich, 4 June 2014

QUALANOD

Thomas Baskler
President

CERTIFICATION BODY

Qualanod
Acid Etching
AG-Friedrichs SA
50224 AG

Qualanod address:
QUALANOD P.O. Box 1907, CH-8010 Zurich
Dürerstr.
QUALANOD AG-AG-Friedrichs SA, Tel: +41 43 810 2144

Phone: +41 43 810 2144
Fax: +41 43 810 2145
E-mail: info@qualanod.ch
Internet: www.qualanod.ch

Authorization

to use the quality sign



This is to certify that:

Burak Alüminyum Sanayi Ve Ticaret A.Ş.

Ünvanı: Mersinli Yolu Üzeri 3. Km.
TR - 39760 Eyyüphanlısan-Lihsburgaz / Kırklareli

Licence number: 1431

is authorized to use the quality sign which is shown above according to the REGULATIONS FOR THE USE OF THE QUALANOD QUALITY SIGN FOR PAINT, ENCOILER AND POWDER COATINGS ON ALUMINUM FOR ARCHITECTURAL APPLICATIONS

Date of issue of the licence: 14.07.2014
Period of validity of the licence: until 31.12.2014

Zürich, 14 July 2014

QUALICOAT

Volkermann C. Reuter
President

CERTIFICATION BODY

Qualicoat
Acid Etching
AG-Friedrichs SA
50224 AG

Qualicoat address:
QUALICOAT P.O. Box 1907, CH-8010 Zurich
Dürerstr.
QUALICOAT AG-AG-Friedrichs SA, Tel: +41 43 810 2144

Phone: +41 43 810 2144
Fax: +41 43 810 2145
E-mail: info@qualicoat.ch
Internet: www.qualicoat.ch

burak alüminyum



İstanbul Ofis / Istanbul Office
İstoç Oto ve Ticaret Merkezi
Tem Plaza No: 25 Kat: 3
Mahmutbey / İstanbul / Türkiye
Tel : +90 (212) 771 07 20 Pbx
Fax : +90 (212) 771 07 28

Lüleburgaz Fabrika / Factory
Uğurlu Dere Mevkii Muratlı Yolu üzeri
Büyükkarıştıran / Lüleburgaz
3. Km, 39780 Kırklareli / Türkiye
Tel : +90 444 37 40
Fax: +90 (288) 436 13 63

Esenyurt Mağaza / Esenyurt Store
Örnek Mah. Doğan Araslı Cad.
No: 207 34510, Esenyurt
İstanbul / Türkiye
Tel: +90 (212) 699 16 33
Fax: +90 (212) 699 27 33

Ankara Ofis 1 / Ankara Office 1
Karpuzlu 2. Caddesi
No: 107 Siteler, 06660
Ankara / Türkiye
Tel : +90 (312) 348 37 32 -
+90 (312) 348 42 72
Fax : +90 (312) 348 88 56

Ankara Ofis 2 / Ankara Office 2
35.Cad. (Yeni 1341. Cad.) No: 81/1
İvogsan, Yenimahalle / Ankara / Türkiye
Tel : +90 (312) 395 89 95
Fax : +90 (312) 395 89 97

Romanya Mağaza / Romania Store
Inter Lease Operational SRL
Sos, Pipera nr. 46C, sector 2
Bucuresti, CP 020112
Tel : +40 21 410 02 30 - 31
Fax : +40 21 410 41 85

