

hayatın her yerinde

in every aspect of life

MİMARİ SİSTEM KATALOĞU

FERMOSSA SYSTEM

ARCHITECTURAL SYSTEM CATALOGUE

MAESTRO - 60

kayar katlanır / sliding folding

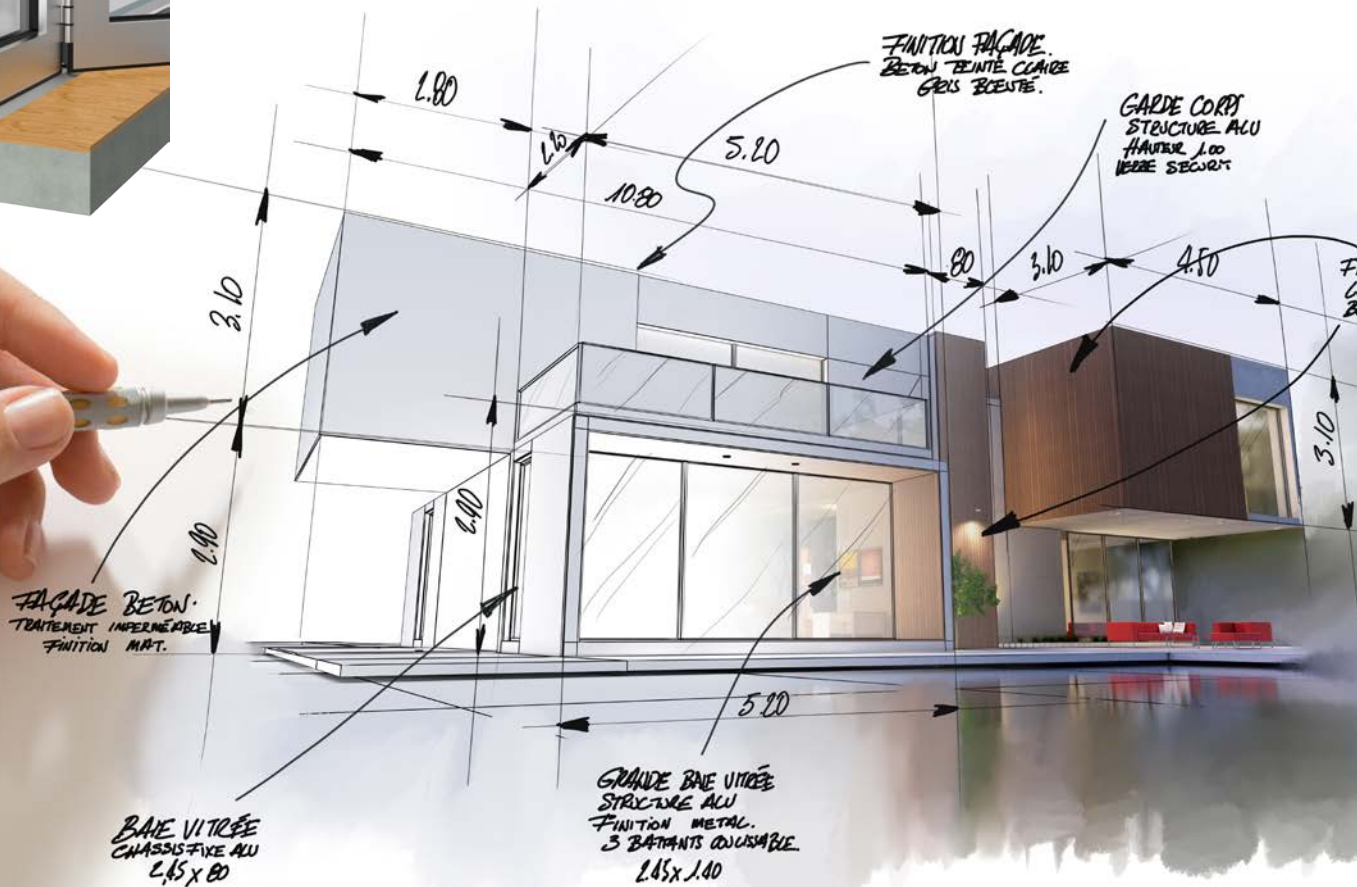
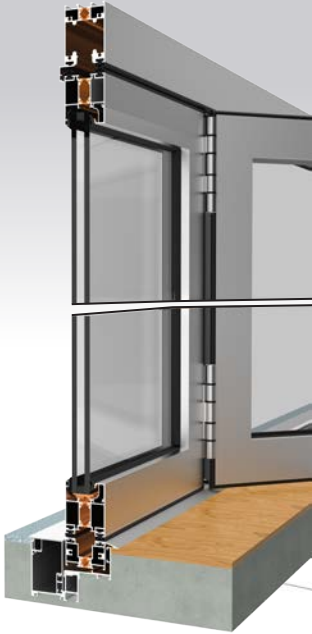

MAESTRO-60 Sliding Folding

MAESTRO-60 Katlanır Kapı: Yaygın kuklanım alanı ile sıkça tercih edilen alüminyum katlanır kapı sistemdir, kullanım kolaylığı sunması ve işlevi ile kullanıcılar tarafından güvenle tercih edilen bir üründür. Balkonlarda, bahçelerde kullanılabilen MAESTRO-60 Katlanır Kapı Sistemi, farklı mekanlar yaratmak isteyen kişiler tarafından şık ve estetik bir görünüm için kullanılmaktadır. Dış etkilerden etkilenmeyen, pratik kullanım imkanı veren ve iç mekanları ferahlatan MAESTRO-60 katlanır kapı sistemleri, dayanıklı ve ekonomik üründür. Düşük fiyatı ve yüksek verimliliği ile tercih edilen bu sistem, estetik açıdan üstün özelliklere sahiptir. Üstten taşıma ray üzerinde oluşturulmuş ve birbirine geçirilmiş panellerin hareket etmesi ile çalışan MAESTRO-60 katlanır kapı, ince yapısı ile yer kaplamamaktadır. Kolay çıkartılabilir özelliği ile katlanır kapılar ergonomik bir özellik taşımaktadır.

MAESTRO-60 Katlanır Kapı Sistemi Yalıtımda sağladığı avantaj nedeniyle, alışveriş merkezleri, restoranlar, iş, sağlık ve eğitim merkezleri gibi geniş mekanlarda tercih edilmektedir. Uzun yıllar güvenli ve sorunsuz bir şekilde kullanılabilir. Katlanır olması sayesinde, geniş açıklıklar da dış mekanla iç mekanı kesintisiz olarak birleştirme özelliğine sahiptir. Dört tarafından uygulanan EPDM contayla kesintisiz yalıtım sağlanmaktadır. Sistem, istenilen sayıda kanat uygulayabilme ve 24-45 mm kalınlığında ısıcam kullanabilme imkanı sunmaktadır.

MAESTRO-60 Folding Door: A widely preferred aluminum folding door system due to its vast range of uses, providing ease of use and functionality that make it a popular choice for users. The MAESTRO-60 Folding Door System, suitable for balconies, patios and gardens, is utilized by individuals looking to create different spaces with a stylish and aesthetic appearance. This system is resistant to external factors, offers practical use, and enhances indoor spaces with its airiness. Durable and economical, it is chosen for its low cost and high efficiency, boasting superior aesthetic features. The MAESTRO-60 folding door operates by panels moving along a top-carrying rail, seamlessly interlocking, and thanks to its slim design, it takes up minimal space. With its easy-to-remove feature, the folding doors offer an ergonomic solution.

The MAESTRO-60 Folding Door System is preferred in large spaces like shopping malls, restaurants, business, healthcare, and educational centers due to the insulation advantages it offers. It can be used safely and trouble-free for many years. Its folding-stacking feature allows for uninterrupted connection between indoor and outdoor spaces, even in large openings. A continuous seal is provided by EPDM gaskets applied on all four sides. The system allows for flexible panel application and the use of 24-45 mm thick insulated glass.

PROFIL TERMAL RAPORLARI

PROFILE THERMAL INSULATION VALUES

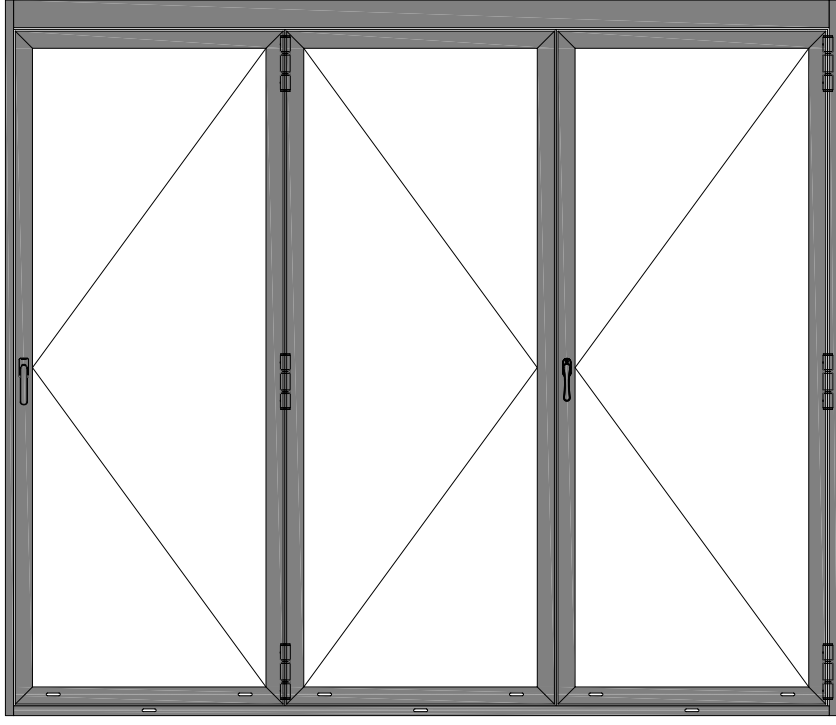
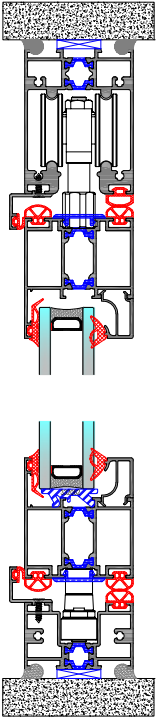
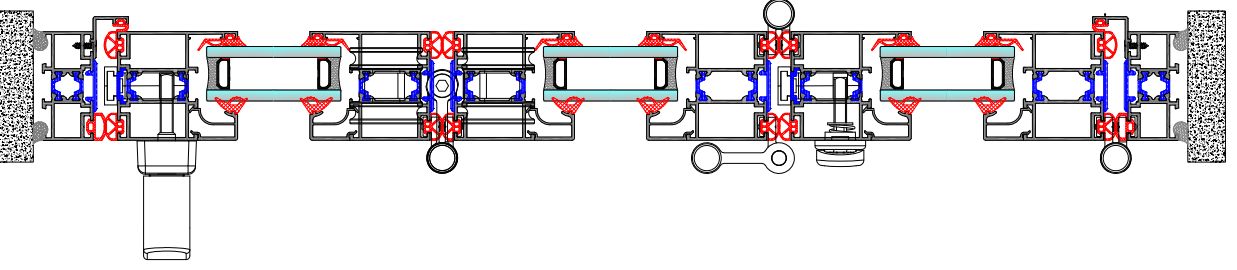
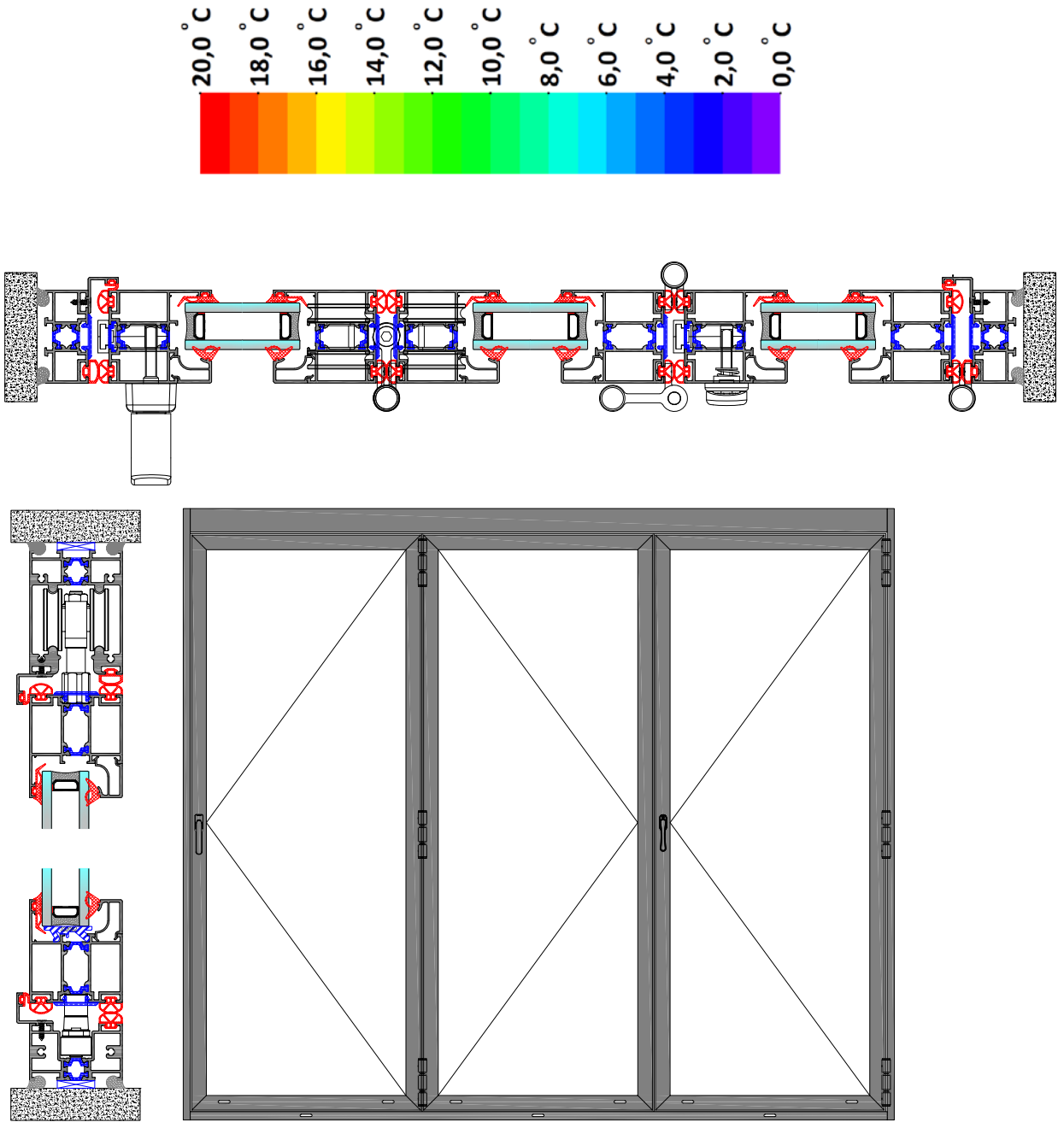

MAESTRO-60 Sliding Folding

TERMAL PERFORMANS DEĞERLERİ THERMAL PERFORMANCE VALUES

TERMAL HESAP KOŞULLARI!
THERMAL CALCULATION CONDITIONS

DIŞ ORTAM SICAKLIĞI: 0°C

(OUTER TEMPERATURE)

İÇ ORTAM SICAKLIĞI : 20°

(ROOM TEMPERATURE)

BAĞIL NEM : %50

(RELATIVE HUMIDITY)

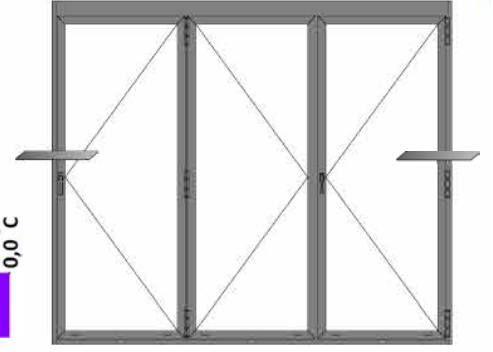
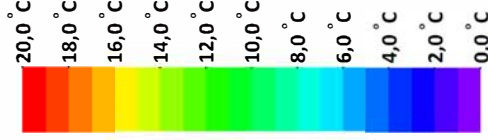

KESİT-1

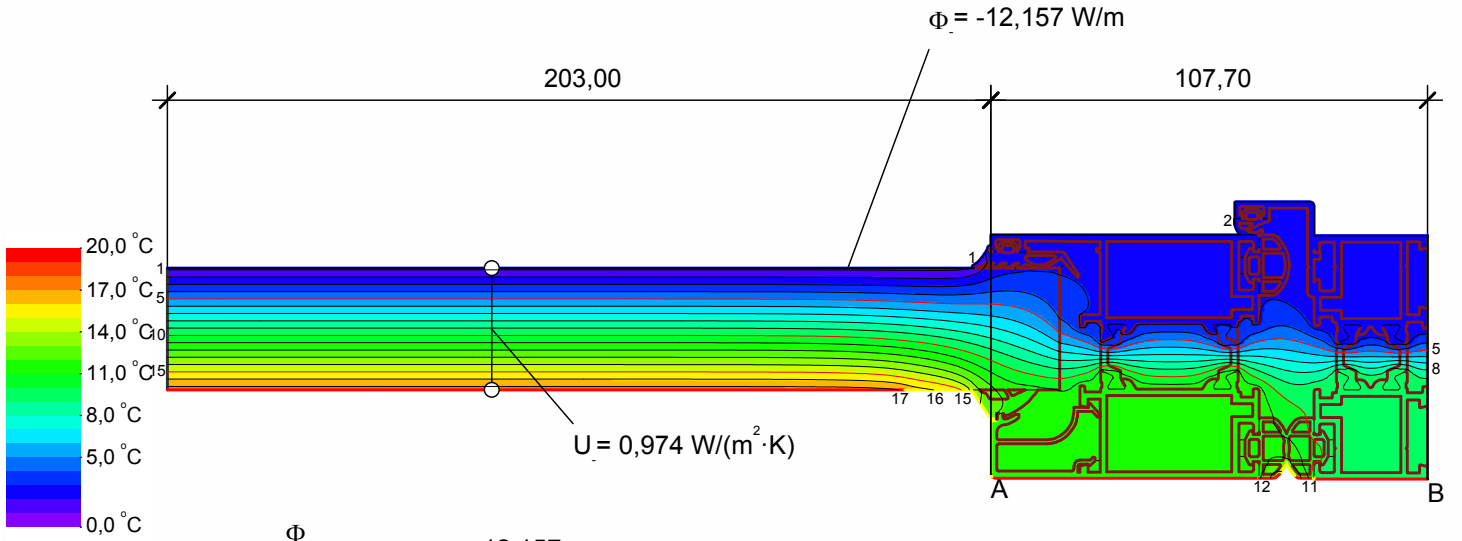

$$U_{f,A,B} = \frac{\frac{\Phi}{\Delta T} - U_p \cdot b_p}{b_f} = \frac{\frac{12,157}{20,000} - 0,974 \cdot 0,203}{0,108} = 3,81 \text{ W}/(\text{m}^2 \cdot \text{K})$$

Material	λ [W/(m·K)]	ϵ	Boundary Condition	q [W/m ²]	θ [°C]	R [(m ² ·K)/W]	ϵ
Aluminium (Si Alloys)	160,000	0,900	Epsilon 0,9				0,900
EPDM (ethylene propylene diene monomer)	0,250	0,900	Exterior, frame		0,000	0,040	
Panel	0,035	0,900	Interior, frame, normal		20,000	0,130	
Polyamid 6.6 with 25% glass fibre	0,300	0,900	Interior, frame, reduced		20,000	0,200	
Unventilated air cavity			Symmetry/Model section	0,000			

MAESTRO-60 Sliding Folding

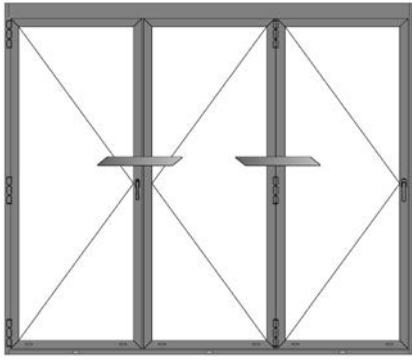

TERMAL PERFORMANS DEĞERLERİ THERMAL PERFORMANCE VALUES

TERMAL HESAP KOŞULLARI
THERMAL CALCULATION CONDITIONS

DIŞ ORTAM SICAKLIĞI: 0°C
(OUTER TEMPERATURE)

İÇ ORTAM SICAKLIĞI: 20°C
(ROOM TEMPERATURE)

BAĞIL NEM: %50
(RELATIVE HUMIDITY)

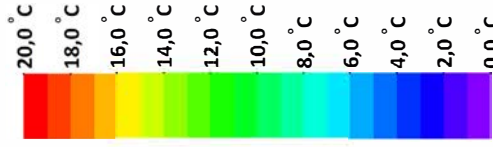

KESİT-2

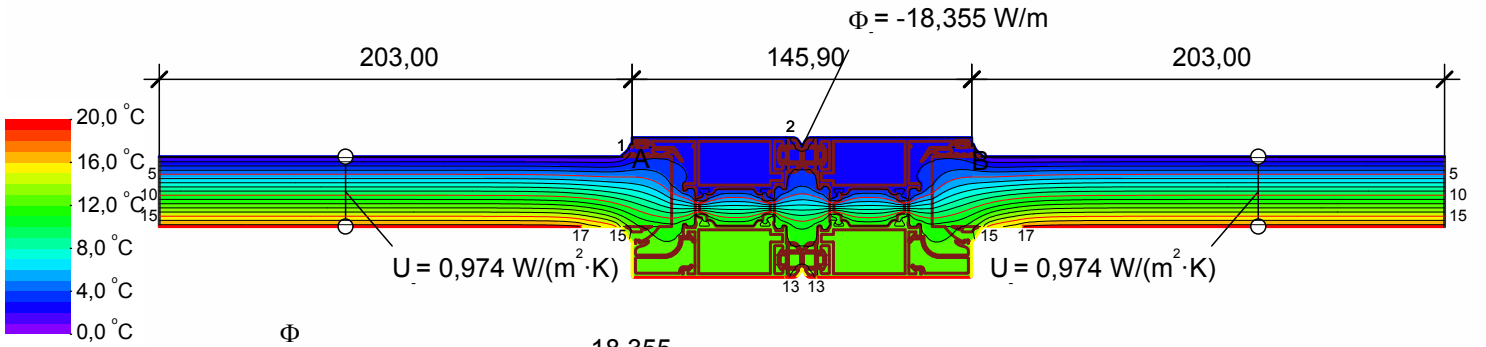

$$U_{f,A,B} = \frac{\Phi}{\Delta T} - \frac{U_{p1} \cdot b_{p1} - U_{p2} \cdot b_{p2}}{b_f} = \frac{18,355}{20,000} - \frac{0,974 \cdot 0,203 - 0,974 \cdot 0,203}{0,146} = 3,58 \text{ W/(m}^2 \cdot \text{K)}$$

Material	λ [W/(m·K)]	ϵ	Boundary Condition	q [W/m ²]	θ [°C]	R [(m ² ·K)/W]	ϵ
Aluminium (Si Alloys)	160,000	0,900	Epsilon 0.9				0,900
EPDM (ethylene propylene diene monomer)	0,250	0,900	Exterior, frame		0,000	0,040	
Panel	0,035	0,900	Interior, frame, normal		20,000	0,130	
Polyamid 6.6 with 25% glass fibre	0,300	0,900	Interior, frame, reduced		20,000	0,200	
Unventilated air cavity			Symmetry/Model section	0,000			

MAESTRO-60 Sliding Folding

TERMAL PERFORMANS DEĞERLERİ THERMAL PERFORMANCE VALUES

TERMAL HESAP KOŞULLARI!

THERMAL CALCULATION CONDITIONS

DIŞ ORTAM SICAKLIĞI: 0°C
(OUTER TEMPERATURE)

İÇ ORTAM SICAKLIĞI: 20°C
(ROOM TEMPERATURE)

BAĞIL NEM: %50
(RELATIVE HUMIDITY)

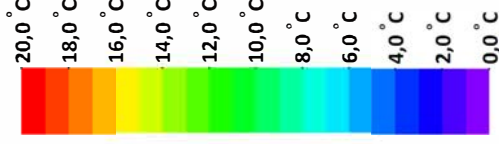

KESİT-3

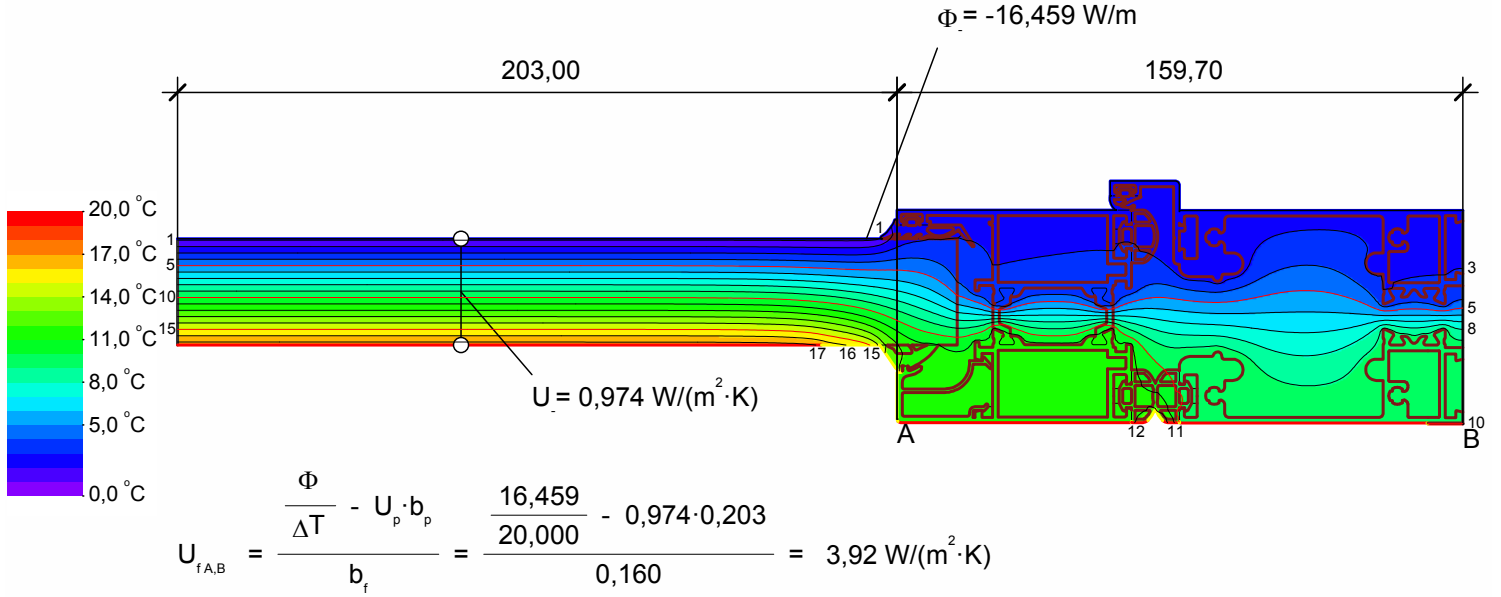

Material	λ [W/(m·K)]	ϵ	Boundary Condition	q [W/m ²]	θ [°C]	R [(m ² ·K)/W]	ϵ
Aluminium (Si Alloys)	160,000	0,900	Epsilon 0.9				0,900
EPDM (ethylene propylene diene monomer)	0,250	0,900	Exterior, frame	0,000		0,040	
Panel	0,035	0,900	Interior, frame, normal	20,000		0,130	
Polyamid 6.6 with 25% glass fibre	0,300	0,900	Interior, frame, reduced	20,000		0,200	
Unventilated air cavity			Symmetry/Model section	0,000			

MAESTRO-60 Sliding Folding

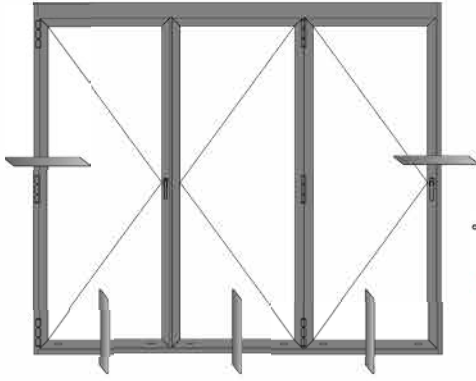

TERMAL PERFORMANS DEĞERLERİ THERMAL PERFORMANCE VALUES

TERMAL HESAP KOŞULLARI!
THERMAL CALCULATION CONDITIONS

DIŞ ORTAM SICAKLIĞI: 0°C
(OUTER TEMPERATURE)

İÇ ORTAM SICAKLIĞI: 20°C
(ROOM TEMPERATURE)

BAĞIL NEM: %50
(RELATIVE HUMIDITY)

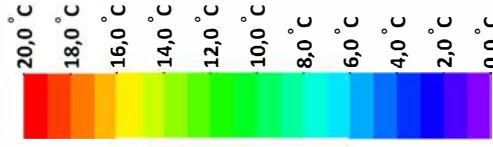

KESİT-4

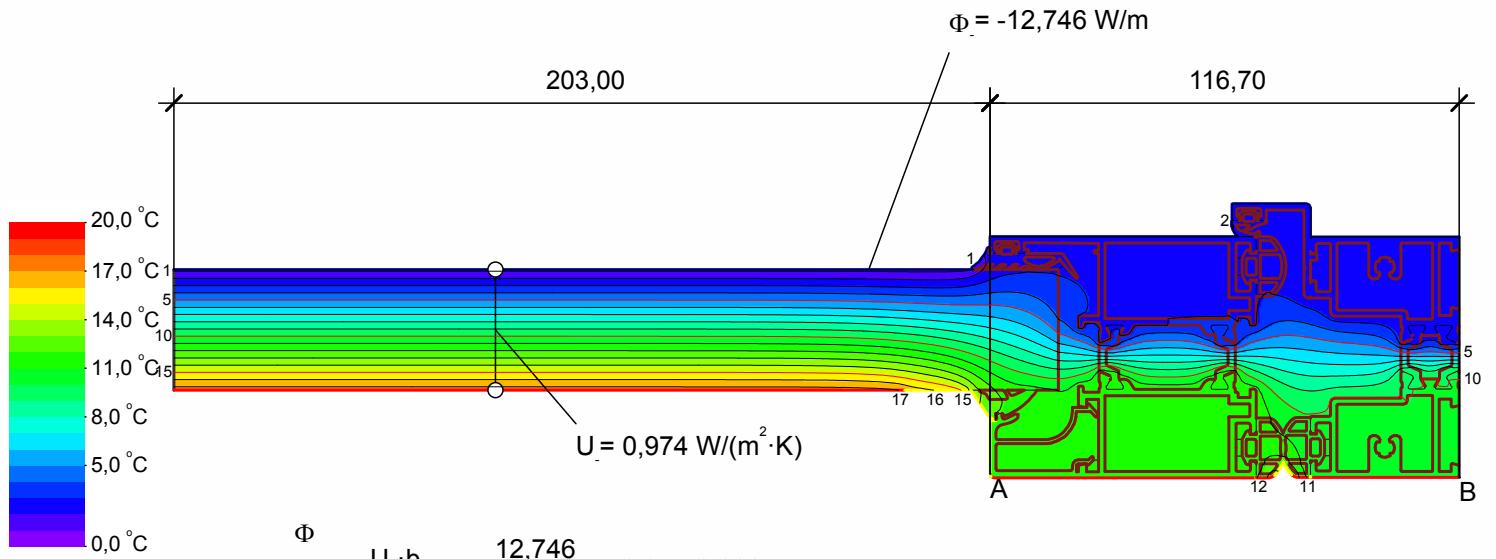

$$U_{f,A,B} = \frac{\frac{\Phi}{\Delta T} - U_p \cdot b_p}{b_f} = \frac{\frac{12,746}{20,000} - 0,974 \cdot 0,203}{0,117} = 3,77 \text{ W/(m}^2 \cdot \text{K)}$$

Material	λ [W/(m·K)]	ϵ	Boundary Condition	q [W/m ²]	θ [°C]	R [(m ² ·K)/W]	ϵ
Aluminium (Si Alloys)	160,000	0,900	Epsilon 0.9				0,900
EPDM (ethylene propylene diene monomer)	0,250	0,900	Exterior, frame	0,000		0,040	
Panel	0,035	0,900	Interior, frame, normal	20,000		0,130	
Polyamid 6.6 with 25% glass fibre	0,300	0,900	Interior, frame, reduced	20,000		0,200	
Unventilated air cavity			Symmetry/Model section	0,000			

MAESTRO-60 Sliding Folding



TEKNİK ÖZELLİKLER / TECHNICAL PROPERTIES

TEKNİK ÖZELLİKLER

TECHNICAL PROPERTIES

KASA DERİNLİĞİ / FRAME DEPTH :	60mm
KANAT DERİNLİĞİ / VENT DEPTH :	60mm
PROFİL ET KALINLIĞI / PROFILE WALL THICKNESS :	1,6mm
MAX. CAM KALINLIĞI / MAX. GLASS THICKNESS :	45 mm
ISI BARIYERLERİ / INSULATION BARS :	16 mm
ISI YALITIM DEĞERİ (Uf)-EN1077-2 / THERMAL INSULATION VALUE (Uf) :	(Uf): < 3,52 W/m ² K

KULLANIM SEÇENEKLERİ

APPLICATION ALTERNATIVES	PENCERE WINDOW	KAPI DOOR
EŞİKLİ KASA / THRESHOLD FRAME :	●	●
GÖMME KASA / CORRUGATED FLAT FLOOR FRAME :	●	●

MAESTRO-60 Sliding Folding

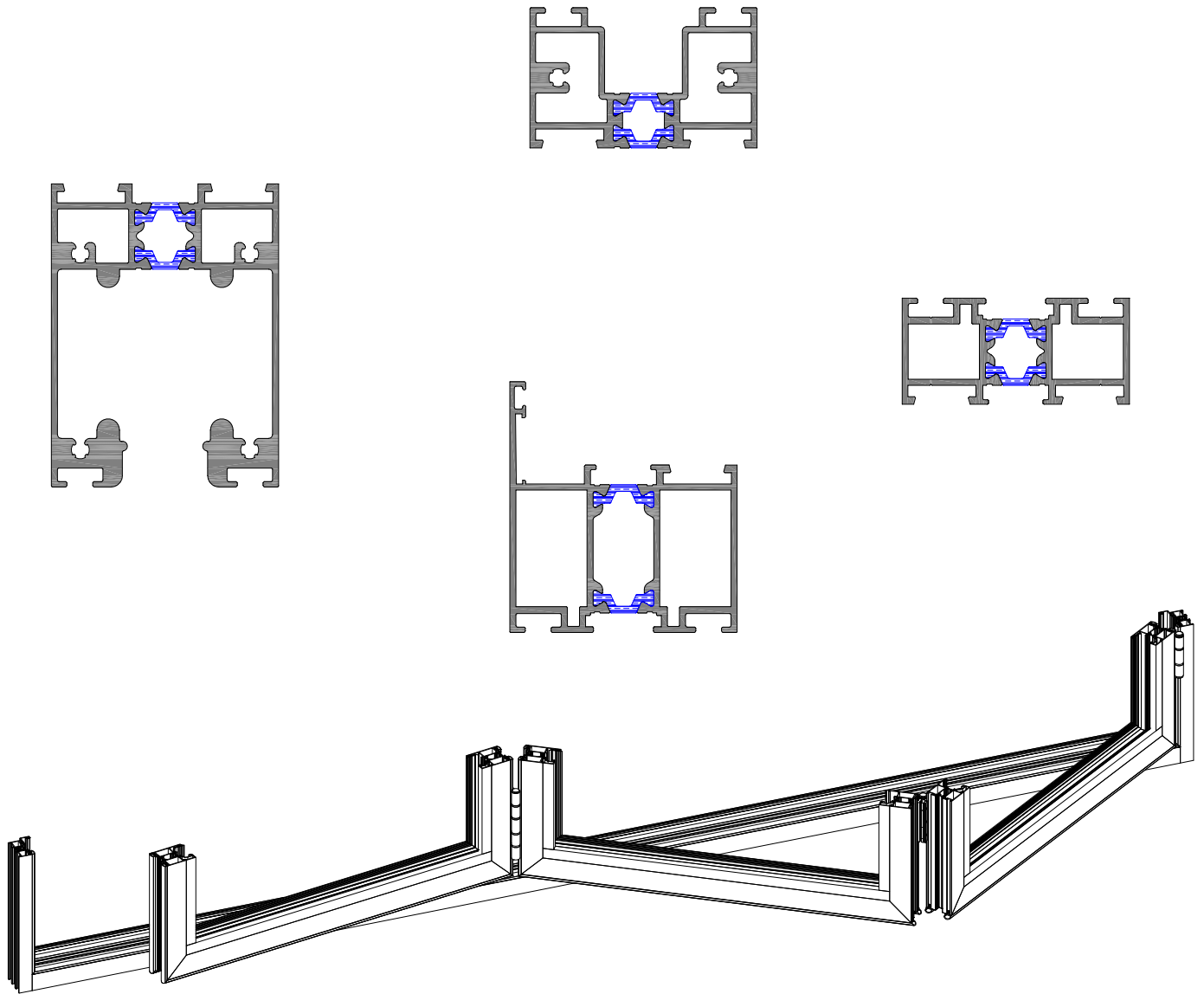

SİSTEM PROFİLLERİ

SYSTEM PROFILES

MAESTRO-60 Sliding Folding

BK-6014

Jx (cm ⁴)	Jy (cm ⁴)	y	x
58,88	44,58		
AĞIRLIK / WEIGHT			
2,788kg/m			

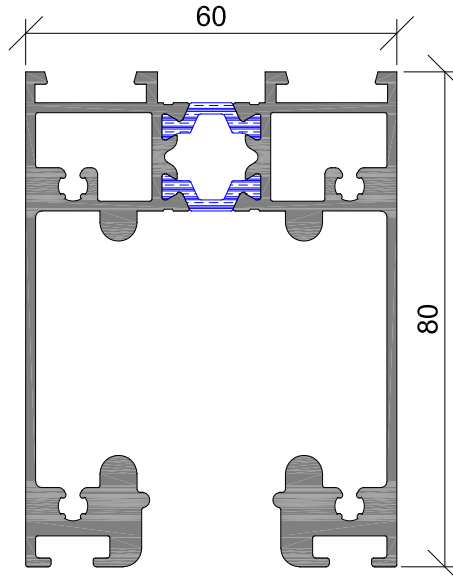

BK-6013

Jx (cm ⁴)	Jy (cm ⁴)	y	x
22,14	7,81		
AĞIRLIK / WEIGHT			
1,554kg/m			

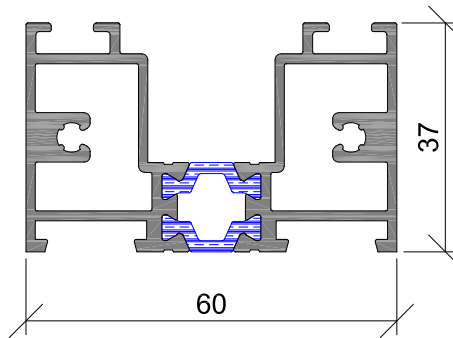

BK-6010

Jx (cm ⁴)	Jy (cm ⁴)	y	x
15,41	7,81		
AĞIRLIK / WEIGHT			
1,261kg/m			

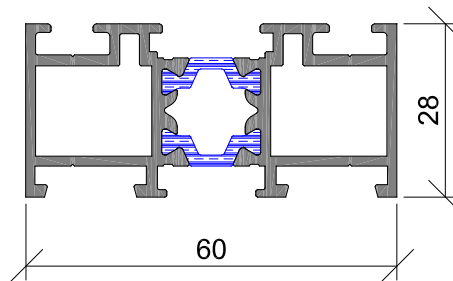

MAESTRO-60 Sliding Folding

BK-6012

KÖŞE BAĞLANTILARI
CORNER CLEATS AND ALIGNMENTS

A:111319
B:162010

Jx (cm ⁴)	Jy (cm ⁴)	y	x
16,06	25,32		
AĞIRLIK / WEIGHT			
1,597 kg/m			

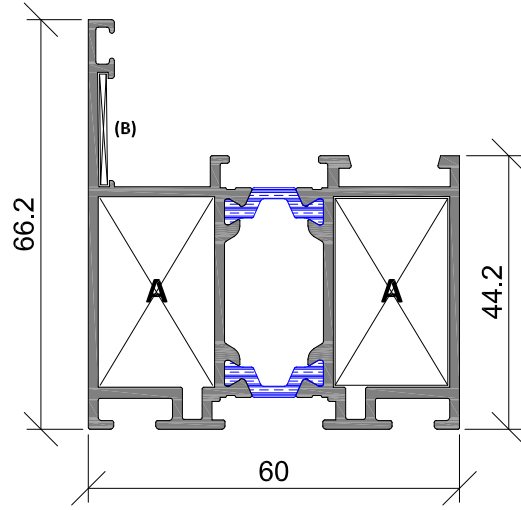

BK-6015

Jx (cm ⁴)	Jy (cm ⁴)	y	x
47,22	38,45		
AĞIRLIK / WEIGHT			
2,145kg/m			

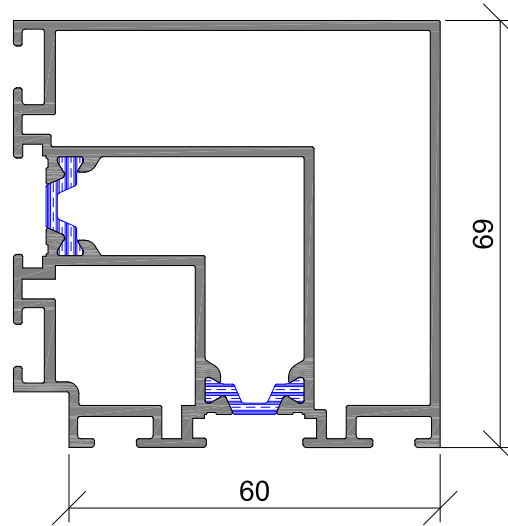

BK-6020

Jx (cm ⁴)	Jy (cm ⁴)	y	x
25,06	14,63		
AĞIRLIK / WEIGHT			
1,076kg/m			

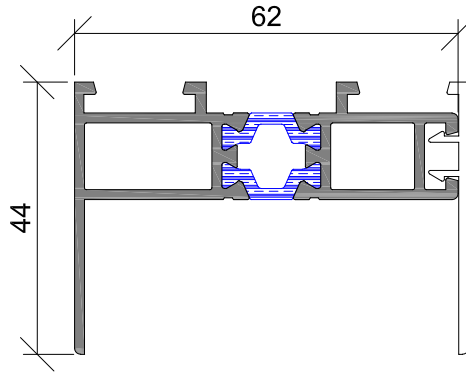

MAESTRO-60 Sliding Folding

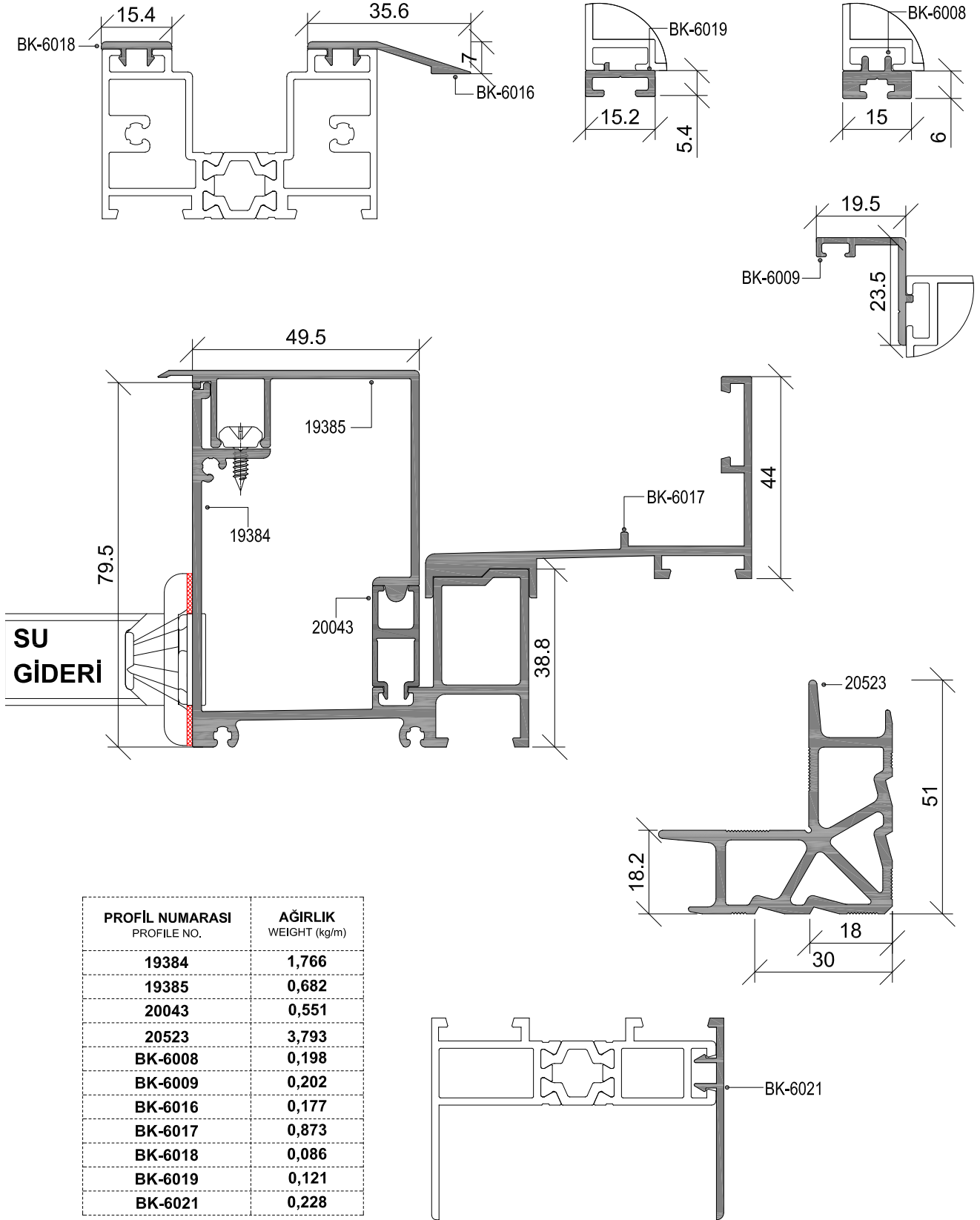

MAESTRO-60 Sliding Folding

CAM ÇITALARI / GLAZING BEAD PROFILES

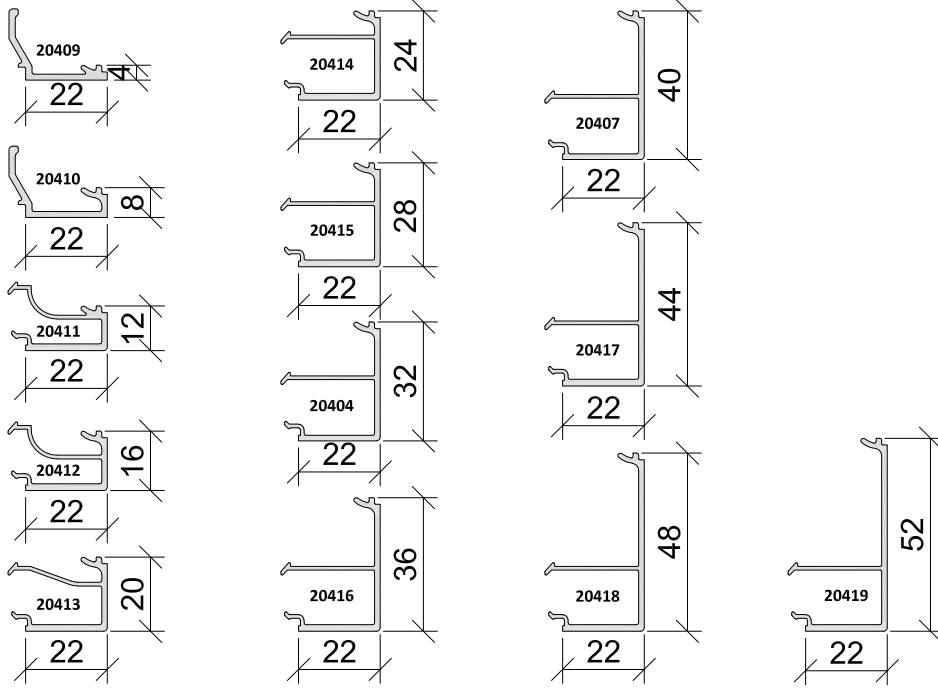

PROFİL NO PROFILE NO	GENİŞLİK WIDTH (mm)	ET KALINLIĞI WALL THICKNESS (mm)	AĞIRLIK WEIGHT (kg)
20409	4	1,8	0,208
20410	8	1,8	0,229
20411	12	1,8	0,255
20412	16	1,8	0,275
20413	20	1,8	0,295
20414	24	1,8	0,310
20415	28	1,8	0,326
20404	32	1,8	0,327
20416	36	1,8	0,358
20407	40	1,8	0,360
20417	44	1,8	0,391
20418	48	1,8	0,408
20419	52	1,8	0,424

MAESTRO-60 Sliding Folding

CAM KALINLIĞINA BAĞLI CAM ÇITASI SEÇİM TABLOSU GLAZING BEAD SELECTION TABLE ACCORDING TO THE GLASS THICKNESS

Profile	Inner Gasket Thickness (mm)	Outer Gasket Thickness (mm)
20419	3.8	52
20418	7.8	48
20417	11.8	44
20407	15.8	40
20416	19.8	36
20404	23.8	32
20415	27.8	28
20414	31.8	24
20413	35.8	20
20412	39.8	16
20411	43.8	12
20410	47.8	8
20409	51.8	4

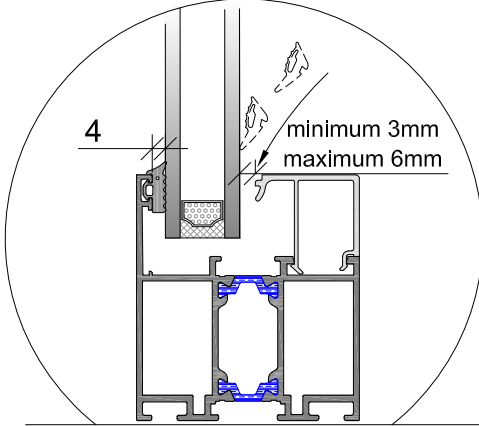
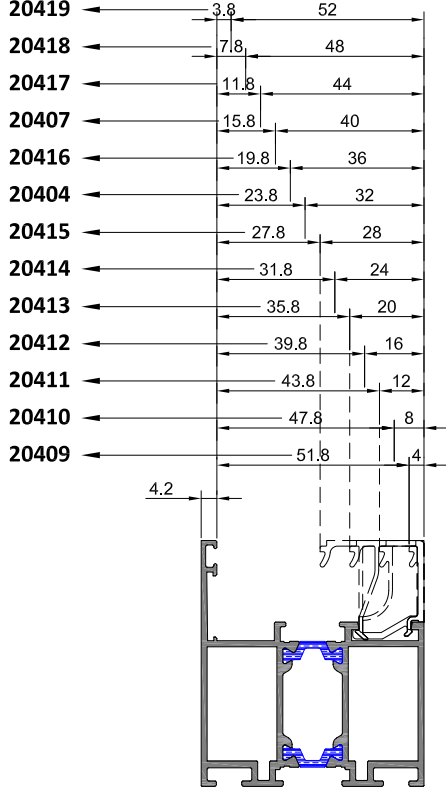

**** YUKARIDA GÖRÜLEN PROFİL VE FİTİL İLİŞKİLERİ TEORİKTİR.**
THE RELATION BETWEEN PROFILES & GASKETS ARE THEORETICAL AS SEEN ABOVE.

DIŞ FİTİLLER STANDART EBATTA OLUP 4mm KALINLIĞINDADIR. İÇTEKİ KAMA FİTİLİN BOŞLUĞU İSE, MİNİMUM 3mm MAKSİMUM 6mm OLACAK ŞEKİLDE AYARLANMALIDIR.

THE OUTER GASKET'S DIMENSION ARE STANDARD WITH 4mm THICKNESS. THE INNER GASKET'S SPACE SHOULD BE ADJUSTED BETWEEN 3 - 6mm.

CAM VE PROFİL TOLERANSLARI + VEYA - YÖNDE BERABER ÇALIŞARAK TEORİDE OLMASI GEREKENDEN BÜYÜK VEYA KÜÇÜK BİR FİTİL BOŞLUĞUNA NEDEN OLABİLİR.

THE GLASS AND THE PROFILE TOLERANCES CAN BE WORK AT + OR - DIRECTION TOGETHER. IT CAUSES THE GASKET'S SPACE BIGGER OR SMALLER THAN NORMAL.

İÇ KAMA FİTİLLERİN YERİNE GEÇMESİNDE PROBLEM YAŞANMAMASI İÇİN, ÖNCELİKLE BİR NUMUNE ÜZERİNDE DENENMESİNİ TAVSİYE EDERİZ.

WE ADVISE THAT THE INNER GASKET AND GLAZING BEAD RELATION SHOULD BE CHECKED ON A MOCK-UP BEFORE.

MAESTRO-60 Sliding Folding

TIP(1)

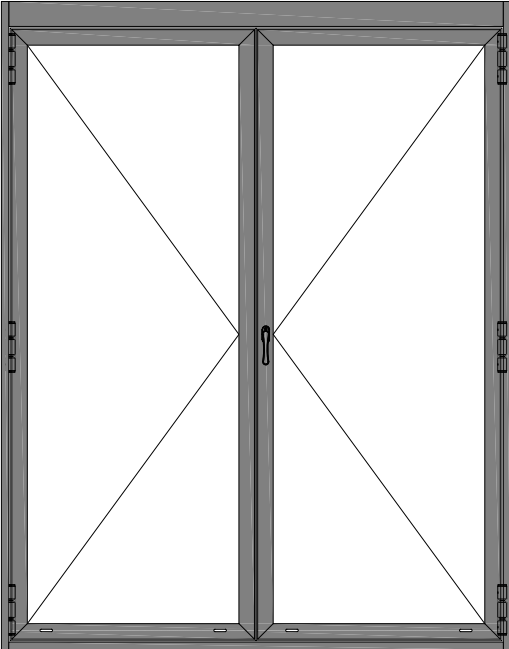

TIP(2)

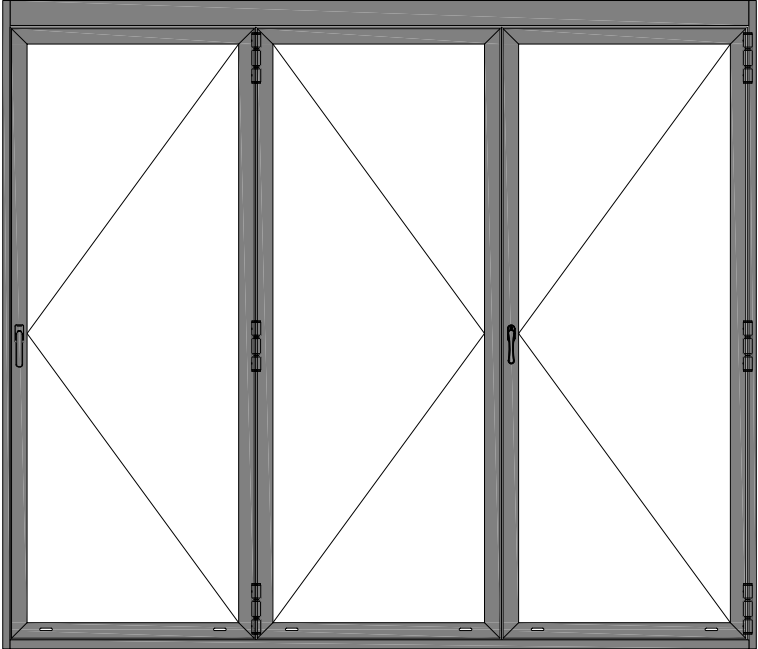

TIP(3)

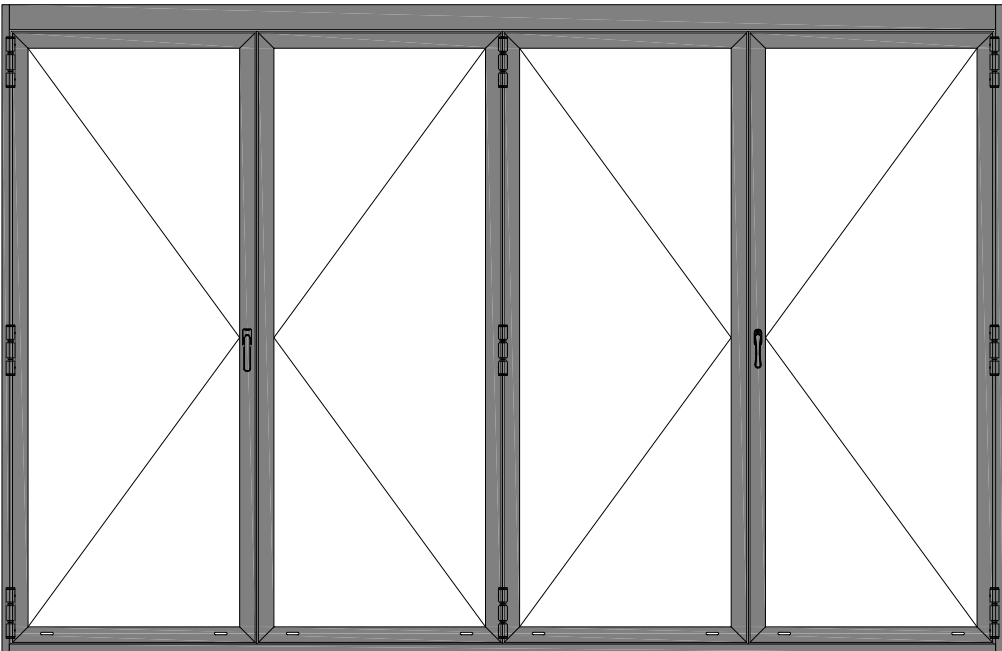

MAESTRO-60 Sliding Folding

UYGULANABİLİR AÇILIR TİPLERİ APPLICABLE WORKING TYPES

TİP(4)

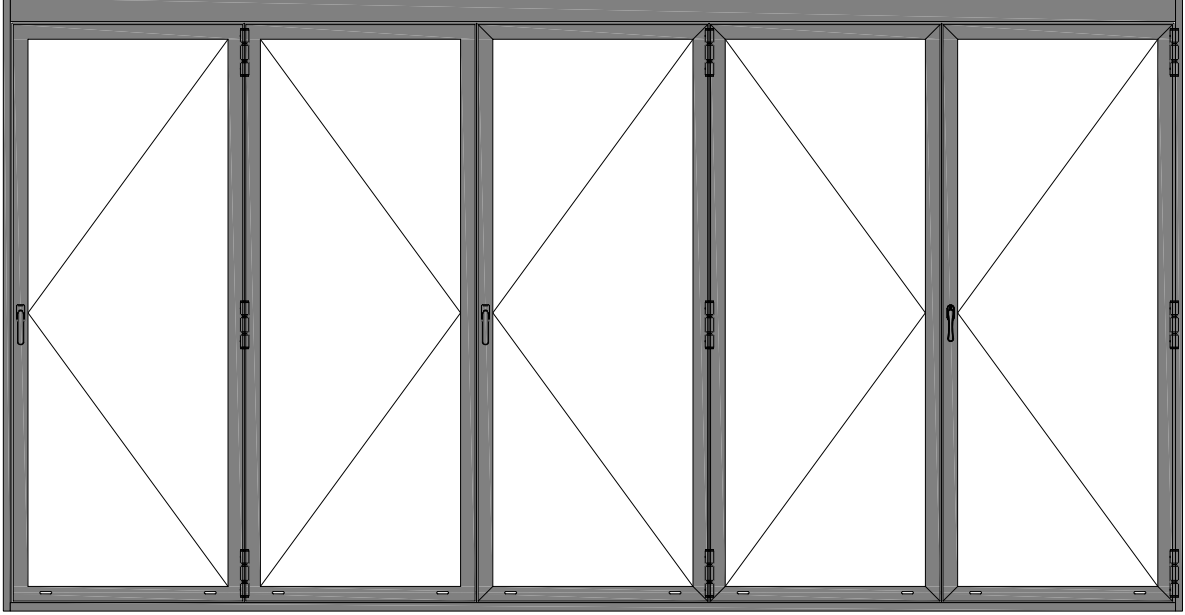

TİP(5)

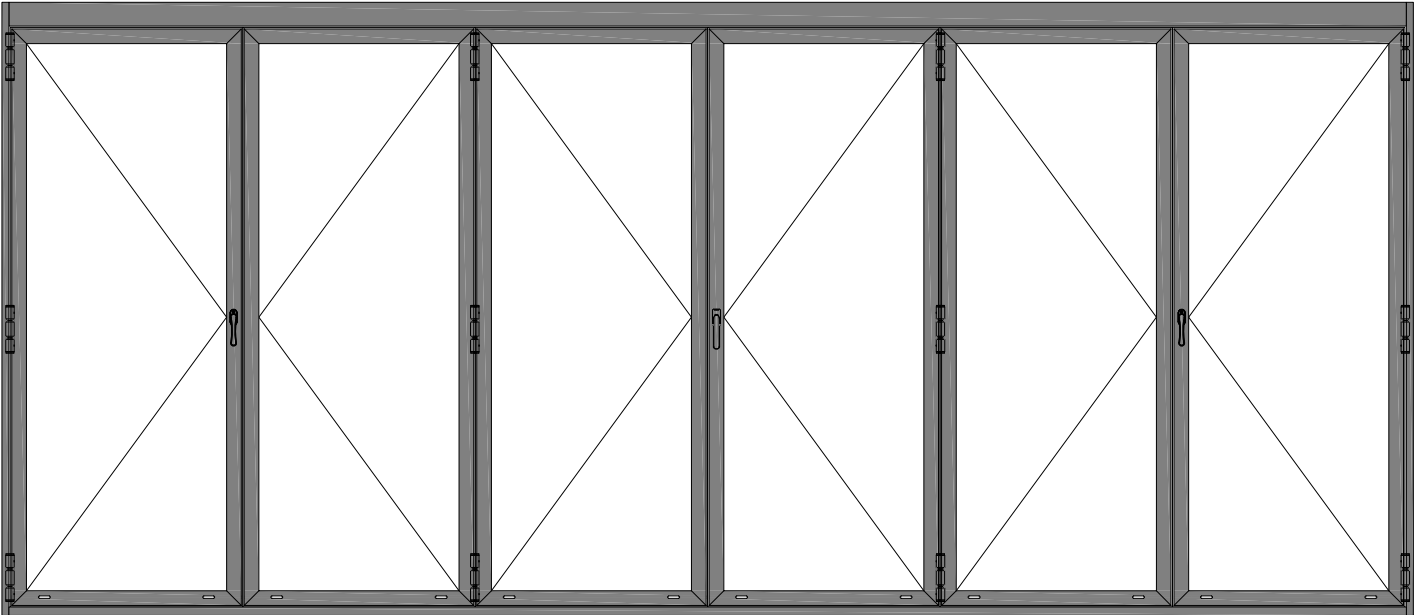

MAESTRO-60 Sliding Folding

SİSTEM KESİT DETAYLARI

SYSTEM SECTION DETAILS

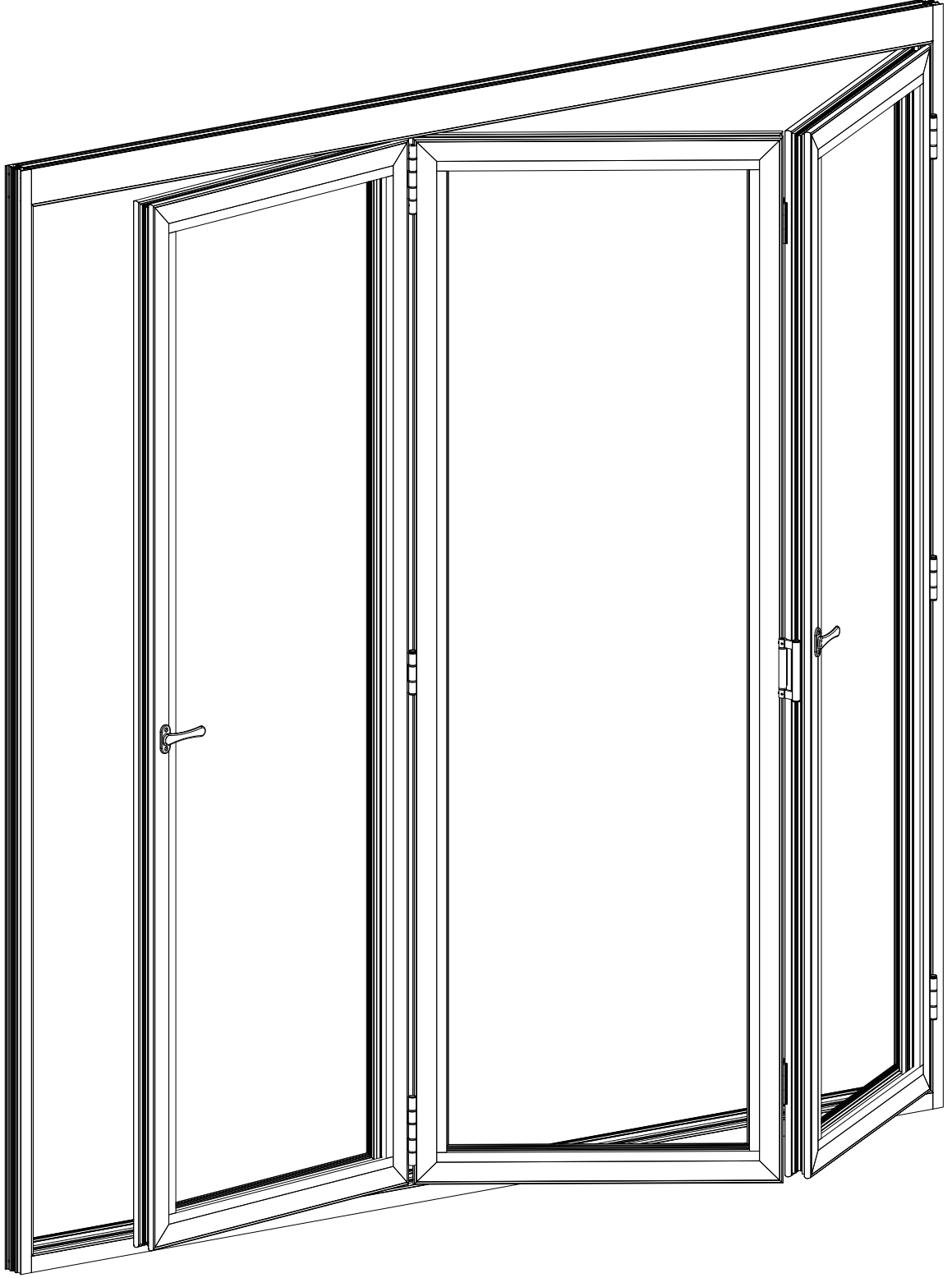

MAESTRO-60 Sliding Folding

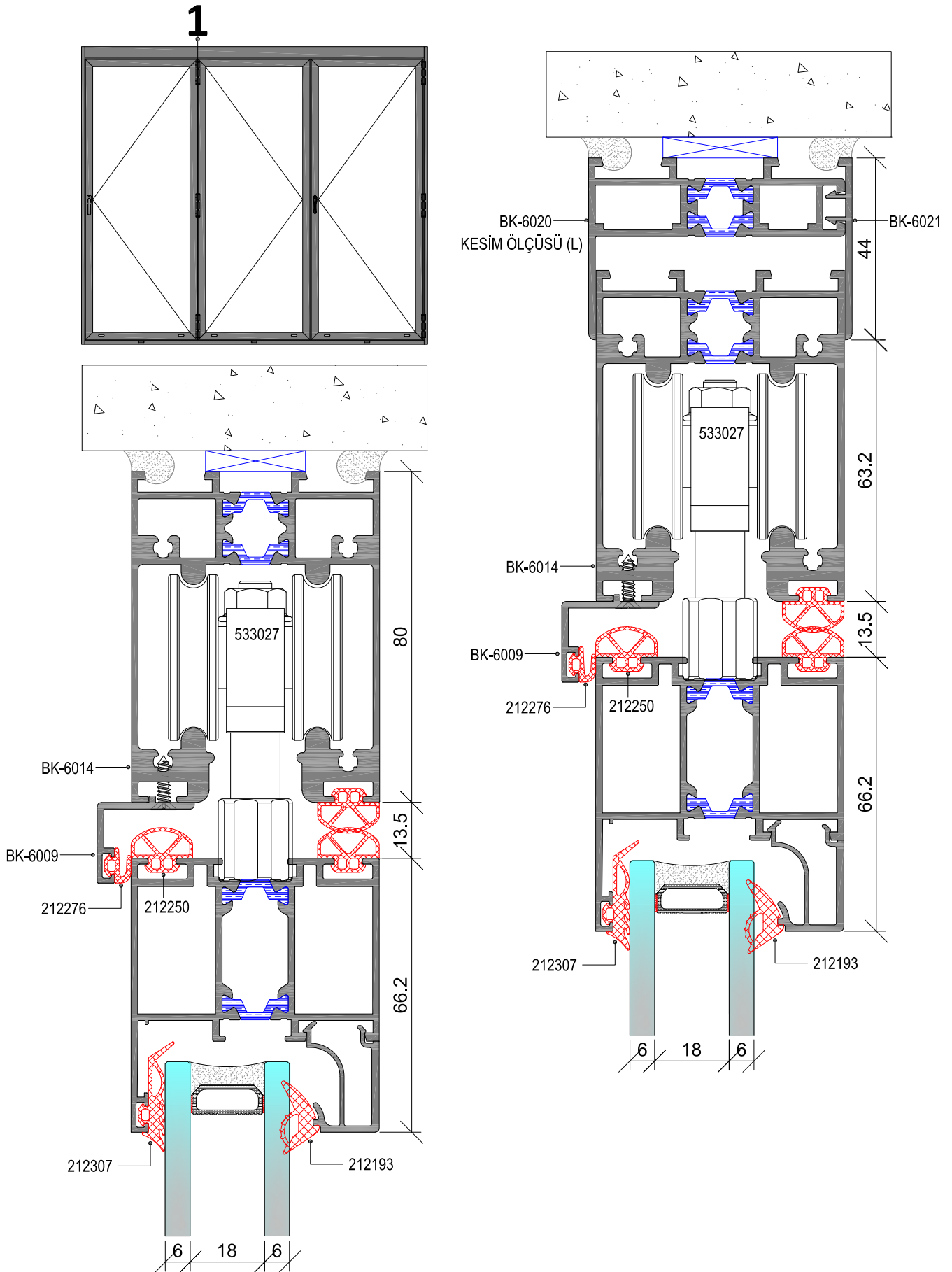

MAESTRO-60 Sliding Folding

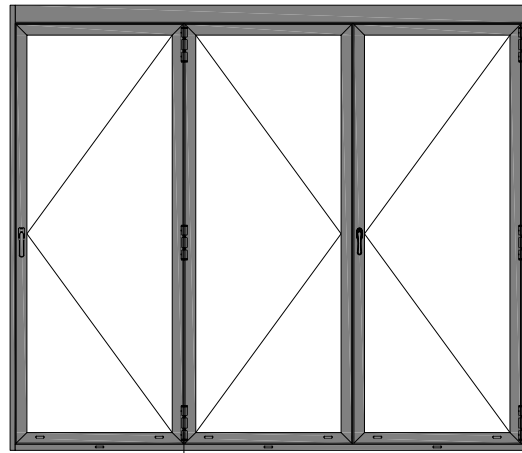

2

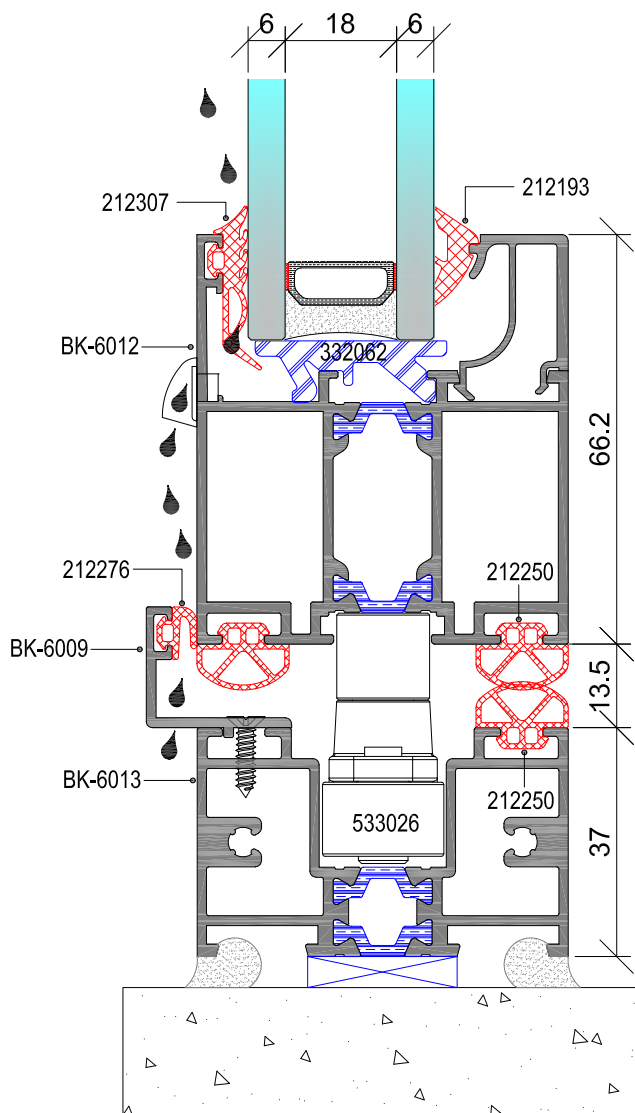

MAESTRO-60 Sliding Folding

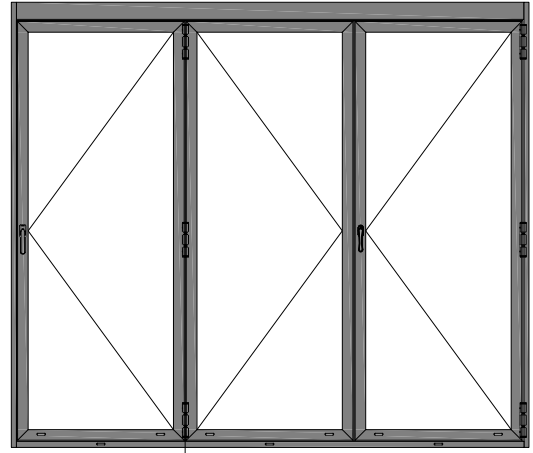

4 3

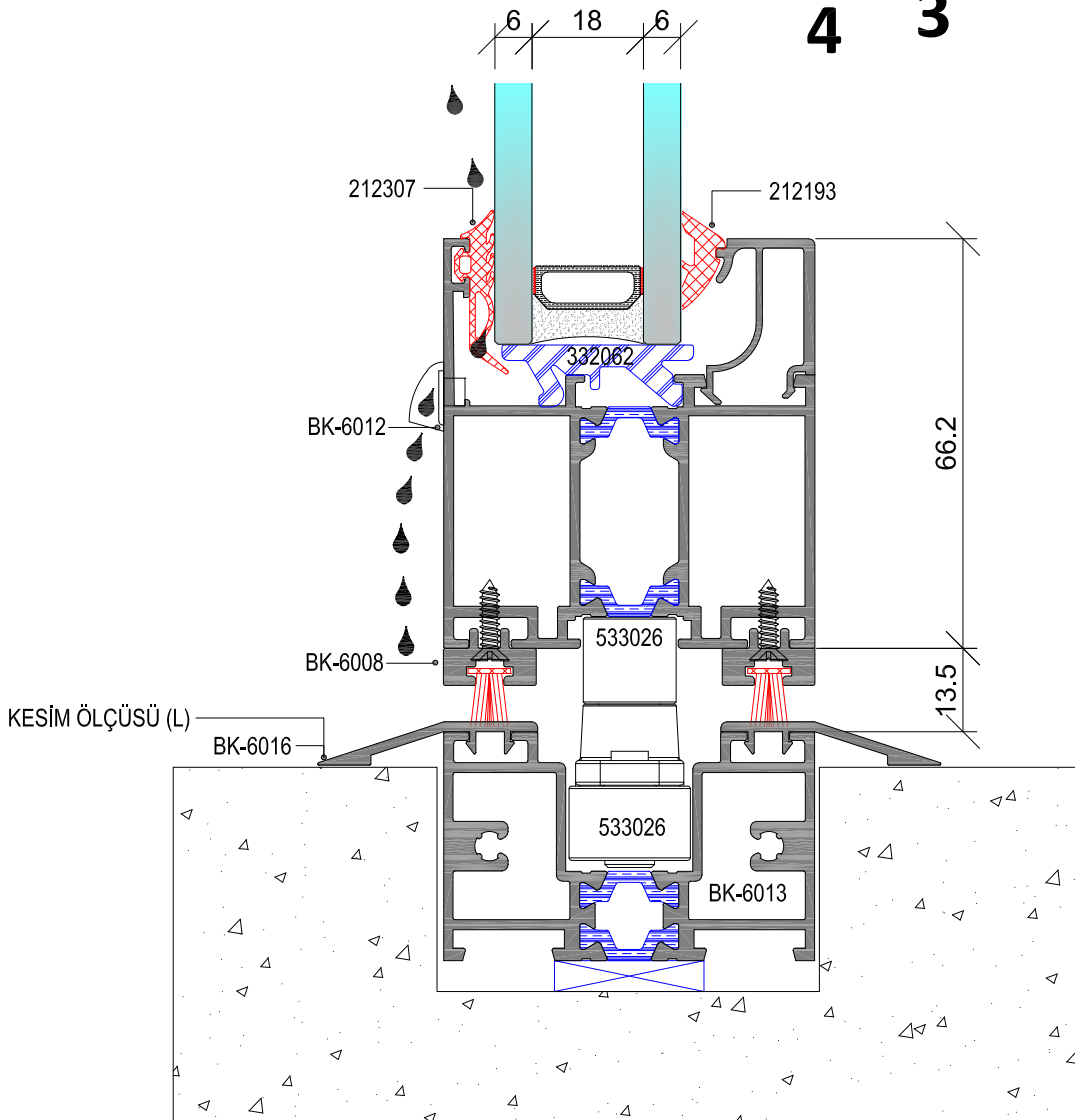

MAESTRO-60 Sliding Folding

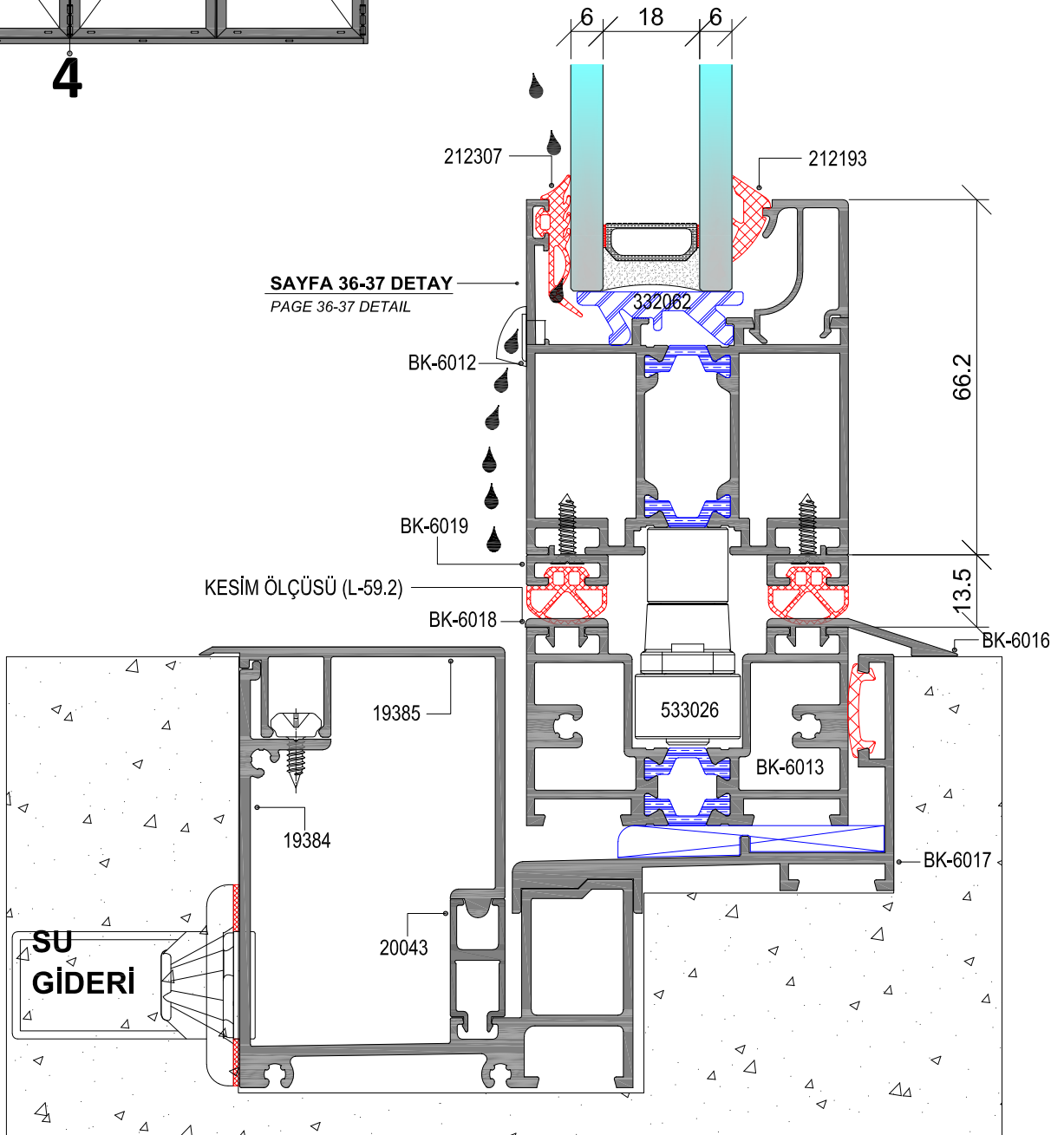
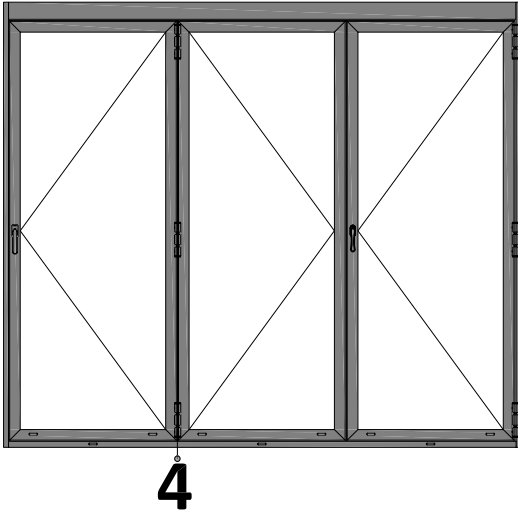

MAESTRO-60 Sliding Folding

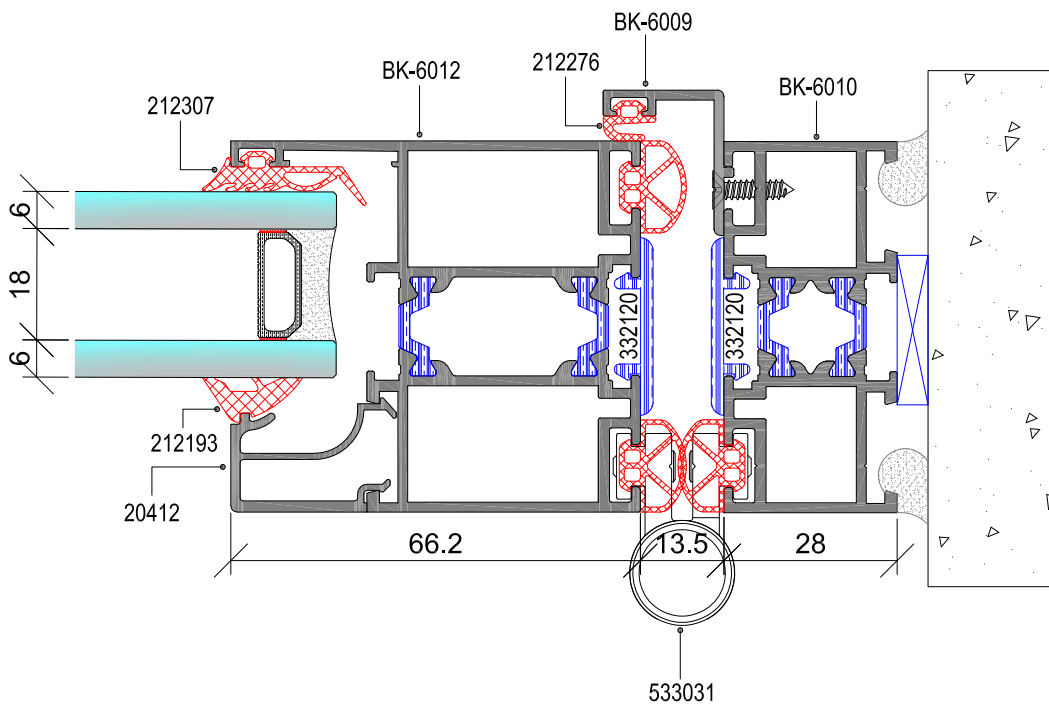
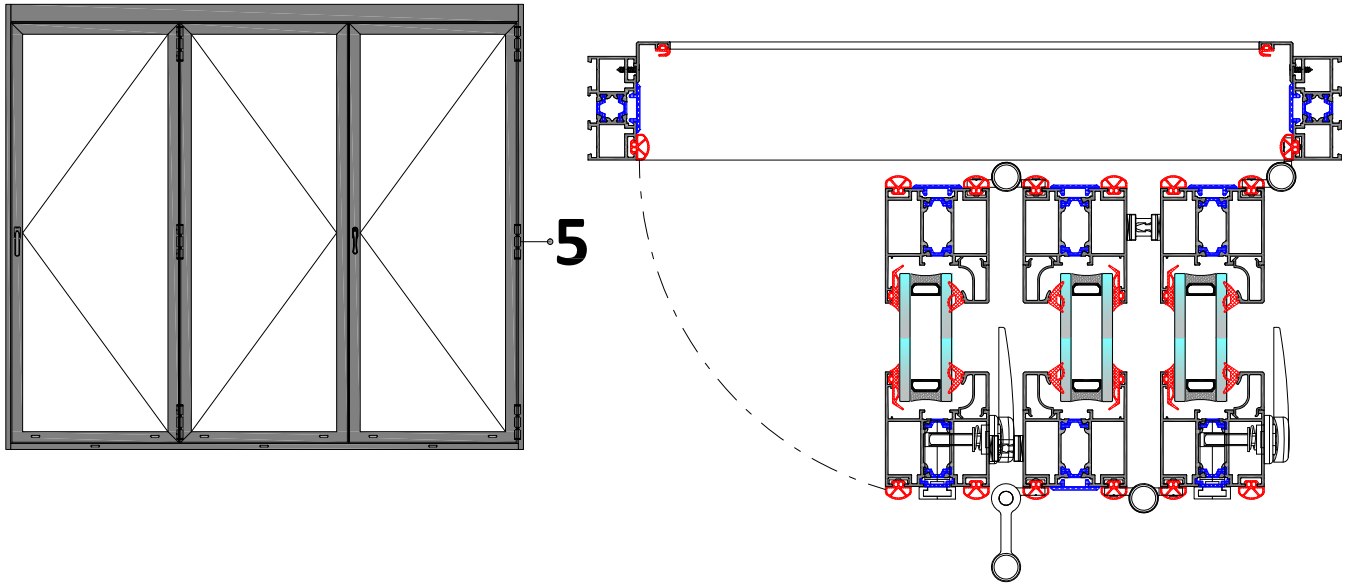

MAESTRO-60 Sliding Folding

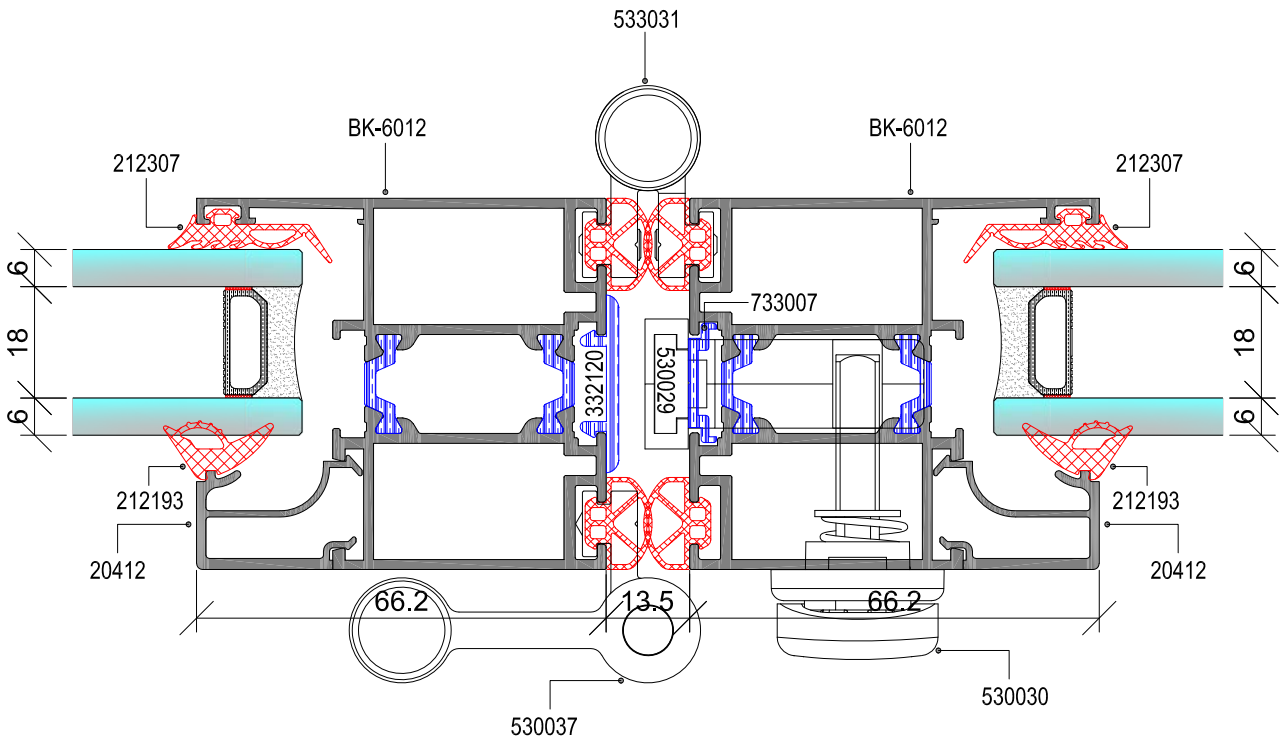
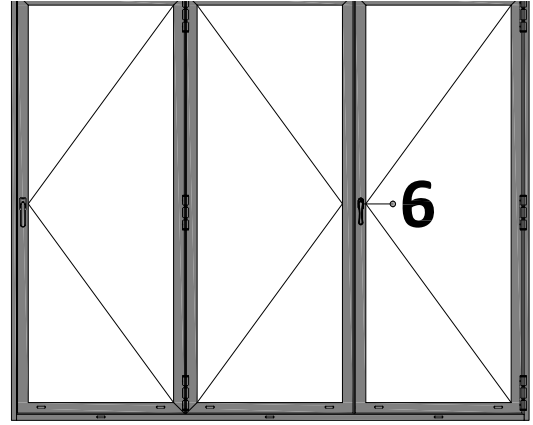
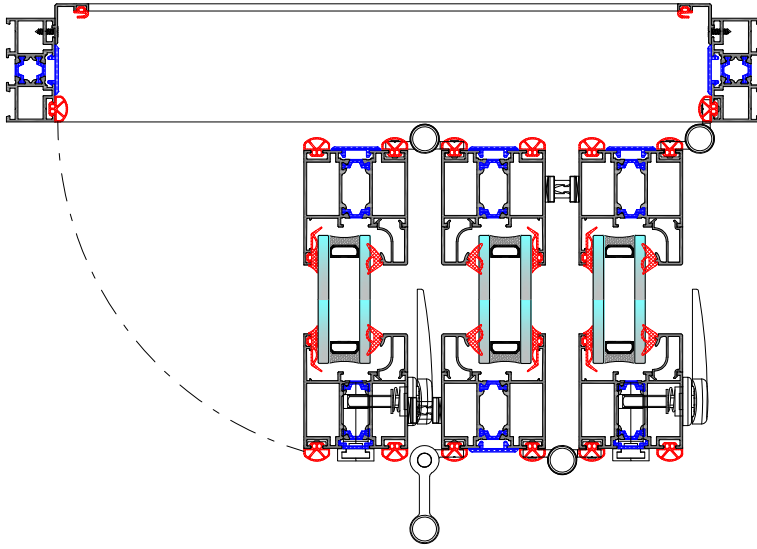

533035
ALT ÜST KİLİT
 UPPER LOWER LOCK

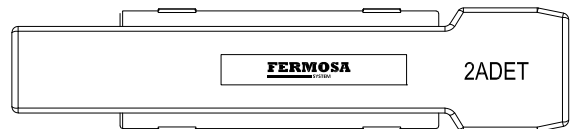

MAESTRO-60 Sliding Folding

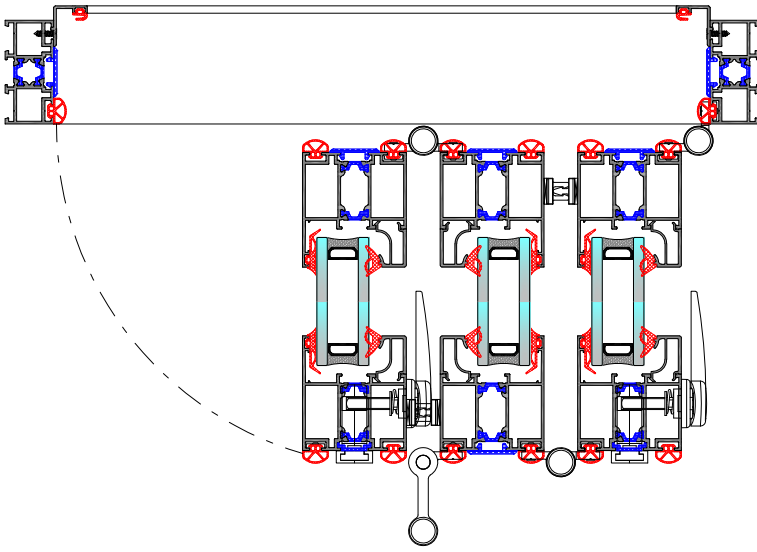

7

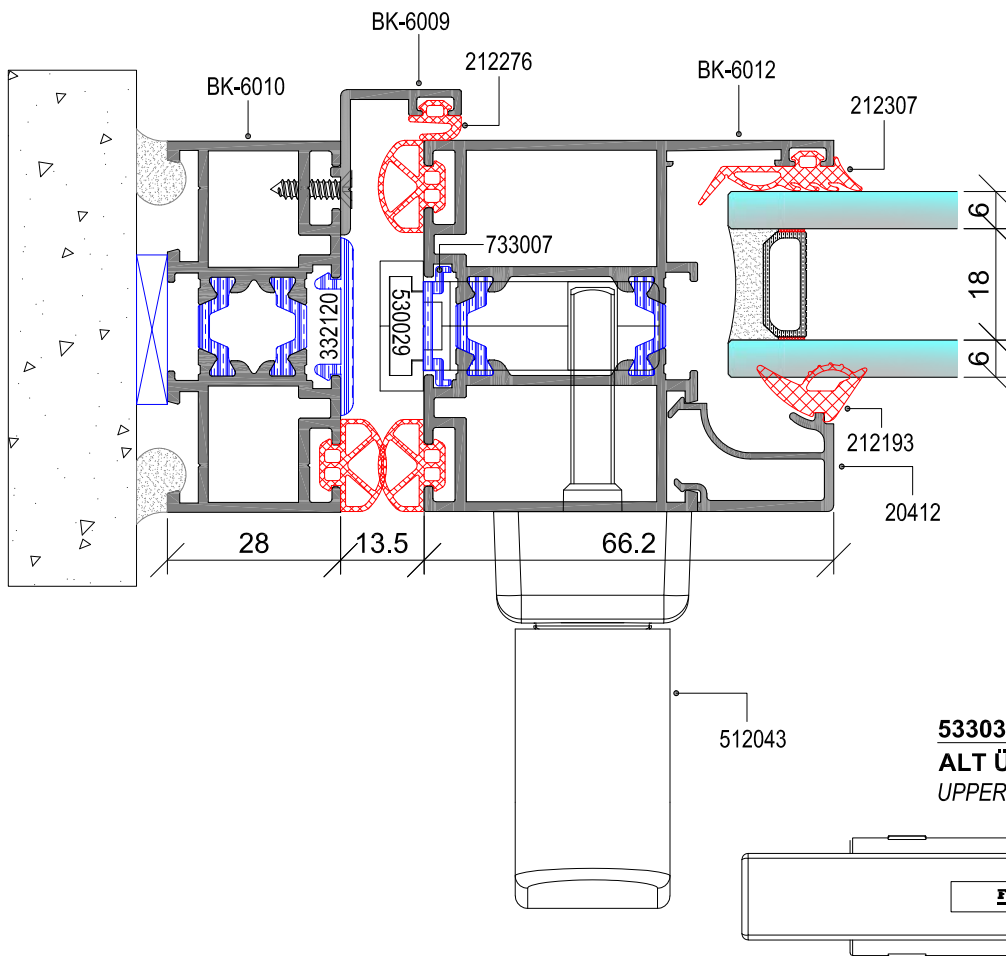
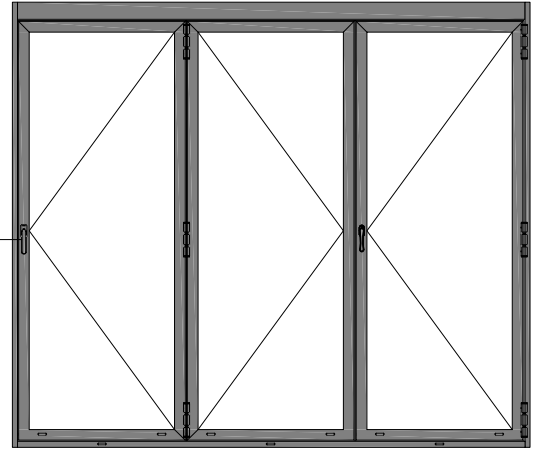

MAESTRO-60 Sliding Folding

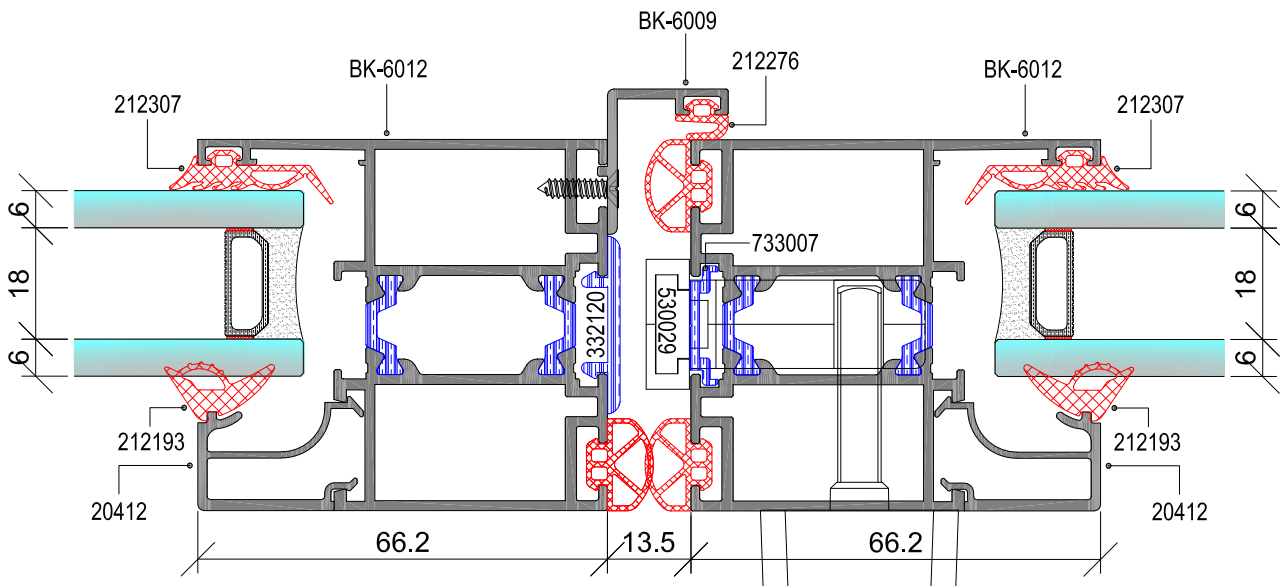
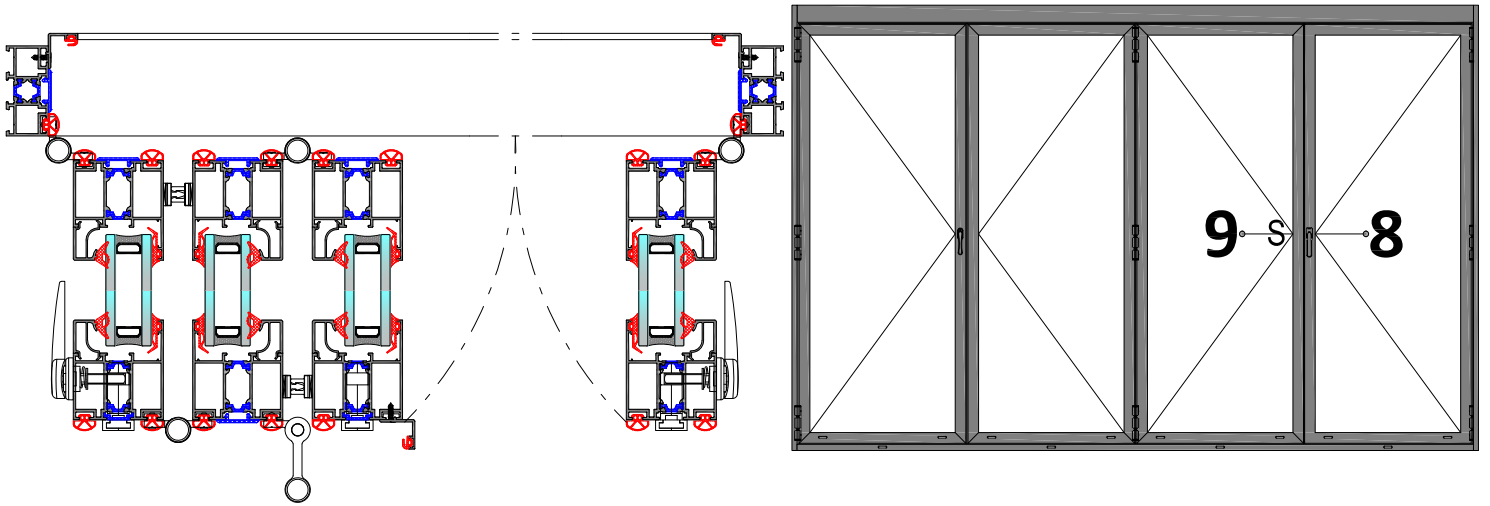

533035
ALT ÜST KİLİT
UPPER LOWER LOCK

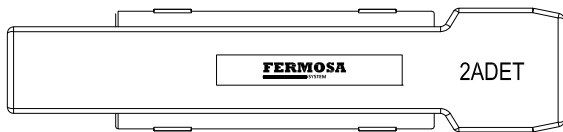

MAESTRO-60 Sliding Folding

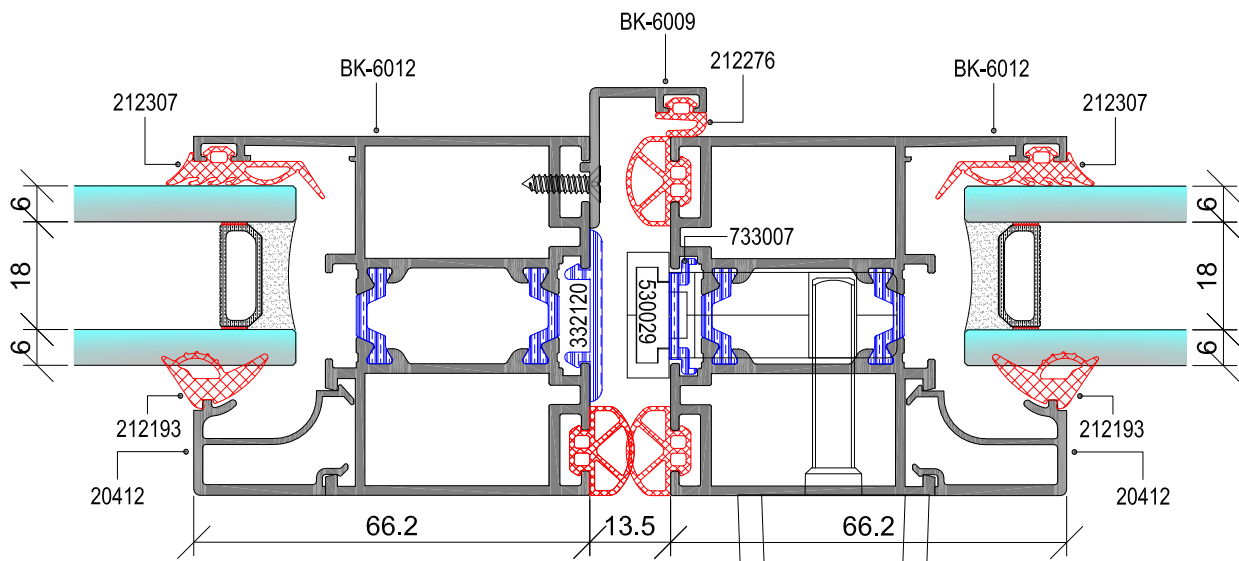
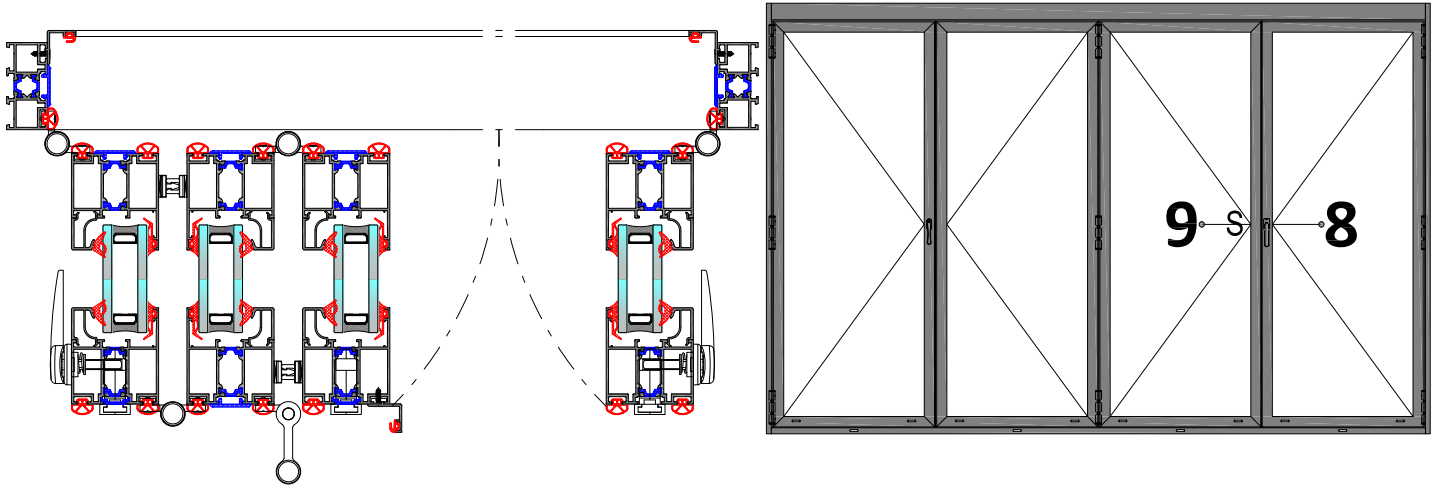

533035
ALT ÜST KİLİT
 UPPER LOWER LOCK

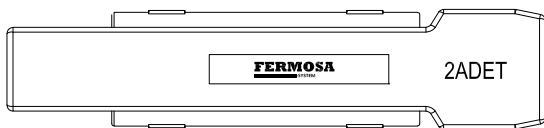

MAESTRO-60 Sliding Folding

HARELETLİ KÖŞE İÇE AÇILIR
MOVABLE CORNER OPENS

533035
ALT ÜST KİLİT
UPPER LOWER LOCK

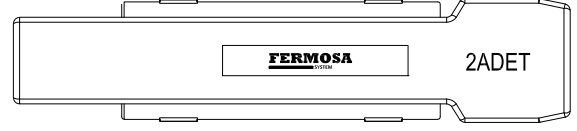

742010
GİZLİ TELLİ KİLİT
HIDDEN STEEL LOCK

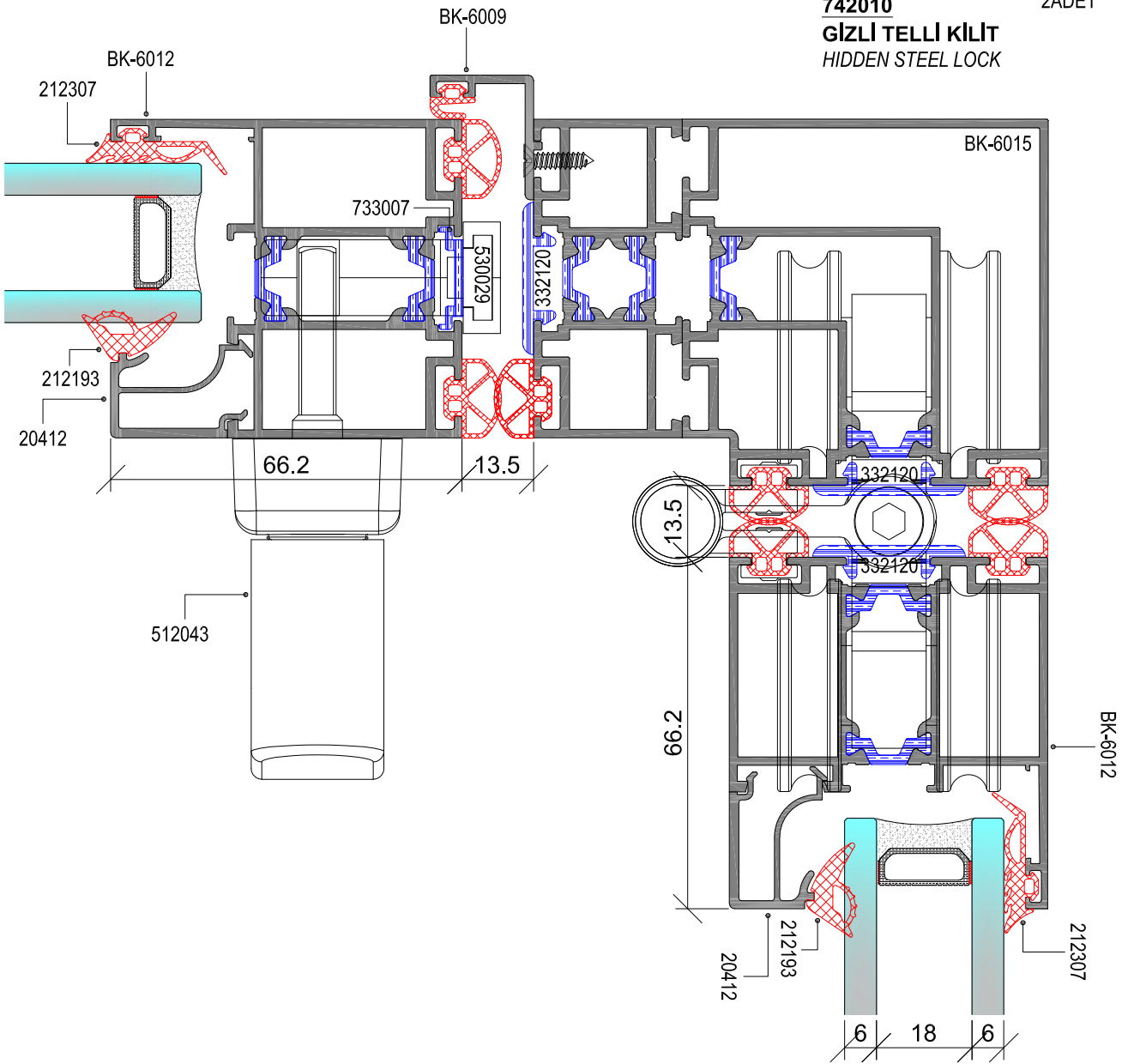

İMALAT ÜRETİM DETAYLARI PRODUCTION APPLICATION DETAILS

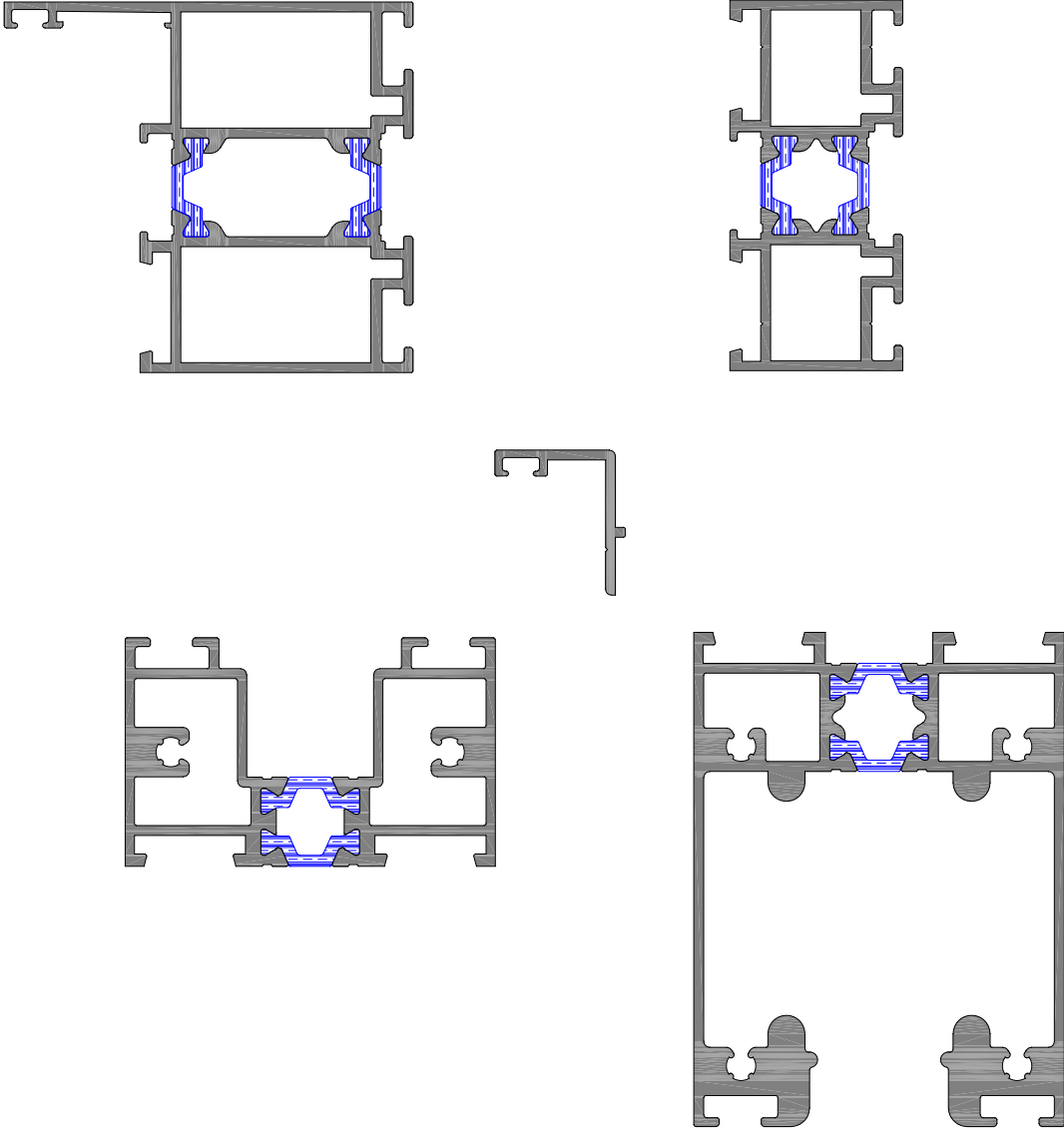

MAESTRO-60 Sliding Folding

BK-6014 BK-6010 BK-6008
MONTAJ DETAYI
INSTALLATION DETAIL

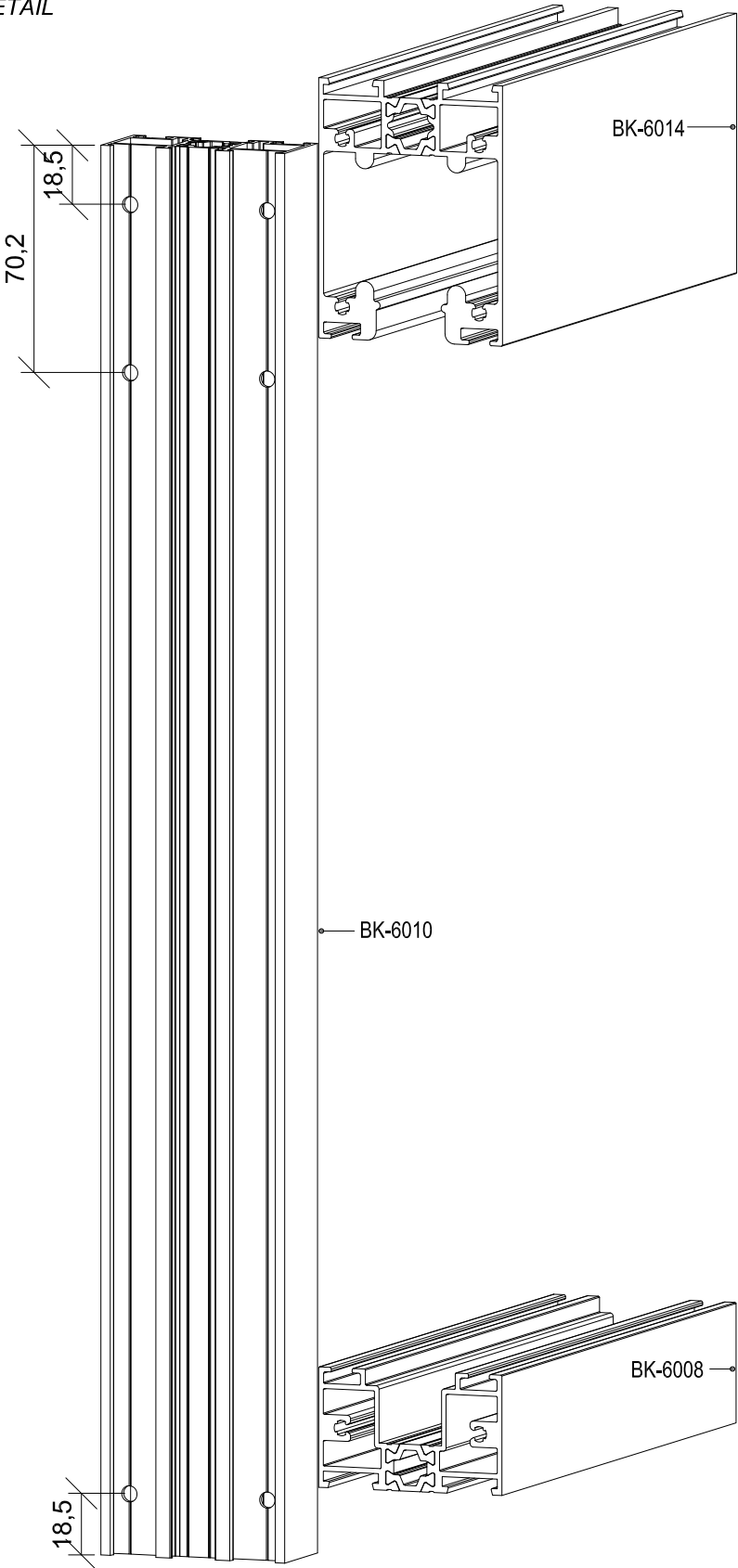

MAESTRO-60 Sliding Folding

BK-6009
KESİM DETAYI
CUTTING DETAIL

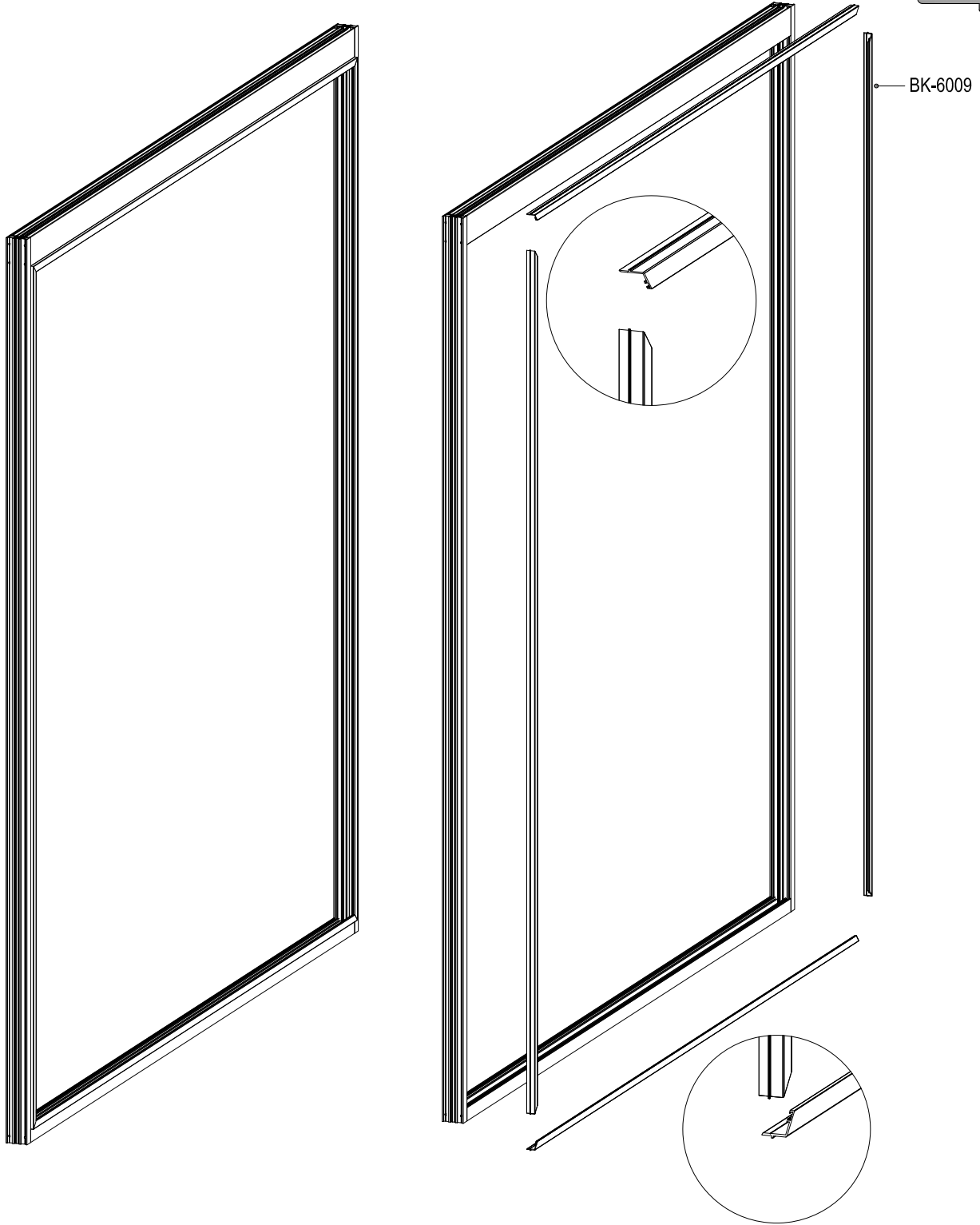
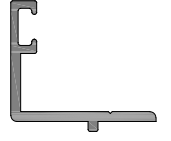

	2	BK-6009	YATAY DAMLALIK PR. / HORIZONTAL DRIP WEATHER PR.	L-53	45°/45°
	2	BK-6009	DÜŞEY DAMLALIK PR. / VERTICAL DRIP WEATHER PR.	H-113,8	45°/45°

MAESTRO-60 Sliding Folding

BK-6012

ÇALIŞIR KANAT KERTME DETAYI

SASH INTERLOCK END MILLING DETAIL

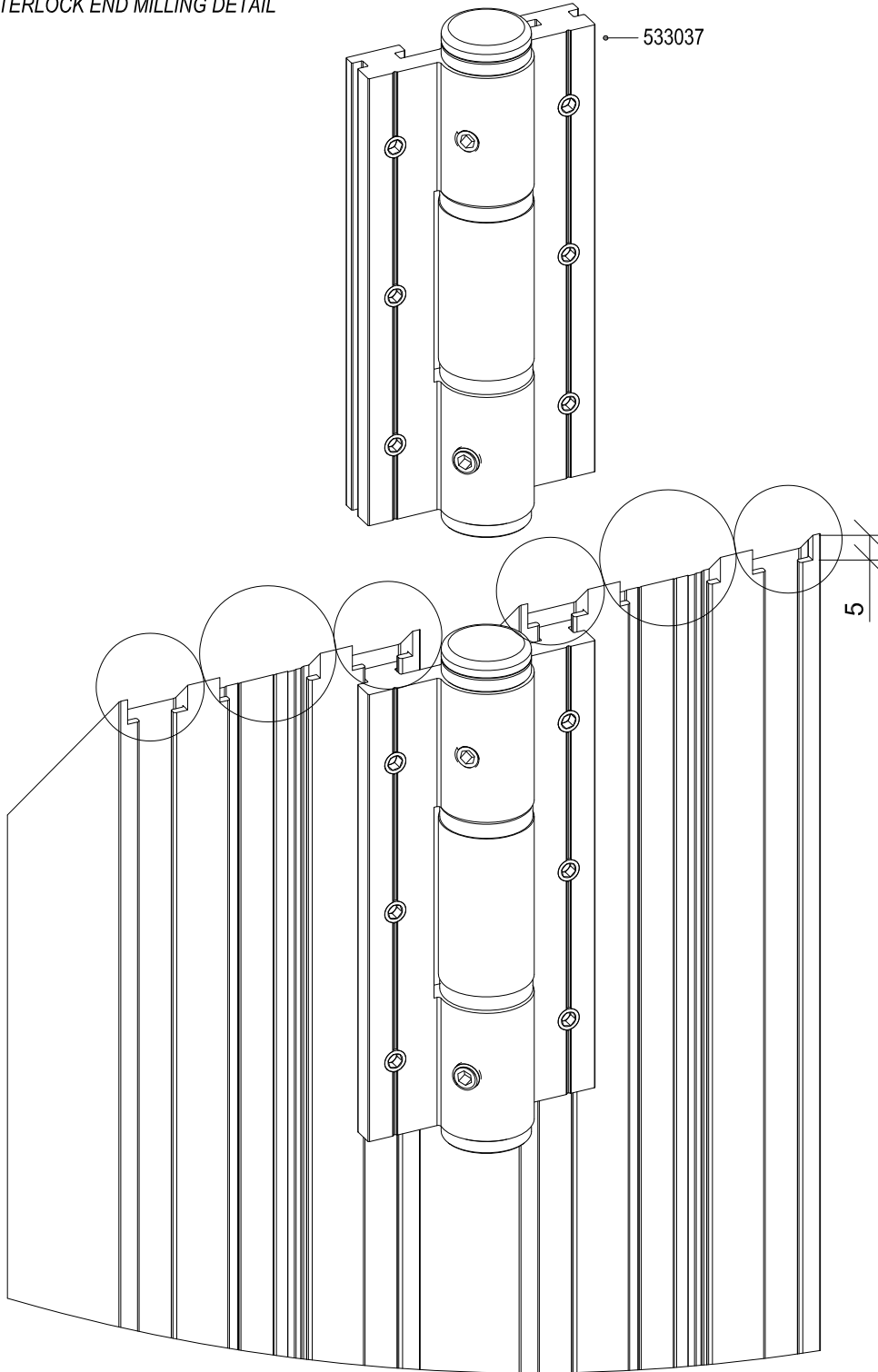

MAESTRO-60 Sliding Folding

BK-6012
ÇALIŞIR KANAT İŞEM DETAYI
SASH INTERLOCK END MILLING DETAIL

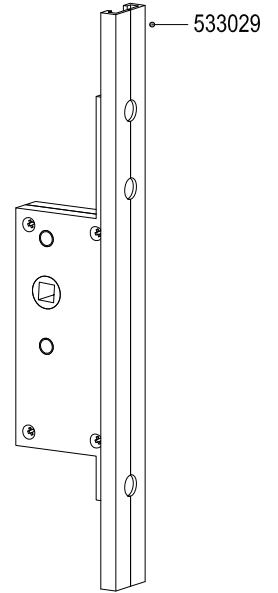
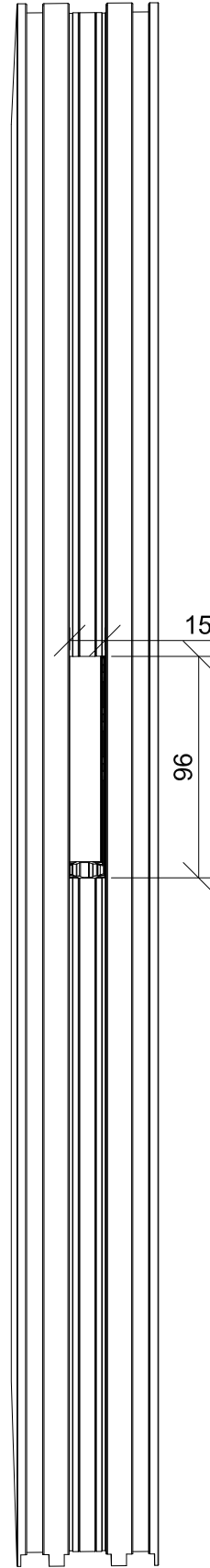
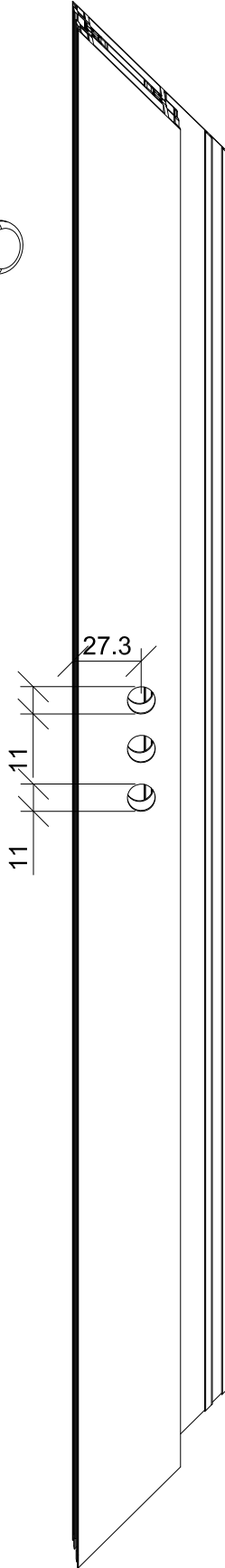
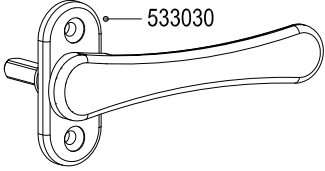

MAESTRO-60 Sliding Folding

BK-6012

ÇALIŞIR KANAT İŞEM DETAYI

SASH INTERLOCK END MILLING DETAIL

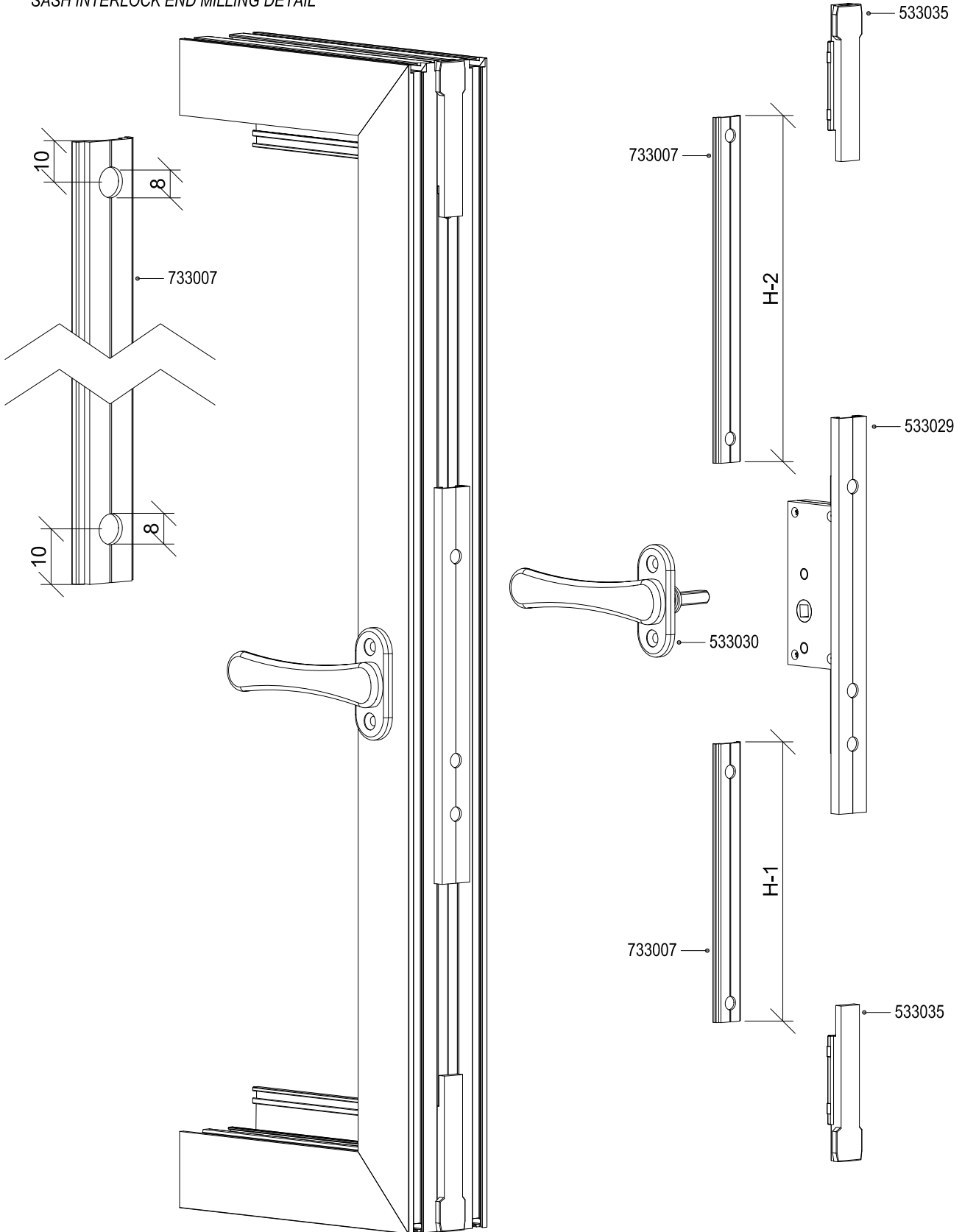

MAESTRO-60 Sliding Folding

BK-6012-212250

ÇALIŞIR KANAT İŞEM DETAYI
SASH INTERLOCK END MILLING DETAIL

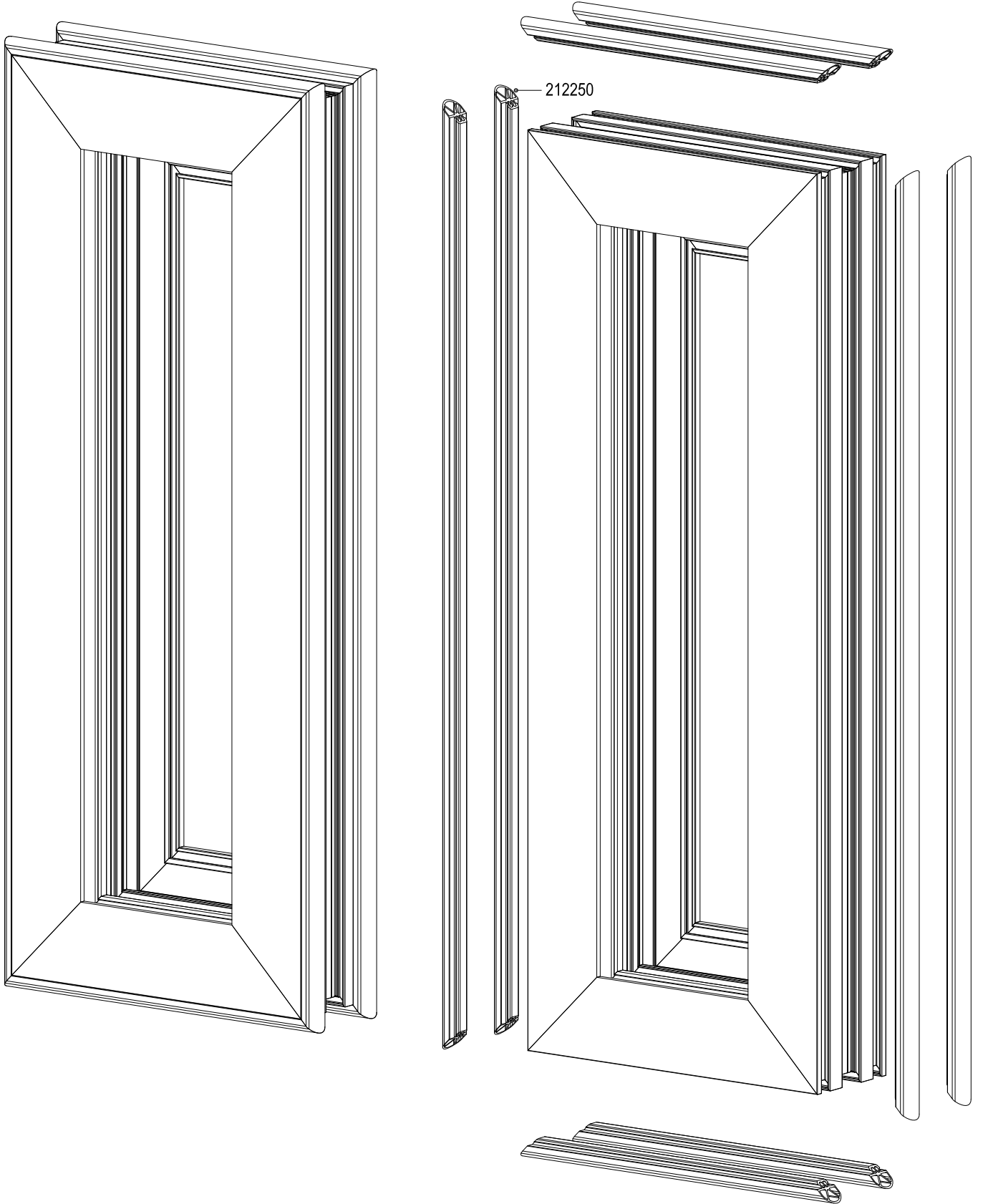

MAESTRO-60 Sliding Folding

BK-6012-BK-6008-212250-232024

ÇALIŞIR KANAT İŞEM DETAYI

SASH INTERLOCK END MILLING DETAIL

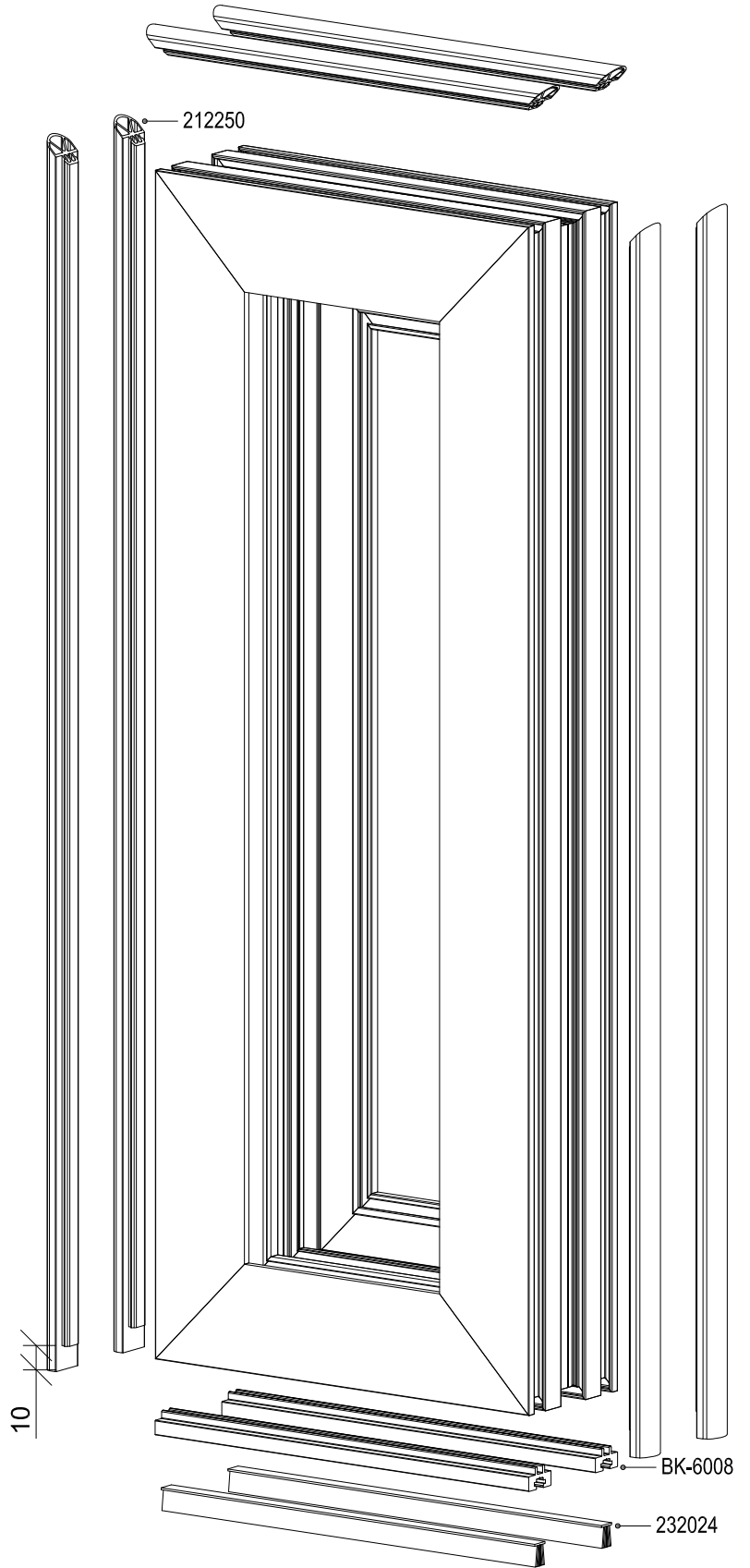
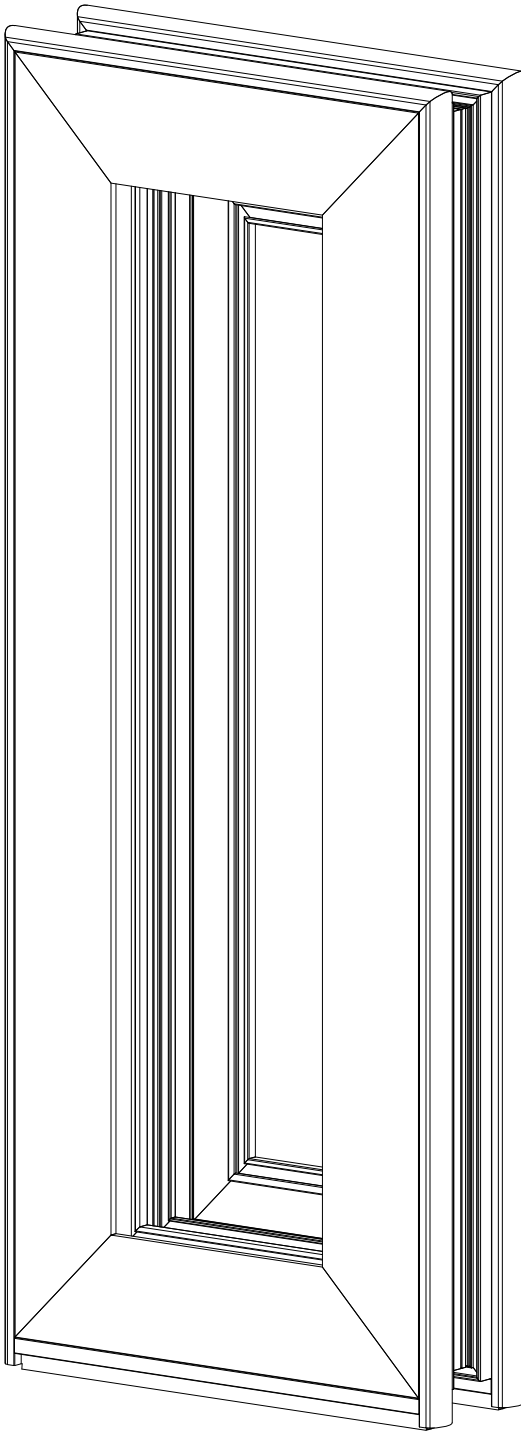

MAESTRO-60 Sliding Folding

OLUKLU KASA DETAYI
HIDDEN SUB FRAME

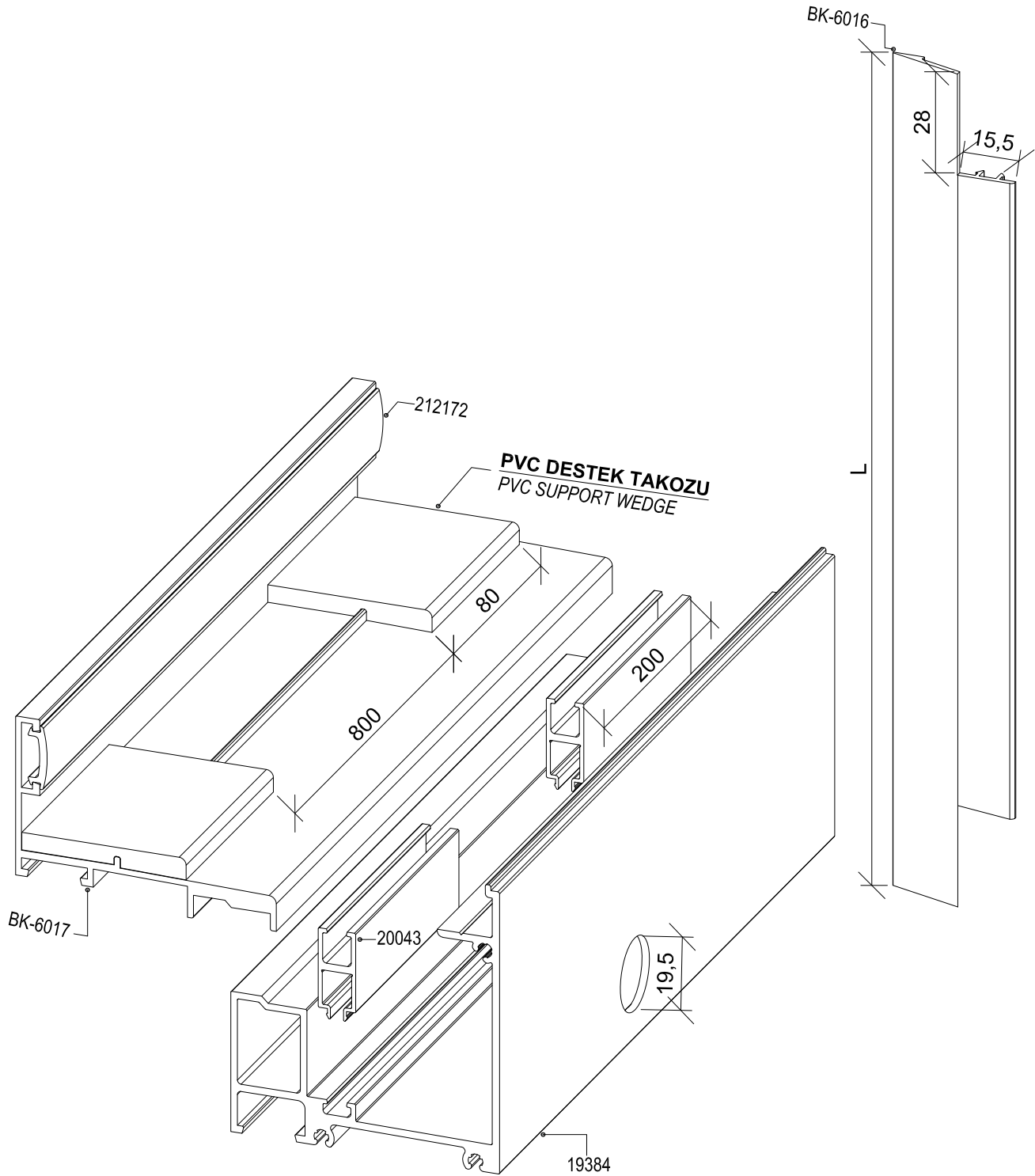

MAESTRO-60 Sliding Folding

OLUKLU KASA DETAYI HIDDEN SUB FRAME

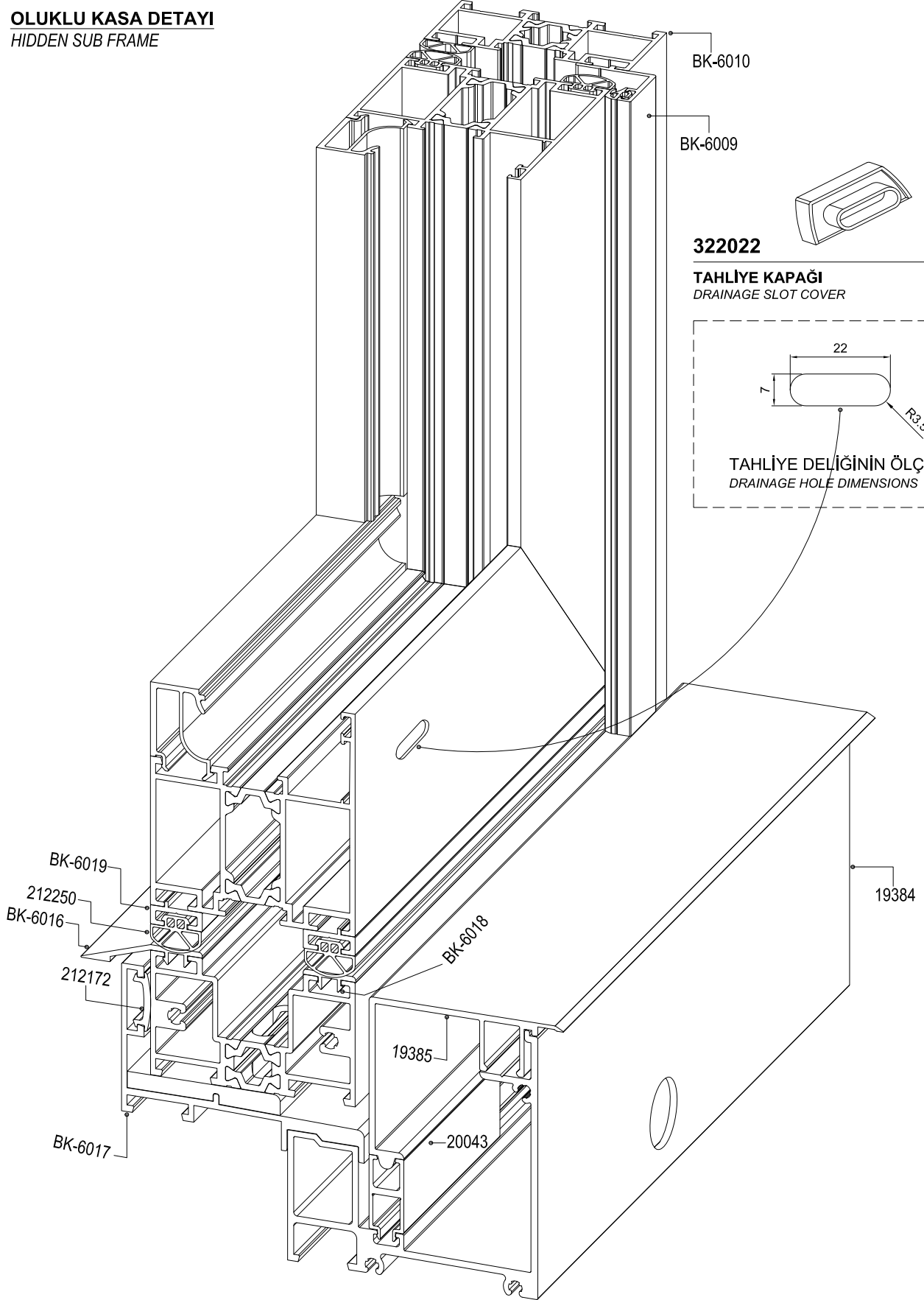

MAESTRO-60 Sliding Folding

BK-6012-212250

PVC PROFİL KESİM DETAYI

PVC PROFILE CUTTING DETAIL

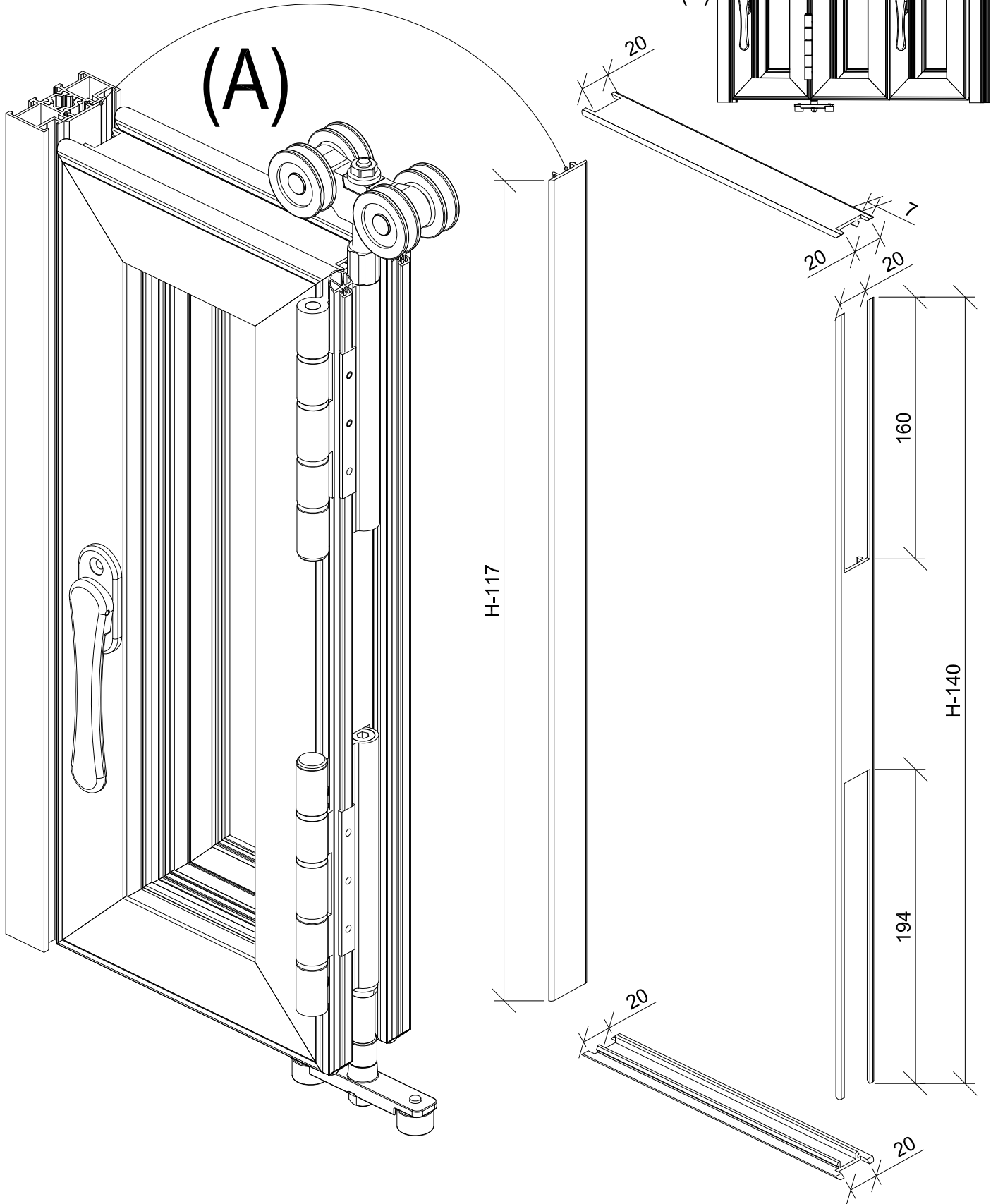

MAESTRO-60 Sliding Folding

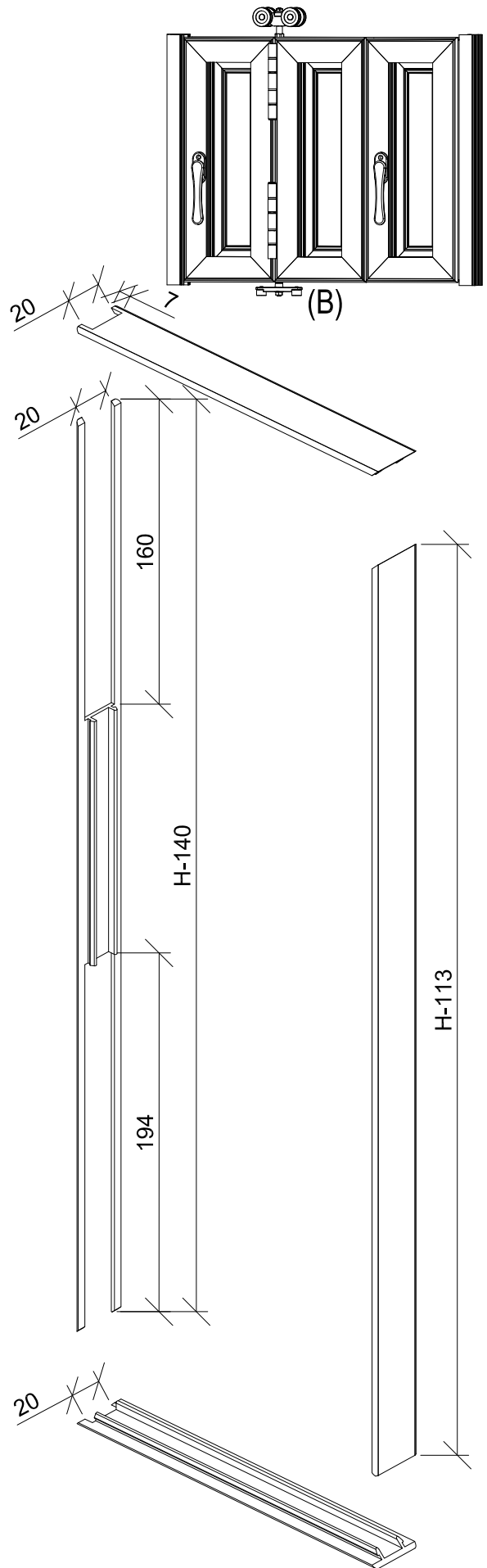
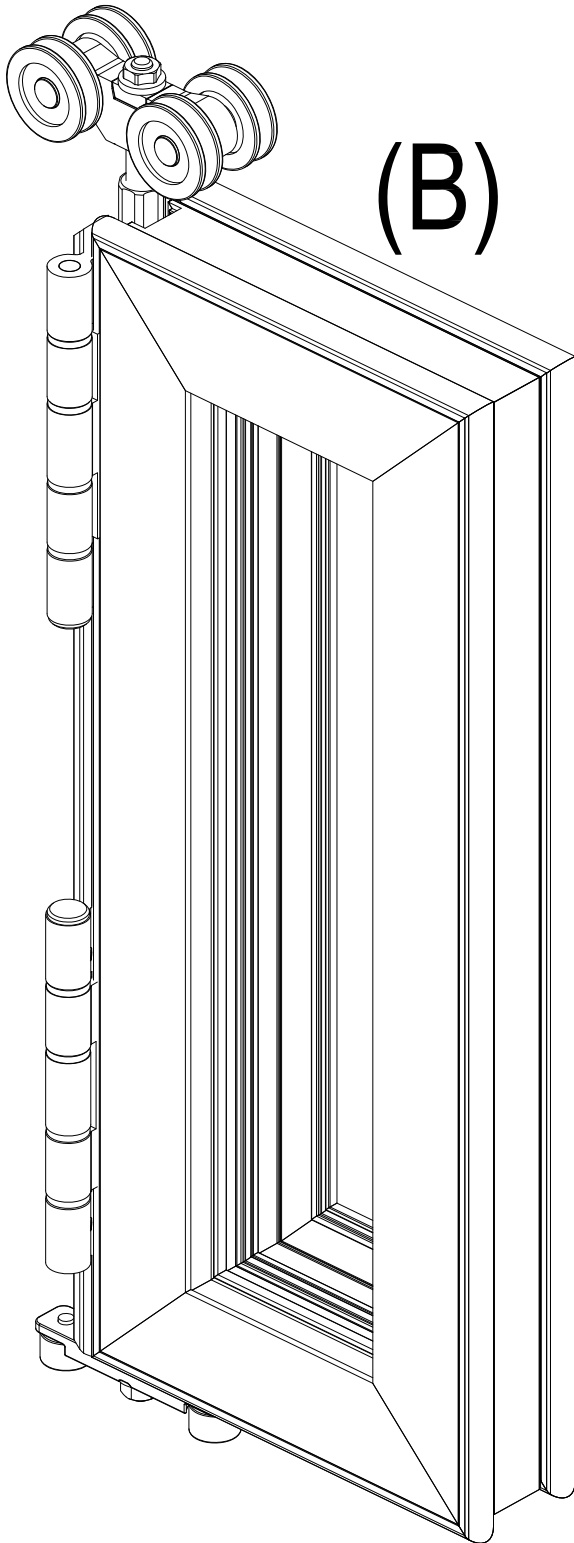

MAESTRO-60 Sliding Folding

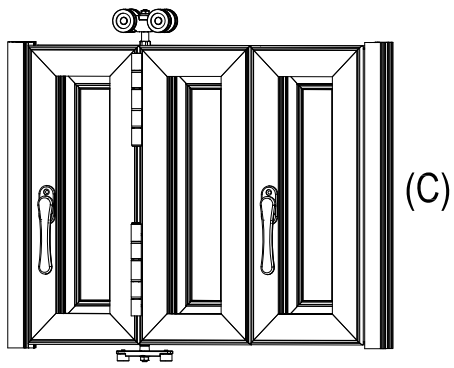

(C)

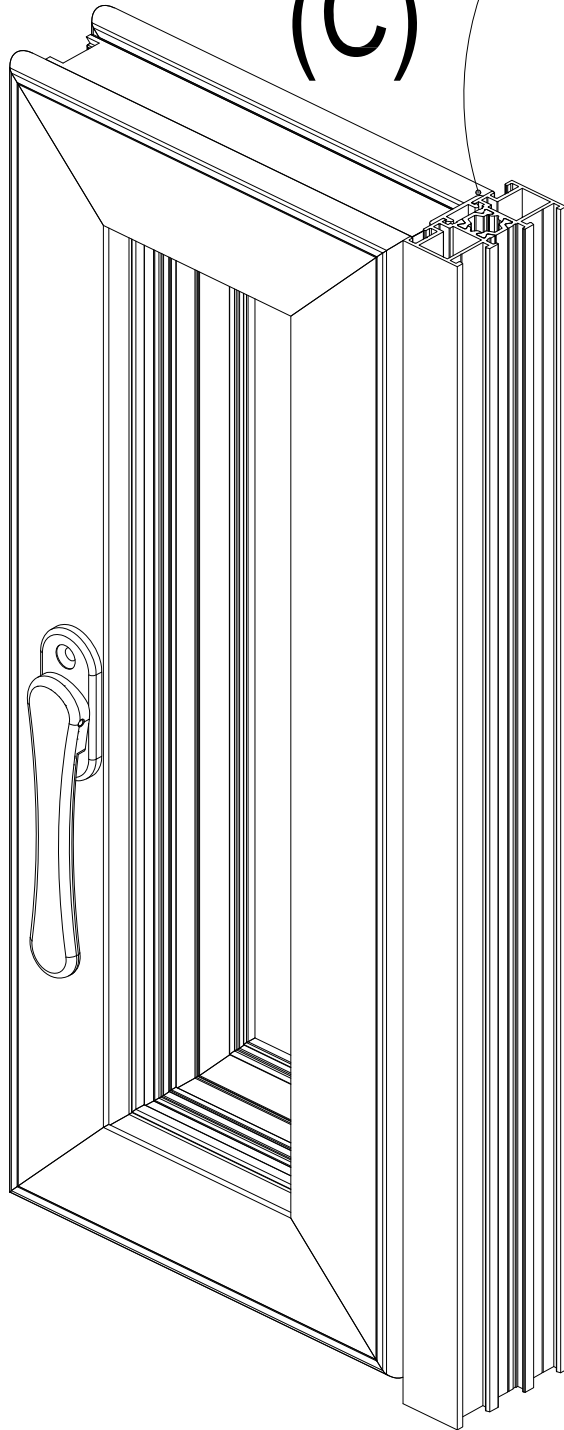
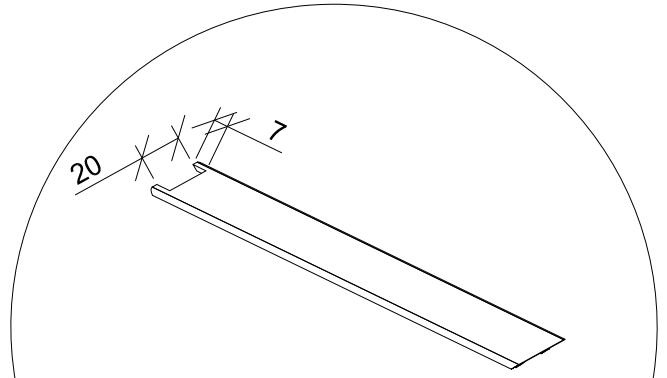

H-140

H-117

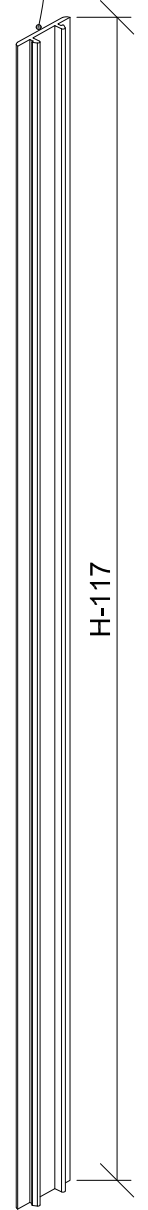
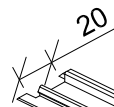

KESİM ÜRETİM ÖLÇÜLERİ

MANUFACTURING DIMENSIONS

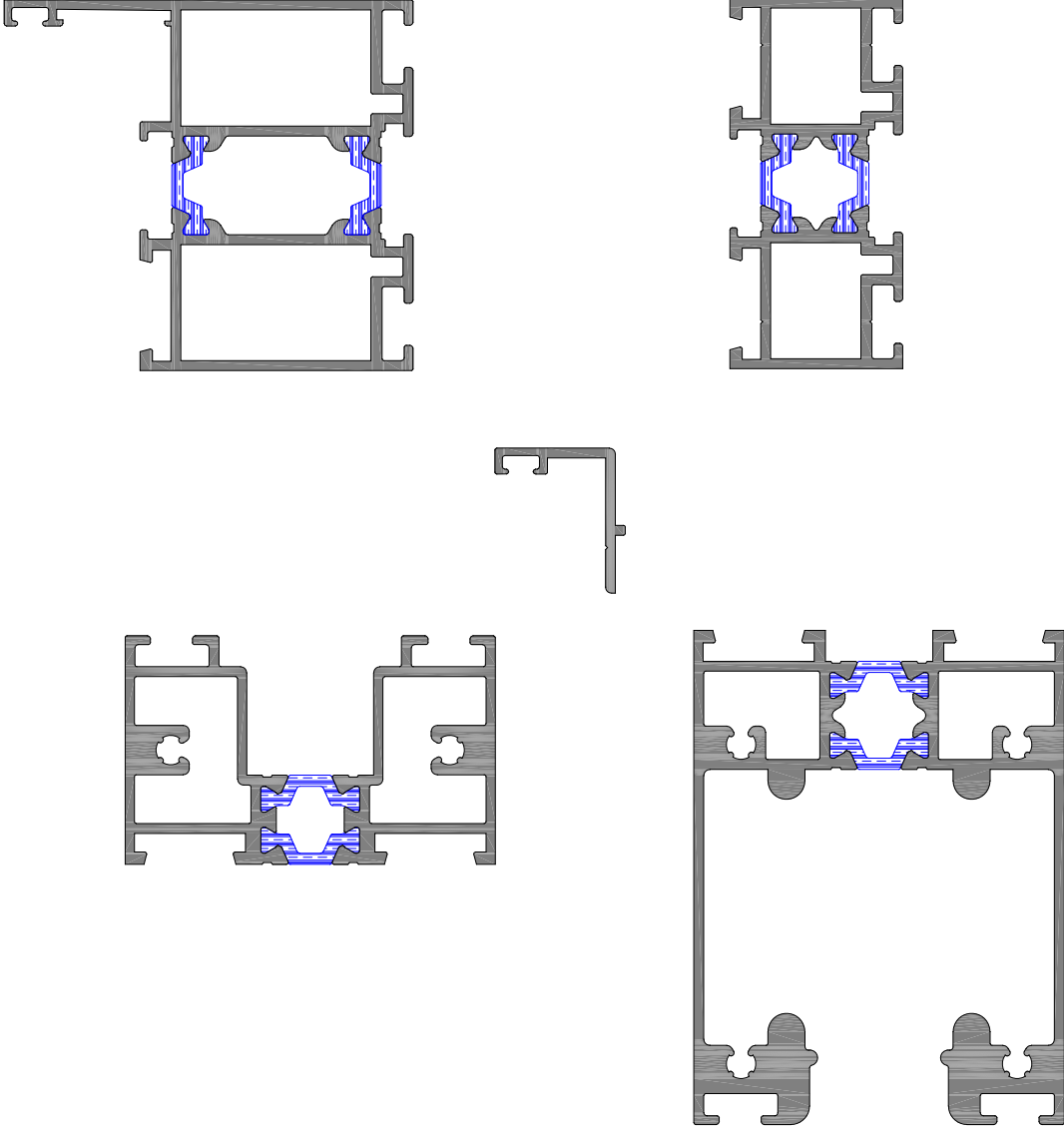

MAESTRO-60 Sliding Folding

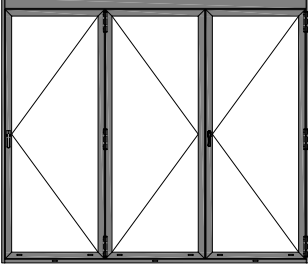

PROFİLLER / PROFILES

ÇİZİM UNIT	ADET UNIT	KOD CODE	TANIM DESCRIPTION	KESİM ÖLÇÜSÜ CUTTING SIZE	KESİM AÇISI CUTTING ANGLE
	1	BK-6014	ÜST KASA PR. / TOP FRAME PR.	L-56	90°/90°
	1	BK-6013	ALT KASA PR. / LOWER FRAME PR.	L-56	90°/90°
	2	BK-6010	DÜŞEY KASA PR. / VERTICAL FRAME PR.	L	90°/90°
	6	BK-6012	DÜŞEY KANAT PR. / VERTICAL SASH PR.	H - 144	45°/45°
	6	BK-6012	YATAY KANAT PR./ HORIZONTAL SASH PR.	L-110/3	45°/45°
	2	BK-6009	YATAY DAMLALIK PR. / HORIZONTA DRIP WHEATHER PR.	L-53	45°/45°
	2	BK-6009	DÜŞEY DAMLALIK PR. / VERTICAL DRIP WHEATHER PR.	H-113,8	45°/45°
	6	20412	YATAY CAM ÇITASI / HOR. GLAZING BEAD	L-110/3-88,4	90°/90°
	6	20412	YATAY CAM ÇITASI / HOR. GLAZING BEAD	H - 276,4	90°/90°

AKSESUARLAR / ACCESSORIES

ÇİZİM UNIT	ADET UNIT	KOD CODE	TANIM DESCRIPTION	KESİM ÖLÇÜSÜ CUTTING SIZE	KESİM AÇISI CUTTING ANGLE
	12	111319	KÖŞE TAKOZU / CORNER CLEAT	18,3(mm)	
	12	162010	KÖŞE ÇAVUŞU / CORNER ALIGNMENT	-	
	-	212307	DIŞ CAM FİTİLİ / OUTER GLAZING GASKET	2L +6H	
	-	212250	ORTA DERZ BALON FİTİLİ / MIDDLE JOINT BALLOON GASKET	6L +14H	
	-	212193	KAMA FİTİLİ / GASKET FOR GLAZING	2L + 6H	
	-	212276	KANAT BİNİ CONTASI / SASH SEALING GASKET	2L + 2H	
	12	332062	CAM TAKOZU / GLASS SUPPORT	-	
	1	533026	ALT KILAVUZ / LOWER GUIDE	-	
	1	533027	ÜST TAŞIYICI ARABA / TOP CARRIER GUIDE	-	
	1	533037	ÇEKME KOL İÇERİ AÇILIM / PULL HANDLE OPENING IN	-	
	7	533031	MENTEŞE / HINGE	-	
	2	533030	PENCERE KOLU WINDOW HANDLE	-	
	4	533035	ALT ÜST KİLİT / UPPER LOWER LOCK	-	
	2	533029	ÇİFT YÖNLÜ KİLİT / DOUBLE WAY LOCK	-	
	2	733037	POLYEMİDE T1J PR. /POLYEMİDE T1J PR.	H-120	
	4	BK-6012	DÜŞEY PVC KAPAMA PR. / VERTICAL PVC CLOSING PR.	H - 140	45°/45°
	6	BK-6012	YATAY PVC KAPAMA PR./ HORIZONTAL PVC CLOSING PR.	L-110/3+4	45°/45°

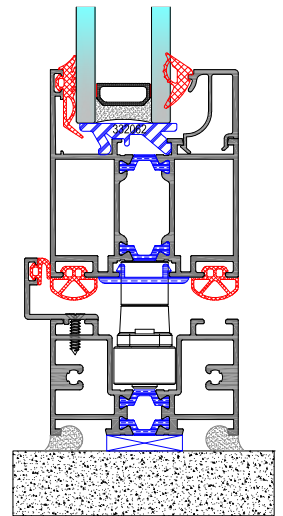
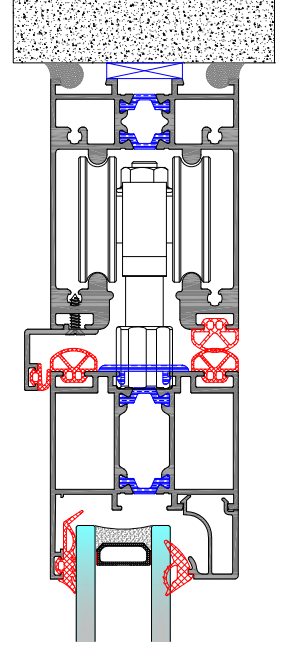

MAESTRO-60 Sliding Folding

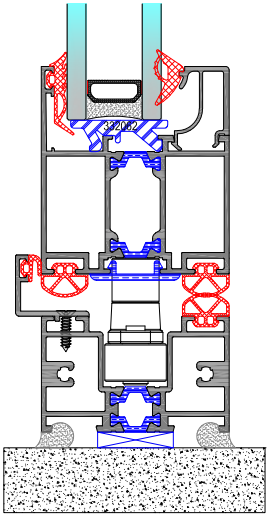
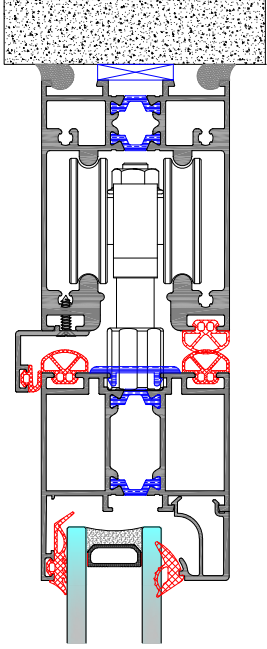
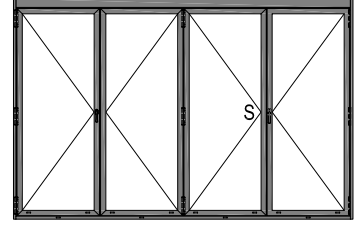

PROFİLLER / PROFILES

ÇİZİM UNIT	ADET UNIT	KOD CODE	TANIM DESCRIPTION	KESİM ÖLÇÜSÜ CUTTING SIZE	KESİM AÇISI CUTTING ANGLE
	1	BK-6014	ÜST KASA PR. / TOP FRAME PR.	L-56	90°/90°
	1	BK-6013	ALT KASA PR. / LOWER FRAME PR.	L-56	90°/90°
	2	BK-6010	DÜŞEY KASA PR. / VERTICAL FRAME PR.	L	90°/90°
	8	BK-6012	DÜŞEY KANAT PR. / VERTICAL SASH PR.	H - 144	45°/45°
	8	BK-6012	YATAY KANAT PR./ HORIZONTAL SASH PR.	L-123,5/4	45°/45°
	2	BK-6009	YATAY DAMLALIK PR. / HORIZONTAL DRIP WEATHER PR.	L-53	45°/45°
	2	BK-6009	DÜŞEY DAMLALIK PR. / VERTICAL DRIP WEATHER PR.	H-113,8	45°/45°
	8	20412	YATAY CAM ÇITASI / HOR. GLAZING BEAD	L-123,5/4-88,4	90°/90°
	8	20412	YATAY CAM ÇITASI / HOR. GLAZING BEAD	H - 276,4	90°/90°
	1	BK-6009	DÜŞEY DAMLALIK PR. / VERTICAL DRIP WEATHER PR.	H - 155	90°/90°

AKSESUARLAR / ACCESSORIES







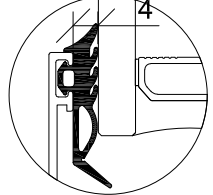

ÇİZİM UNIT	ADET UNIT	KOD CODE	TANIM DESCRIPTION	KESİM ÖLÇÜSÜ CUTTING SIZE	KESİM AÇISI CUTTING ANGLE
	16	111319	KÖŞE TAKOZU / CORNER CLEAT	18,3(mm)	
	16	162010	KÖŞE ÇAVUŞU / CORNER ALIGNMENT	-	
	-	212307	DIŞ CAM FİTİLİ / OUTER GLAZING GASKET	2L + 8H	
	-	212250	ORTA DERZ BALON FİTİL / MIDDLE JOINT BALLOON GASKET	6L + 17H	
	-	212193	KAMA FİTİLİ / GASKET FOR GLAZING	2L + 8H	
	-	212276	KANAT BİNI CONTASI / SASH SEALING GASKET	2L + 3H	
	16	332062	CAM TAKOZU / GLASS SUPPORT	-	
	1	533026	ALT KILAVUZ / LOWER GUIDE	-	
	1	533027	ÜST TAŞIYICI ARABA / TOP CARRIER GUIDE	-	
	1	533037	ÇEKME KOL İÇERİ AÇILIM / PULL HANDLE OPENING IN	-	
	10	533031	MENTEŞE / HINGE	-	
	2	533030	PENCERE KOLU WINDOW HANDLE	-	
	4	533035	ALT ÜST KİLİT / UPPER LOWER LOCK	-	
	2	533029	ÇİFT YÖNLÜ KİLİT / DOUBLE WAY LOCK	-	
	2	733037	POLYEMİDE TİJ PR. / POLYEMİDE TIJ PR.	H-120	
	2	742010	GİZLİ TELLİ KİLİT / HIDDEN STEEL LOCK	-	
	4	BK-6012	DÜŞEY PVC KAPAMA PR. / VERTICAL PVC CLOSING PR.	H - 140	45°/45°
	6	BK-6012	YATAY PVC KAPAMA PR./ HORIZONTAL PVC CLOSING PR.	L-123,5/4+4	45°/45°

MAESTRO-60 Sliding Folding

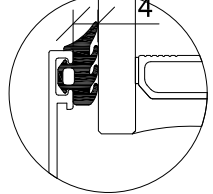
EPDM FİTİLLER / EPDM GASKETS		
ÇİZİM / DRAWING	AKSESUAR KODU VE ÜRÜN BİLGİLERİ / ACCESSORY CODE AND PRODUCT DESCRIPTION	TAKILMA BÖLGESİ / APPLICATION AREA
	212153 KAMA FİTİLİ 3 mm / SUPPORT GASKET 3 mm BİRİM AĞIRLIK / UNIT WEIGHT: 42 g/m KOLİ MİKTARI / PACKAGE QUANTITY: 350 m	
	212154 KAMA FİTİLİ 4 mm / SUPPORT GASKET 4 mm BİRİM AĞIRLIK / UNIT WEIGHT: 55 g/m KOLİ MİKTARI / PACKAGE QUANTITY: 270 m	
	212155 KAMA FİTİLİ 5 mm / SUPPORT GASKET 5 mm BİRİM AĞIRLIK / UNIT WEIGHT: 65 g/m KOLİ MİKTARI / PACKAGE QUANTITY: 230 m	
	212193 KAMA FİTİLİ 6 mm / SUPPORT GASKET 5 mm BİRİM AĞIRLIK / UNIT WEIGHT: 89 g/m KOLİ MİKTARI / PACKAGE QUANTITY: 170 m	
	212339 KAMA FİTİLİ 7 mm / SUPPORT GASKET 7 mm BİRİM AĞIRLIK / UNIT WEIGHT: 94 g/m KOLİ MİKTARI / PACKAGE QUANTITY: 155 m	
	212250 ORTA DERZ BALON FİTİL / MIDDLE JOINT BALLOON GASKET BİRİM AĞIRLIK / UNIT WEIGHT: 0,75 g/m KOLİ MİKTARI / PACKAGE QUANTITY: 100 m	
	232024 PERDELİ FIRÇA FİTİL 69X700 / WEATHER STRIP BRUSH KOLİ MİKTARI / PACKAGE QUANTITY: 450 m	

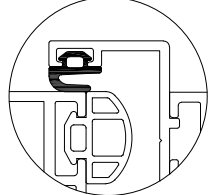
MAESTRO-60 Sliding Folding

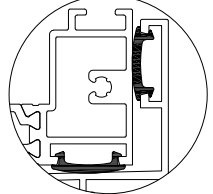
EPDM FİTİLLER / EPDM GASKETS

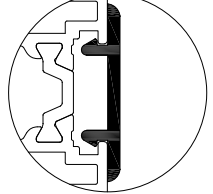
ÇİZİM / DRAWING	AKSESUAR KODU VE ÜRÜN BİLGİLERİ / ACCESSORY CODE AND PRODUCT DESCRIPTION	TAKILMA BÖLGESİ / APPLICATION AREA
	212307 DIŞ CAM FİTİLİ 4 mm / OUTER GLAZING GASKET 4 mm BİRİM AĞIRLIK / UNIT WEIGHT: 88 g/m KOLİ MİKTARI / PACKAGE QUANTITY: 170 m	
	212168 DIŞ CAM FİTİLİ 4 mm / OUTER GLAZING GASKET 4 mm BİRİM AĞIRLIK / UNIT WEIGHT: 68 g/m KOLİ MİKTARI / PACKAGE QUANTITY: 220 m	
	212276 Kanat BİNE FİTİLİ / CLAMP CONNECTION GASKET BİRİM AĞIRLIK / UNIT WEIGHT: 31 g/m KOLİ MİKTARI / PACKAGE QUANTITY: 400 m	
	212172 KAPATMA FİTİLİ / CLOSING GASKET BİRİM AĞIRLIK / UNIT WEIGHT: 52 g/m KOLİ MİKTARI / PACKAGE QUANTITY: 250 m	
	332120 PVC KAPAMA PROFİLİ / PVC CLOSING PROFILE	

MAESTRO-60 Sliding Folding

533035
ALT ÜST KİLİT
UPPER LOWER LOCK

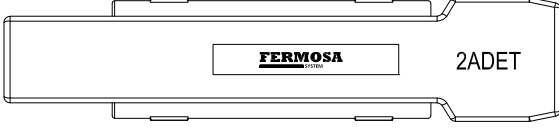

742010
GİZLİ TELLİ KİLİT
HIDDEN STEEL LOCK



533029
ÇİFT YÖNLÜ KİLİT
DOUBLE WAY LOCK

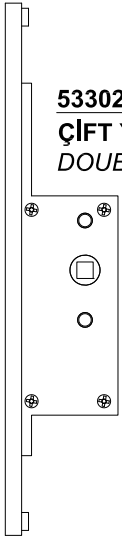

533030
PENCERE KOLU
WINDOW HANDLE



533037
ÇEKME KOL İÇERİ AÇILIM
PULL HANDLE OPENING IN

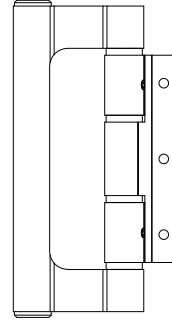

533033
ÇEKME KOL DIŞARI AÇILIM
PULL ARM OPENING OUT

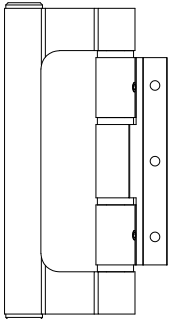

533031
MERKEZ MENTEŞE
CENTER HINGE

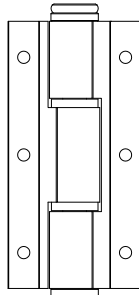

512043
PENCERE KOLU
WINDOW HANDLE

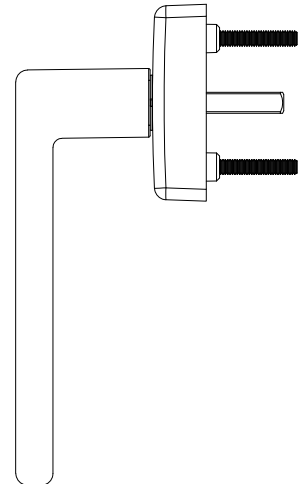

MAESTRO-60 Sliding Folding

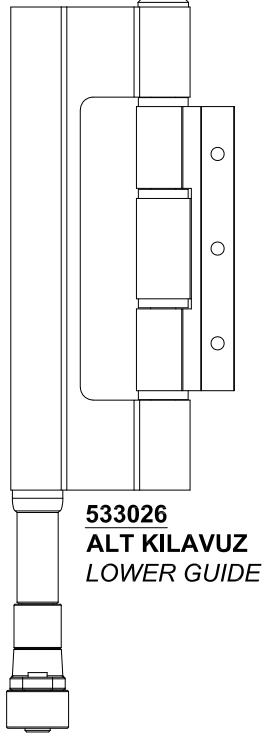

533026
ALT KILAVUZ
LOWER GUIDE

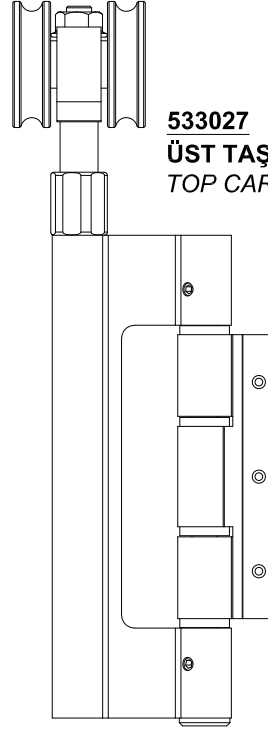

533027
ÜST TAŞIYICI ARABA(75kg)
TOP CARRIER GUIDE(75kg)

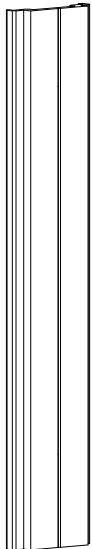

733007
POLYAMİD TİJ
POLYAMIDE CONNECTION ROD

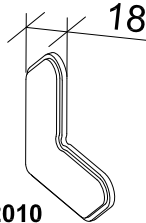

162010
KÖŞE ÇAVUŞU - 1 (Polyamid)
CORNER ALIGNMENT - 1

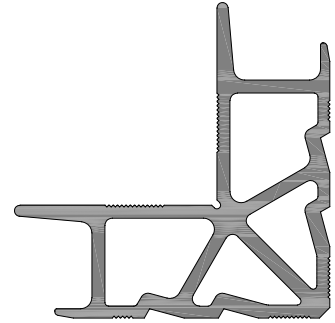

111319
KÖŞE TAKOZU(18,3mm)
CORNER CLEAT(18,3mm)

MAESTRO-60 Sliding Folding

KAPI KİLİTLEME SETİ DOOR LOCKING KIT

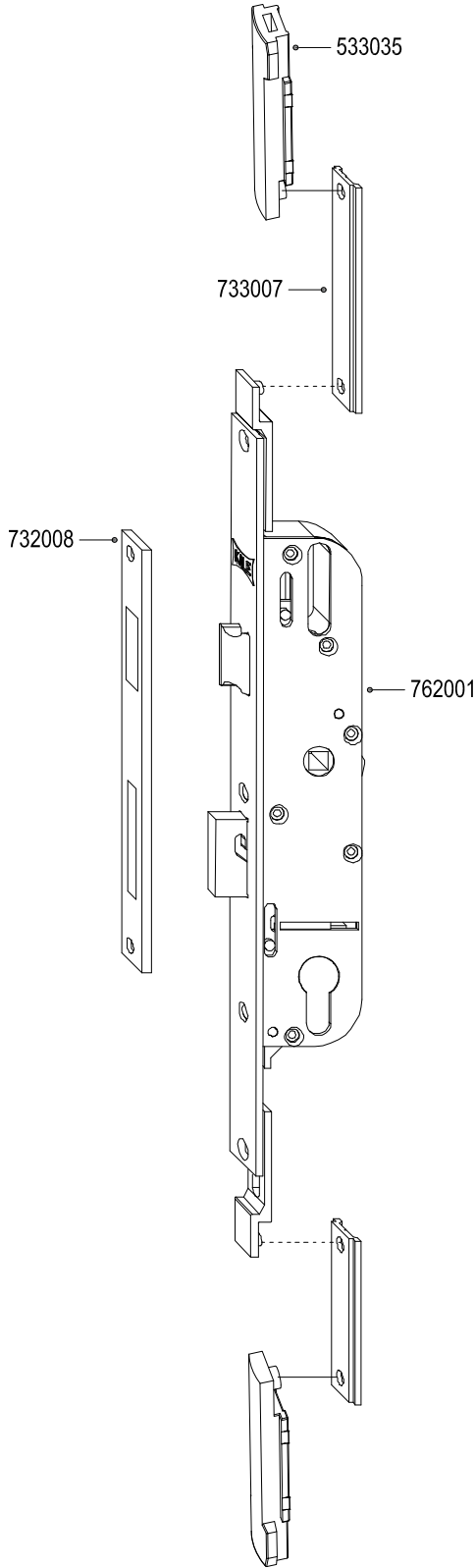

**TABLO-1A: BİNİLİ KAPILAR İÇİN
İÇTEN VE DIŞTAN MÜDAHELELİ KİLİT**
TABLE -1A: INWARD & OUTWARD
INTERFERENCED LOCK FOR STEP HINGE DOORS

KOD	ÜRÜN
762001	KİLİT MEKANİZMASI LOCKING MECHANISM
733007	POLYAMİD TİJ POLYAMIDE CONNECTION ROD
530035	ALT ÜST KİLİT UPPER LOWER LOCK
732008	KİLİT KARŞILIĞI STRIKER FOR MORTISE LOCK

MAESTRO-60 Sliding Folding

322100
KANAT STOPLAYICI
SASH STOPPER

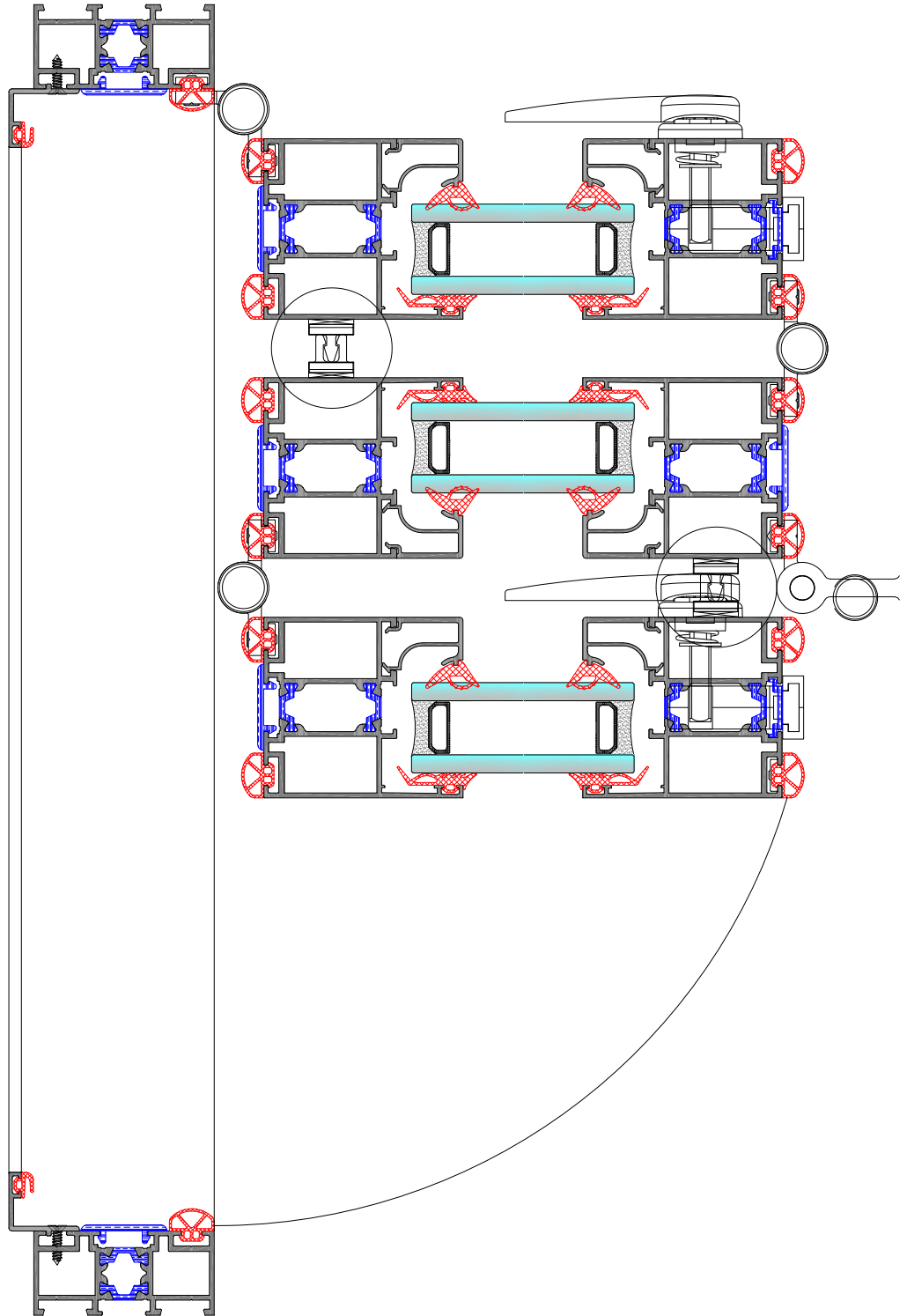
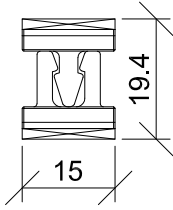

MAESTRO-60 Sliding Folding

TEKNİK ÖZELLİKLER / TECHNICAL PROPERTIES

Alüminyum profil üretim tesisimiz **ISO 9001** , **ISO 14001** , **ISO 18001** kalite güvence belgelerine sahiptir.

1-Profil Hammaddesi (*Raw Material*) : AA 6063 (AlMgSi 0.5 F22) , **EN 573-3**

2-Mekanik Özellikler (*Mechanical Properties*) : **EN 755-2**

Elastisite Modülü (*Elasticity Modul*) : 7000 kN/cm²

Kopma Mukavemeti (*Yield Strenght*) : 215 N/mm²

Akma Mukavemeti (*Flow Strenght*) : 160 N/mm²

Uzama (*Elongation*) : minimum 6 %

Sertlik (*Hardness*) : 70 HRB

3-Bariyer Hammaddesi

a-PA 66 GF 25 (25 % cam elyaf takviyeli polyamid) (*25 % the manufactured from glass stiffened polyamid*): Elokسال ve toz boya işleminden **önce** yerleştirilir. (*Placed into the aluminium profiles **before** anodic oxidation and powder coating.*)

b- PVC :

Elokسال ve toz boya işleminden **sonra** yerleştirilir. (*Placed into the aluminium profiles **after** anodic oxidation and powder coating.*)

PVC bariyerler, Polyamid bariyerlere göre 10 % daha ağırdır. (*PVC insulation bars are 10 % heavier than Polyamid insulation bars .*)

4-Elokسال (*Anodic Oxidation*)

Elokسالı Ürünler için Teknik Resim Standardı : **DIN 17611** , **EN 12371-1 (QUALANOD)**
(*The Standarts of Technical Delivery Terms Regarding Eloxal Products*)

Elokسال Tabakasının Kalınlığı (*Thickness of Eloxal Coating*): 10-15 mikron, **EN ISO 2360**

Daldırma ve Renklendirme Standardı (*The Standarts of Immersion Coloring*) : **DIN 50018**

Tesbit İşlemi Standardı (*Sealing Standarts*) : **EN 12373-5** , **ISO 3210 (TS 2676)**

5-Toz Boya Standartları (*The Standarts of Powder Coating*)

Kalınlık (*Thickness*) : min. 60 mikron

Adhezyon (*Adhesion*) : **EN ISO 2409**

Esneklik (*Elasticity*) : **EN ISO 1519**

Deformasyon (*Deformation*) : **EN ISO 6272-1**

Sertlik (*Hardness*) : **EN ISO 2815**

6-Yüzey Görünümü (*Surface Appearance*) : Gözle yapılacak kontrolde,yüzey üzerinde kaplanmış alan,çizik,pütürlük,kabarıklık,leke,soyulma vb. hatalar görülmemelidir. (*By visual observation,there has been no defects seen on the surface,such as scratches cramped shapes,swellings,stain etc. on the exposed areas.*)

7-Tüm Fitiller (*All gaskets*)

Hammadde (*Raw material*) : EPDM

Derz fitilleri hammaddesi (*Raw material of Gaskets for suture*) : Silikon (*Silicone*)

Ölçü Toleransları Standardı (*Measurement Tolerances Standarts*) : **DIN ISO 3302-1/E2**

Kalite Kontrol Standardı (*Quality Control Standart*) : **RAL-GZ 716**

8-Profil Tasarım ve Üretimindeki Ölçü Toleransları Standartları : **EN 12020-2** , **EN 755-9**

(*Measurement Tolerances Standarts for Profile Design and Manufacturing*)

FERMOsa



SYSTEM



www.burak.com.tr

Burak Alüminyum San. Tic. A.Ş.

Yeni Mah. 15th St. No: 3, TR-39780
Büyükkarşıran / Lüleburgaz / Turkey

 /burakaluminyum
 /burak.aluminyum
 /burakaluminyum

Phone : + 90 212 444 37 40
E-mail : info@burak.com.tr