

[ *types of packaging* ]





#### **WHY PACKAGING IS SO IMPORTANT?**

*Being expert in production of excellent quality is very important but not sufficient. For the fact that customers need and ask perfect material in their hand, we as suppliers have to care handling and transportation as well. The surface of Aluminium is quite sensitive, must be well protected to avoid damages.*

*Burak Alüminyum, with its deep experience in extrusions, gives highest importance to Packaging by using appropriate material combined with correct labourship. For a safe Packaging we consider the distance from factory to final destination, mode of transportation, vehicle to be used, as well as seasonal weather conditions.*

#### **WHAT TYPE OF PACKAGING?**

*For the safest delivery it is crucial to choose the right type of Packaging. We offer various alternatives for land, sea and air transportation. It is also important to decide on the optimum type in order to avoid extra cost for exaggerations. In this catalogue, you can find our most commonly used packaging alternatives. Please consult to our experts if you need any assistance to have the right Packaging type.*

*We also welcome special requirements of our customers. As Burak Aluminium, we are confident to claim that we are very experienced about packaging, and can answer all of our customers' needs.*





## 1. SEPARATORS

● **SEP-0**

*WITHOUT SEPERATOR*



● **SEP-1**

*TISSUE LAYER (PAPER / NYLON)*



● **SEP-2**

*CRAFT PAPER LAYER*



● **SEP-3**

*CARDBOARD OR WOOD STRIPS*



● **SEP-4**

*TISSUE INTERLEAVING (PAPER / NYLON)*

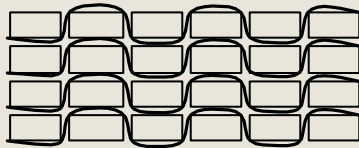

● **SEP-5**

*TISSUE INTERLEAVING AND LAYER (PAPER / NYLON)*

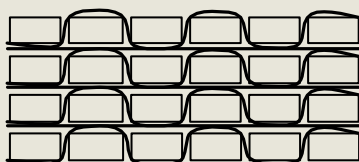

## 2. PACKETS

● **PAC-1**

*NYLON WRAPPING*

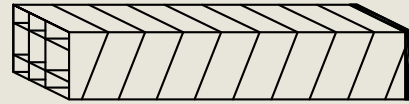

● **PAC-2**

*CREPE PAPER WRAPPING*

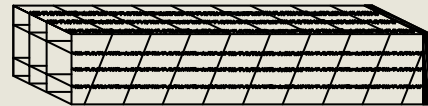

● **PAC-3**

*TAPE STRIPS*



● **PAC-4**

*CARDBOARD TUBE*



● **PAC-5**

*CARDBOARD FOLDING*

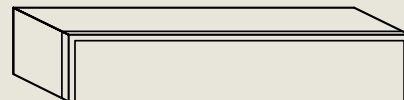

● **PAC-6**

*STRETCH PACK*





### 3. PALLETS

- **PAL-1**  
*CARDBOARD SEMI PLATFORM*

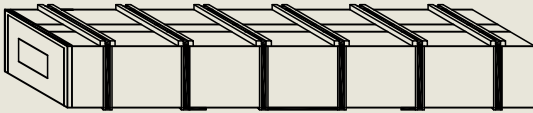

- **PAL-5**  
*EURO PALLET*

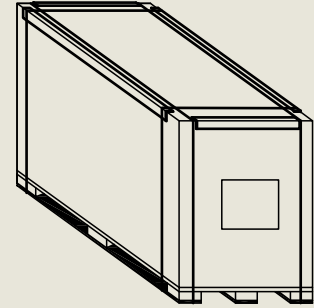

- **PAL-2**  
*CARDBOARD FULL PLATFORM*

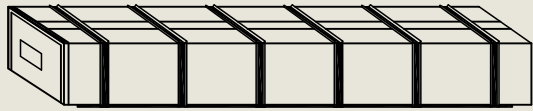

- **PAL-6**  
*CARDBOARD FOLDING WITH STRIPS*

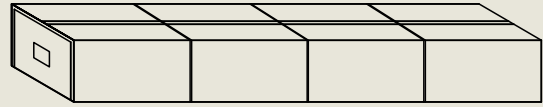

- **PAL-3**  
*BARE SEMI PLATFORM*

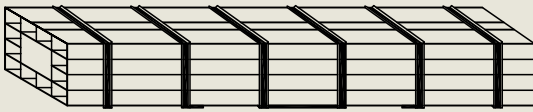

- **PAL-7**  
*WOODEN CRATE*

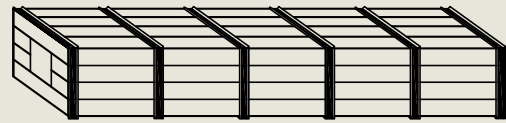

- **PAL-4**  
*BARE FULL PLATFORM*

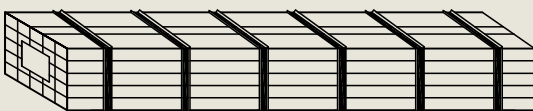

- **PAL-8**  
*WOODEN CAGE*



**SEP-0**

**WITHOUT SEPERATOR**

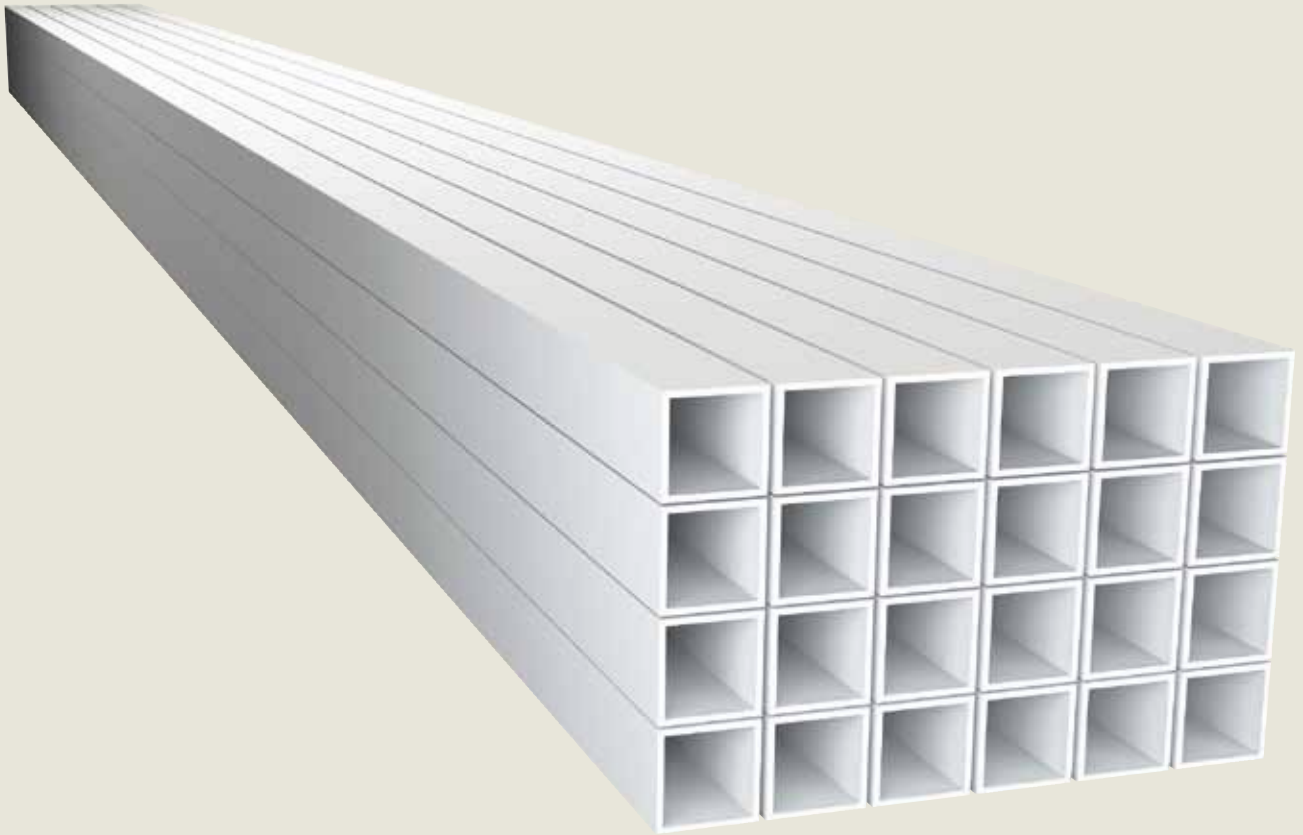

PROFILE

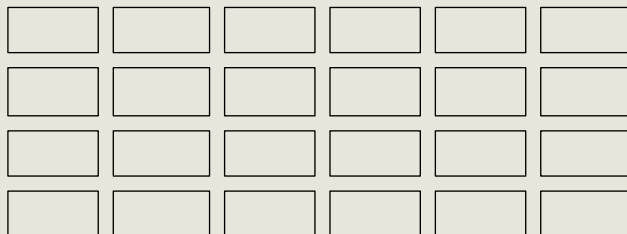

**SEP-1**

**TISSUE LAYER (PAPER / NYLON)**

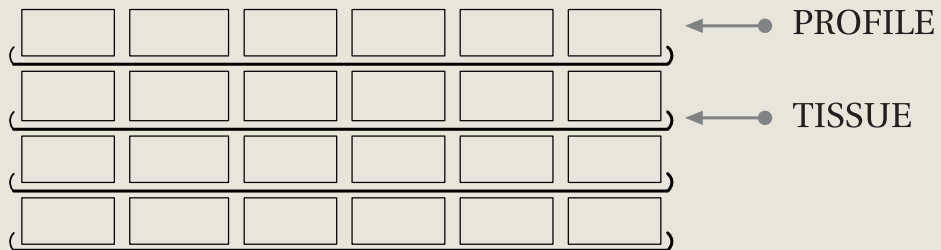
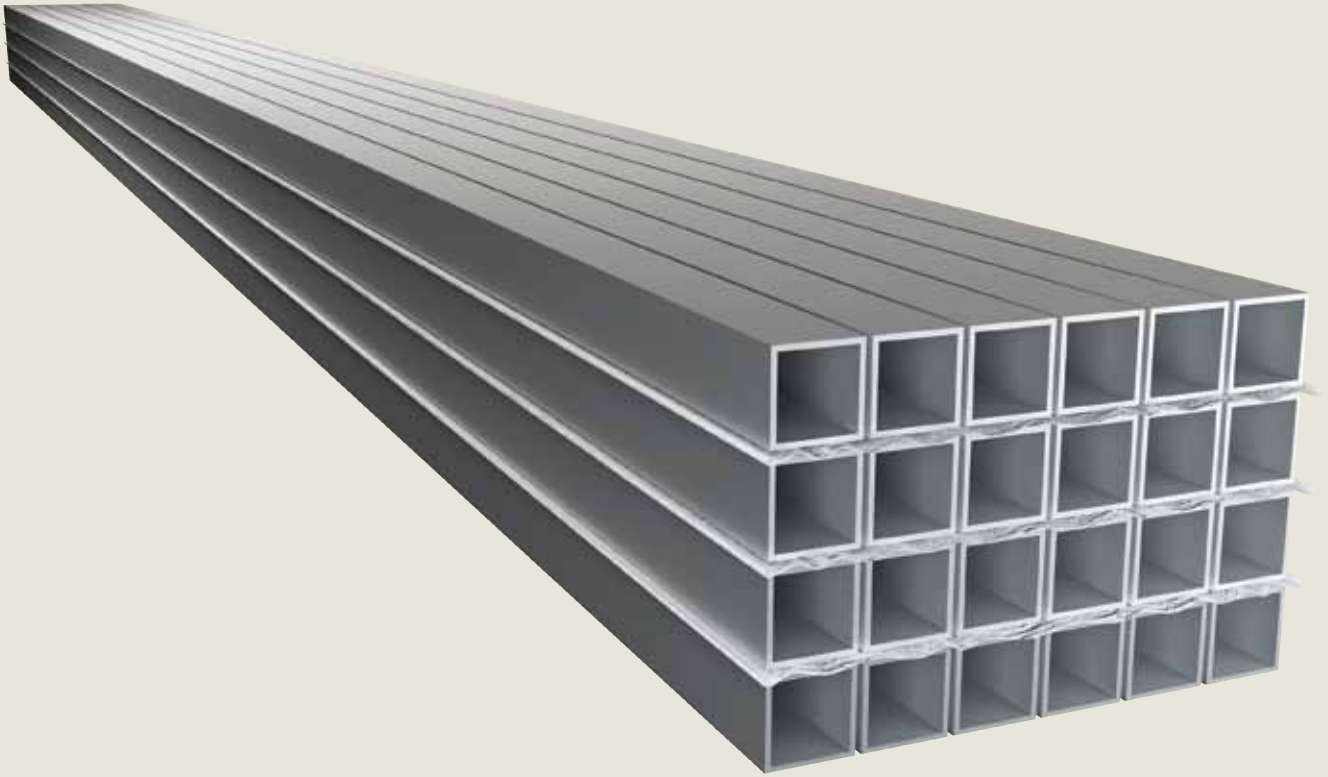



**SEP-2**

**CRAFT PAPER LAYER**

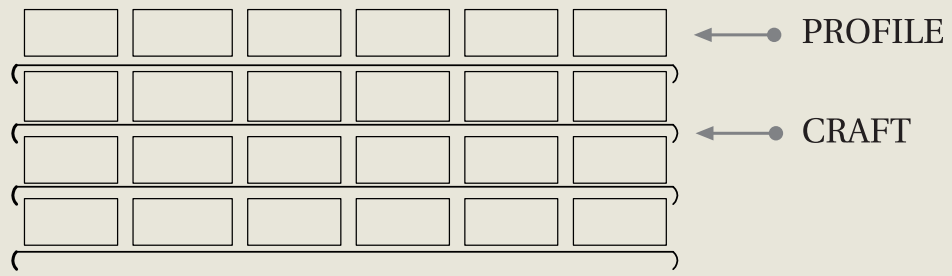
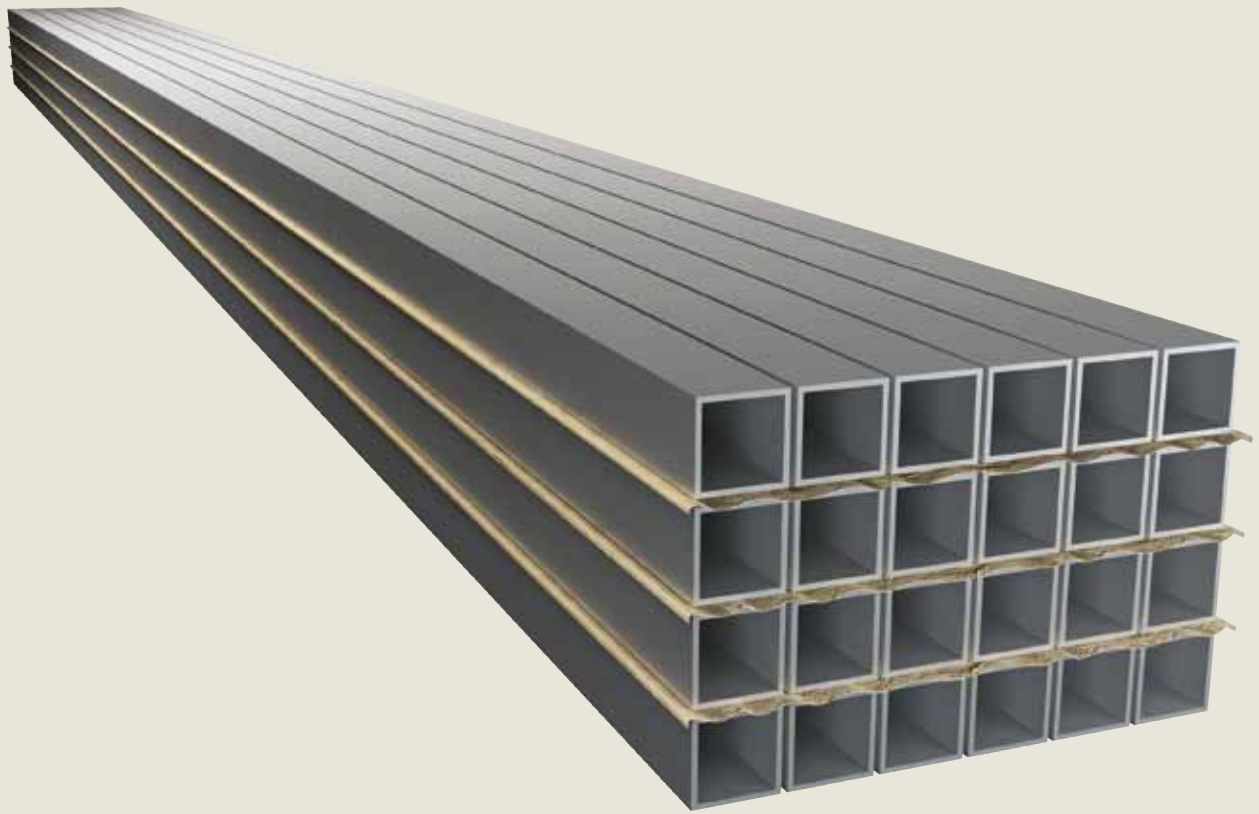



**SEP-3**

**CARDBOARD OR WOOD STRIPS**

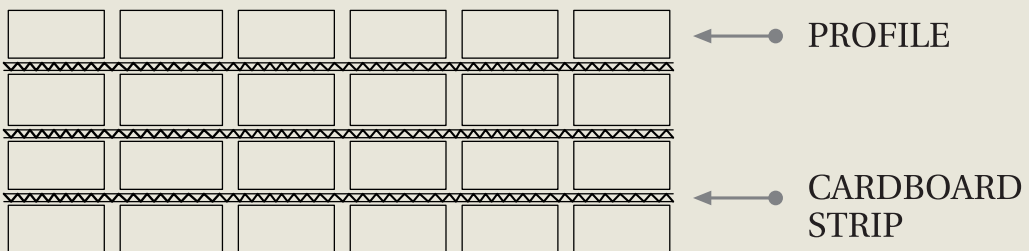
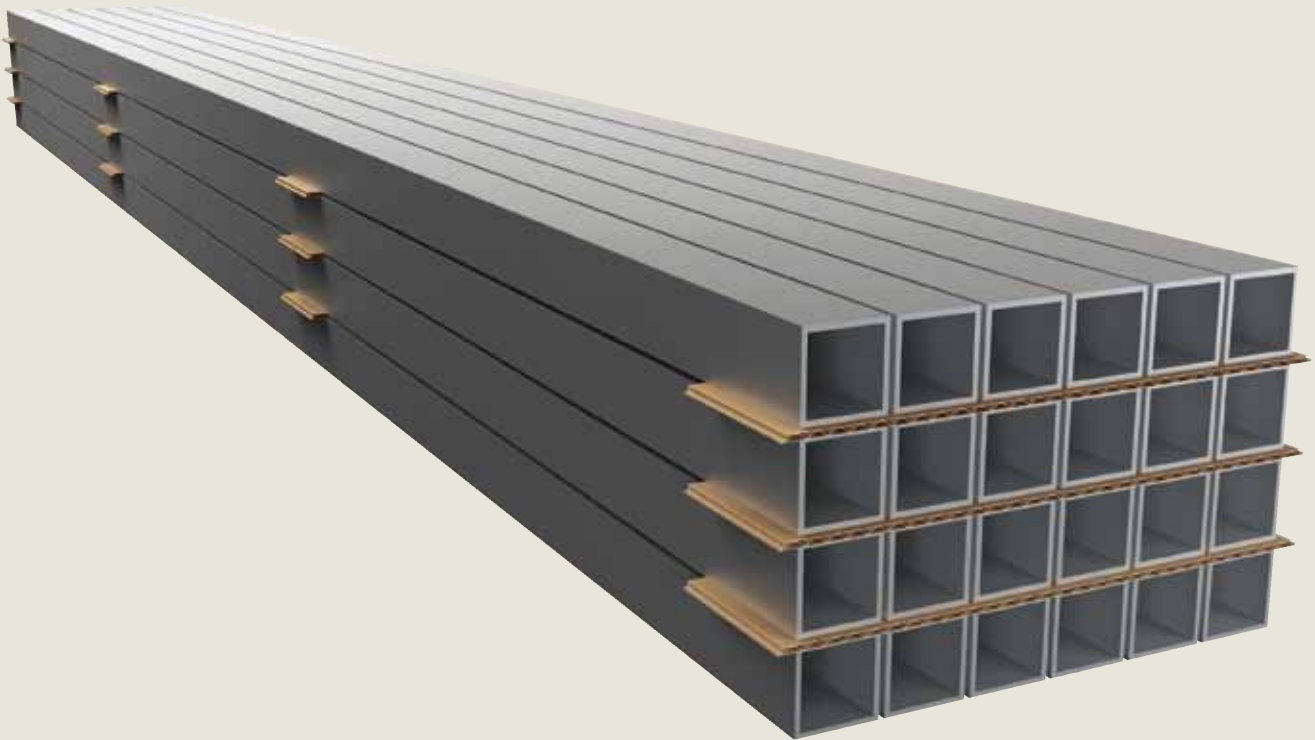



**SEP-4**

**TISSUE INTERLEAVING**  
*(PAPER / NYLON)*

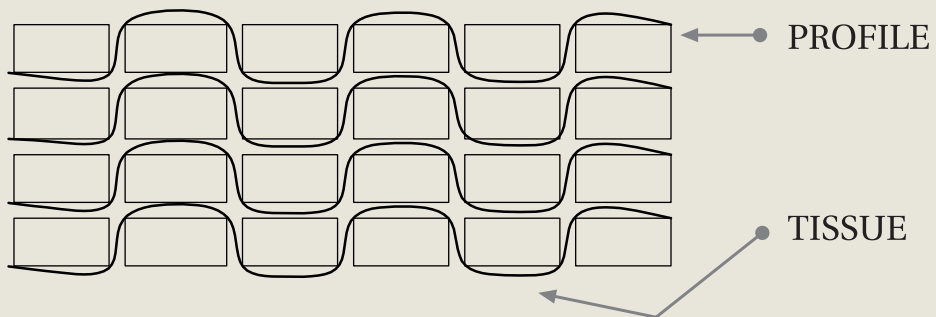
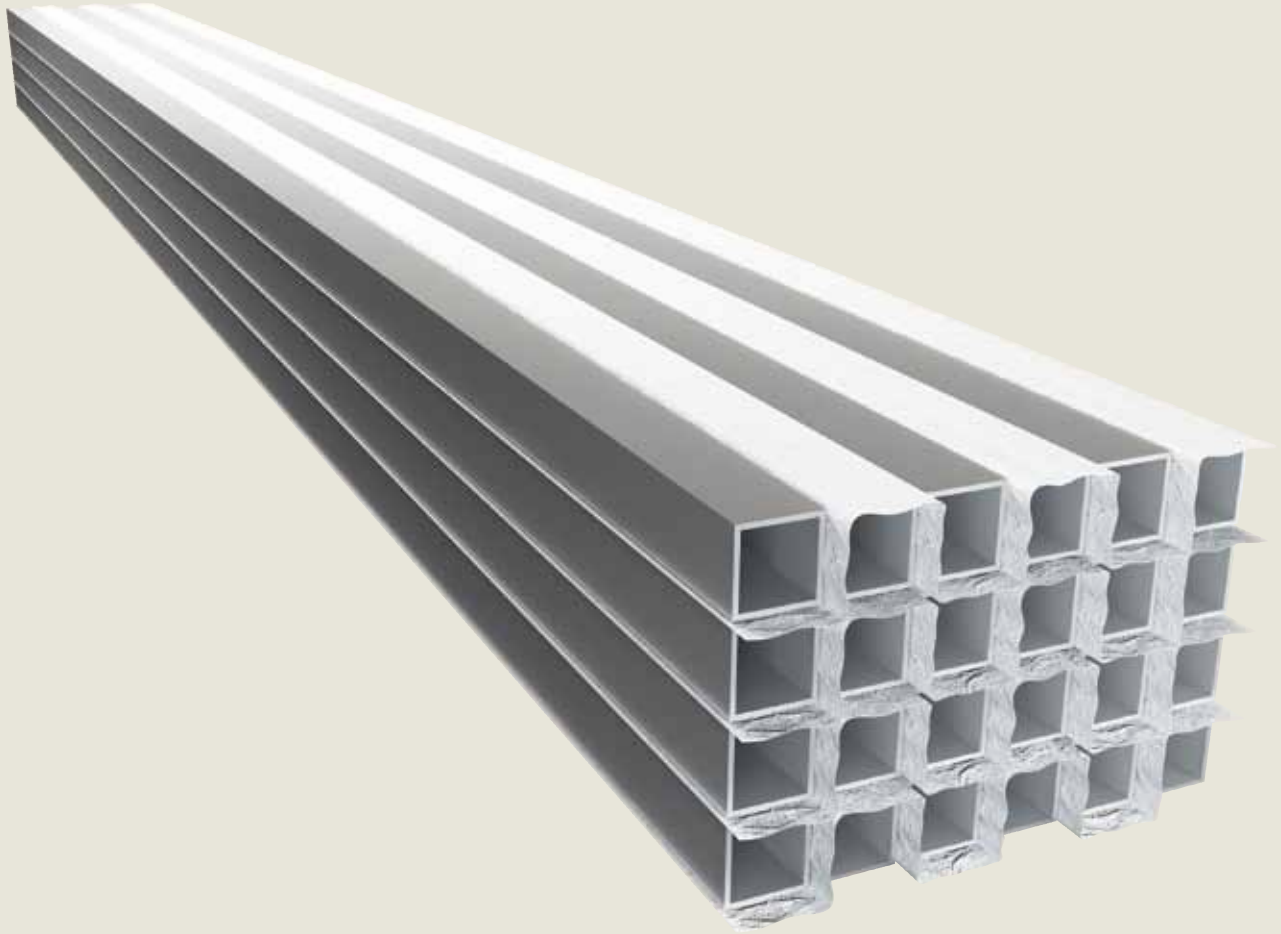



**SEP-5**

**TISSUE INTERLEAVING AND LAYER**  
**(PAPER / NYLON)**

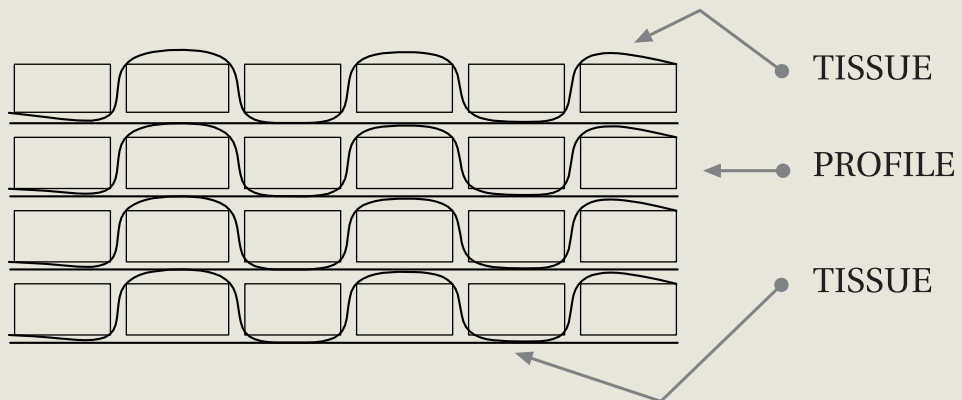
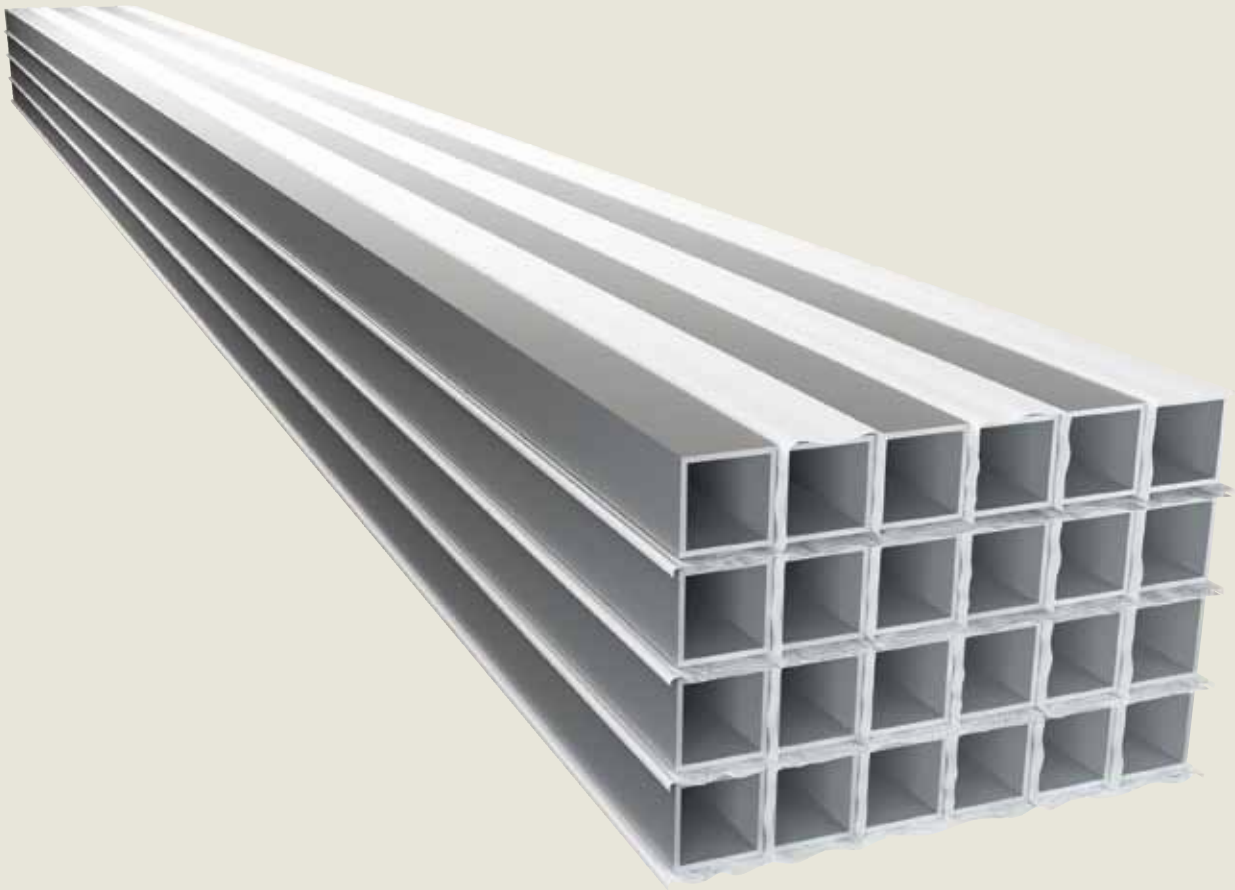



## PAC-1

### NYLON WRAPPING

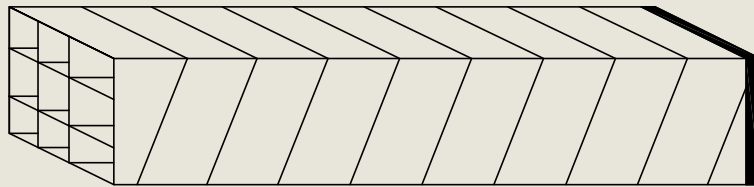
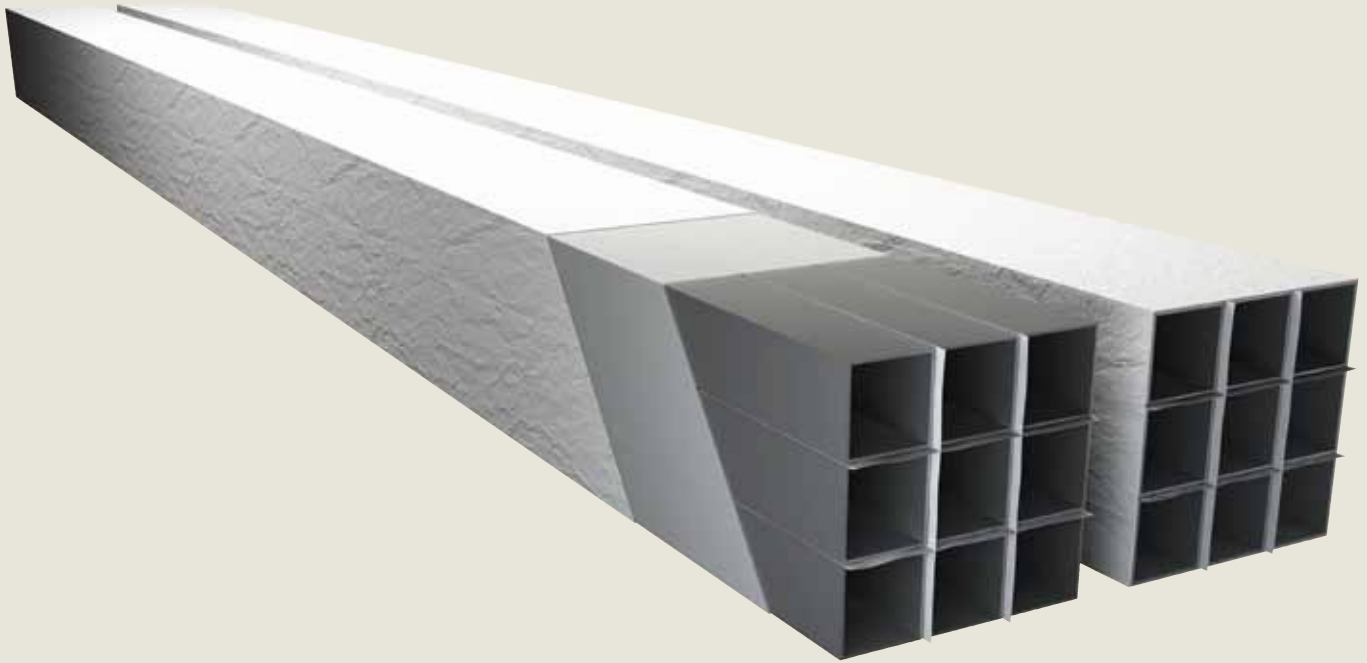

DIMENSION	MIN.	MAX.
LENGTH (m)	2	9
WEIGHT (kg)	10	60
DU (cm)	50	290



## PAC-2

### CREPE PAPER WRAPPING

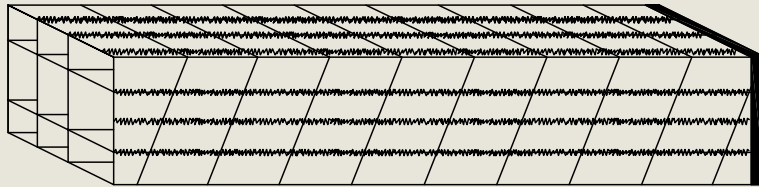
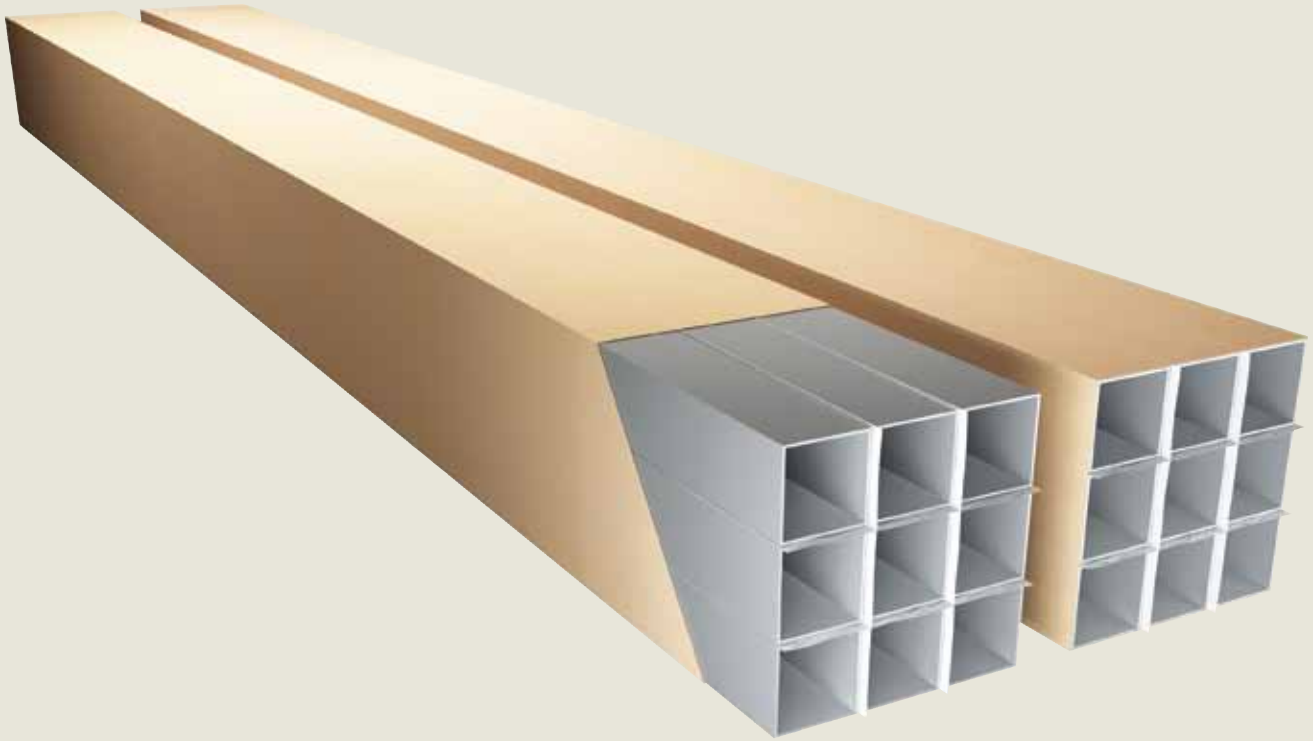

DIMENSION	MIN.	MAX.
LENGTH (m)	2	9
WEIGHT (kg)	10	60
DU (cm)	50	290



## PAC-3

### TAPE STRIPS

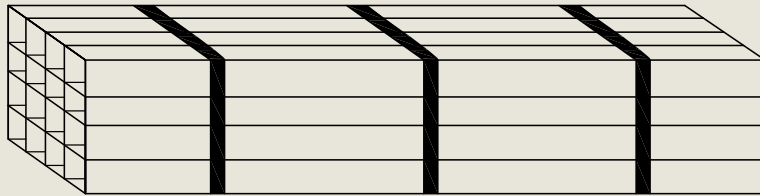
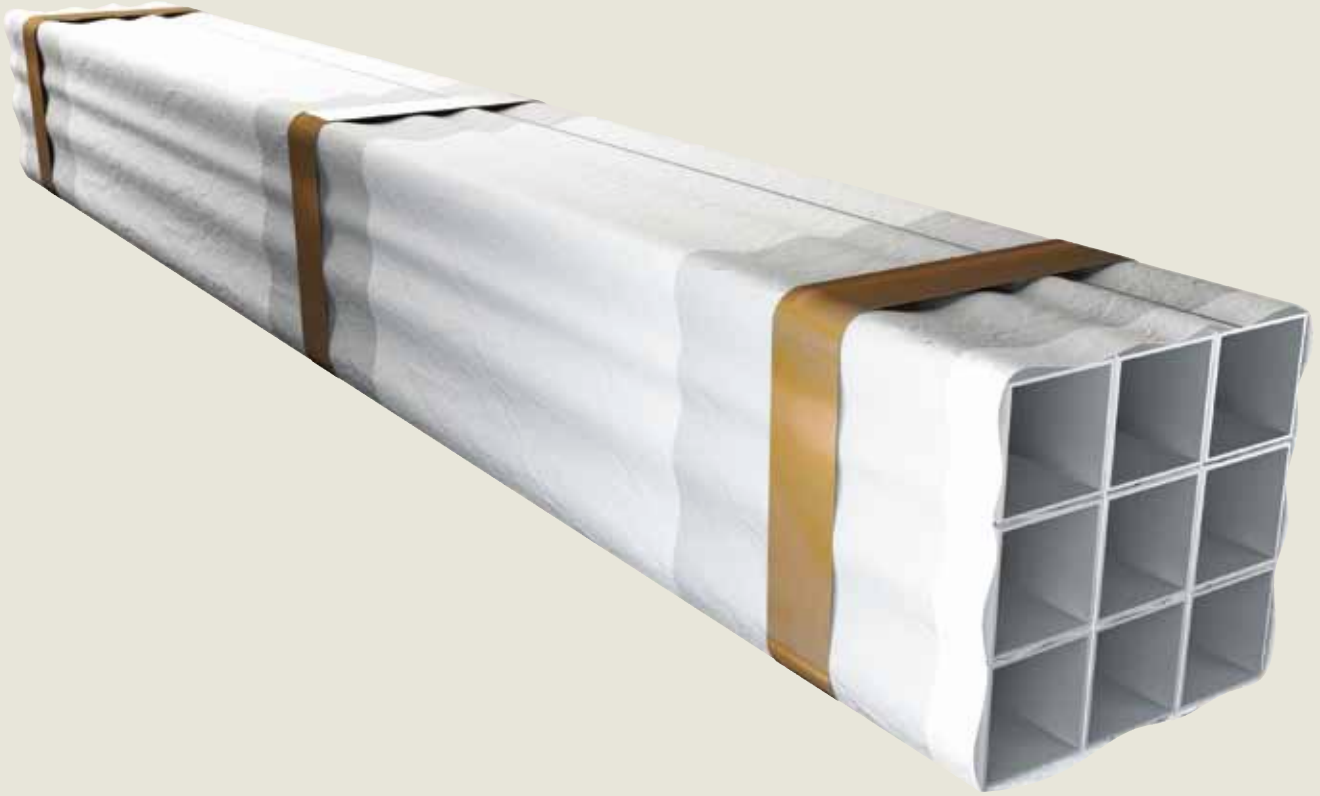

DIMENSION	MIN.	MAX.
LENGTH (m)	2	9
WEIGHT (kg)	10	60
DU (cm)	50	290



## PAC-4

### CARDBOARD TUBE



DIMENSION	MIN.	MAX.
LENGTH (m)	2	3
WEIGHT (kg)	10	60
DU (cm)	60	120



## PAC-5

### CARDBOARD FOLDING

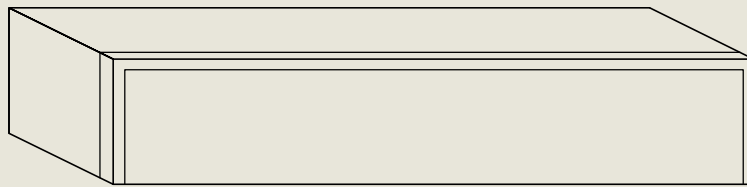

DIMENSION	MIN.	MAX.
LENGTH (m)	2	9
WEIGHT (kg)	10	60
DU (cm)	150	290



## PAC-6

### STRETCH PACK

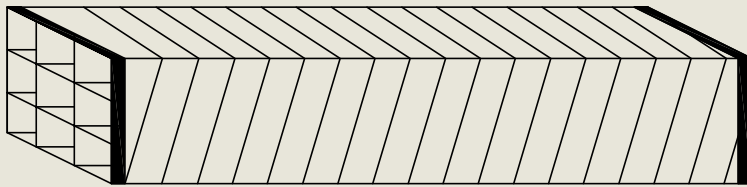
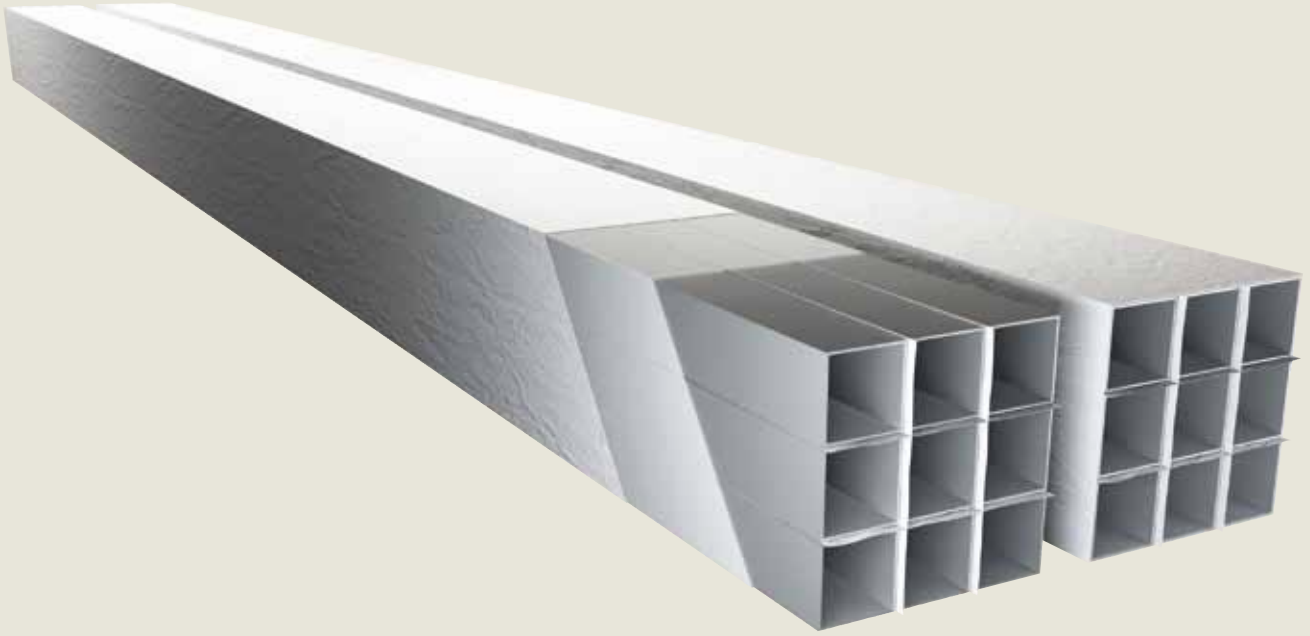

DIMENSION	MIN.	MAX.
LENGTH (m)	2	9
WEIGHT (kg)	10	60
DU (cm)	50	290





## PAL-1

### CARDBOARD SEMI PLATFORM

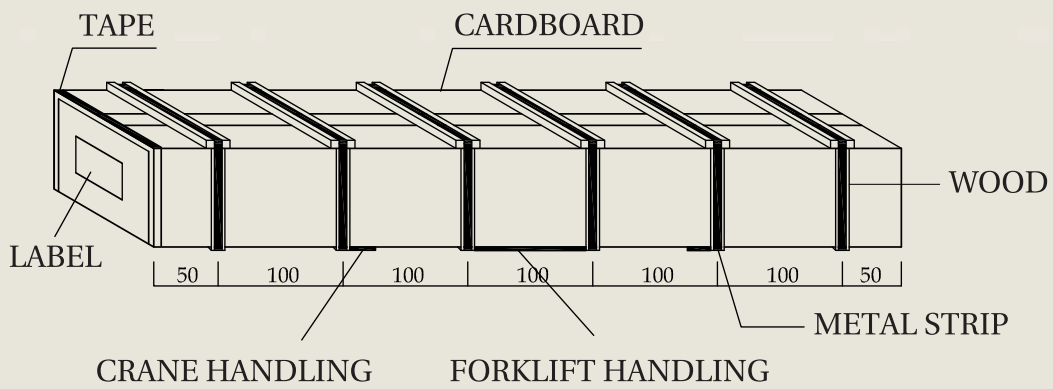

DIMENSION	MIN.	MAX.
LENGTH (m)	2	9
WEIGHT (kg)	150	600
DU (cm)	40	100
WIDTH (cm)	30	80
HEIGHT (cm)	30	60



## PAL-2

### CARDBOARD FULL PLATFORM

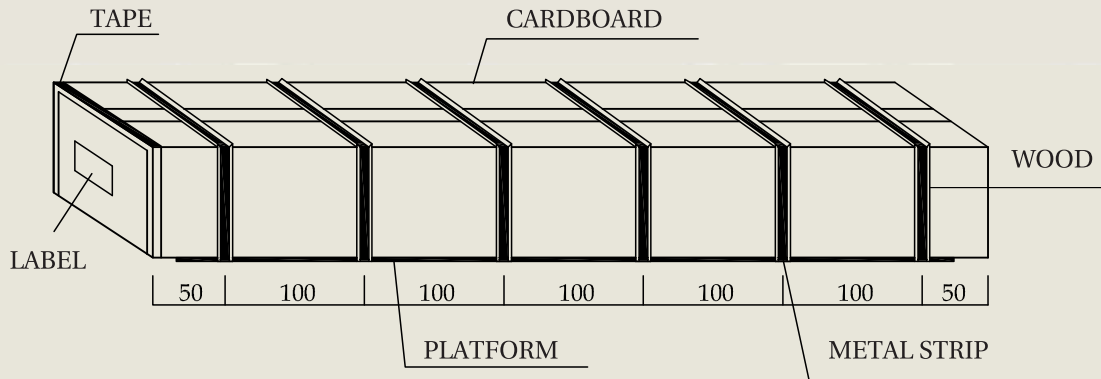

DIMENSION	MIN.	MAX.
LENGTH (m)	2	9
WEIGHT (kg)	150	600
DU (cm)	40	100
WIDTH (cm)	30	80
HEIGHT (cm)	30	60



## PAL-3

### BARE SEMI PLATFORM

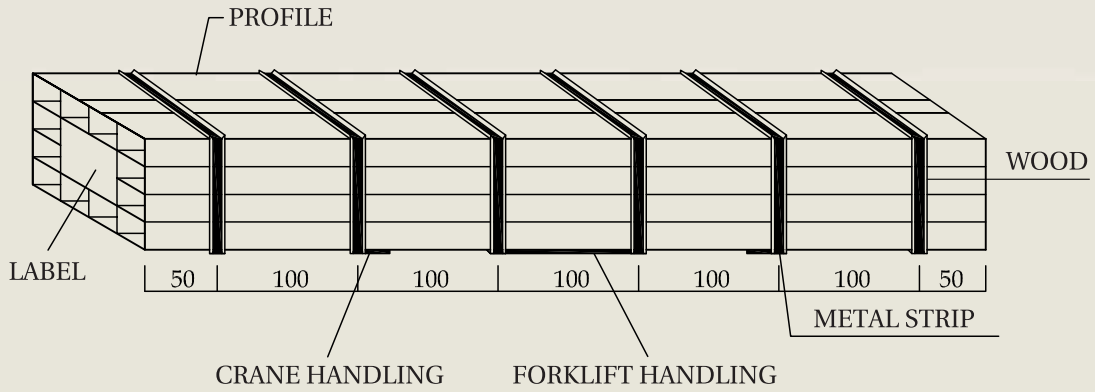
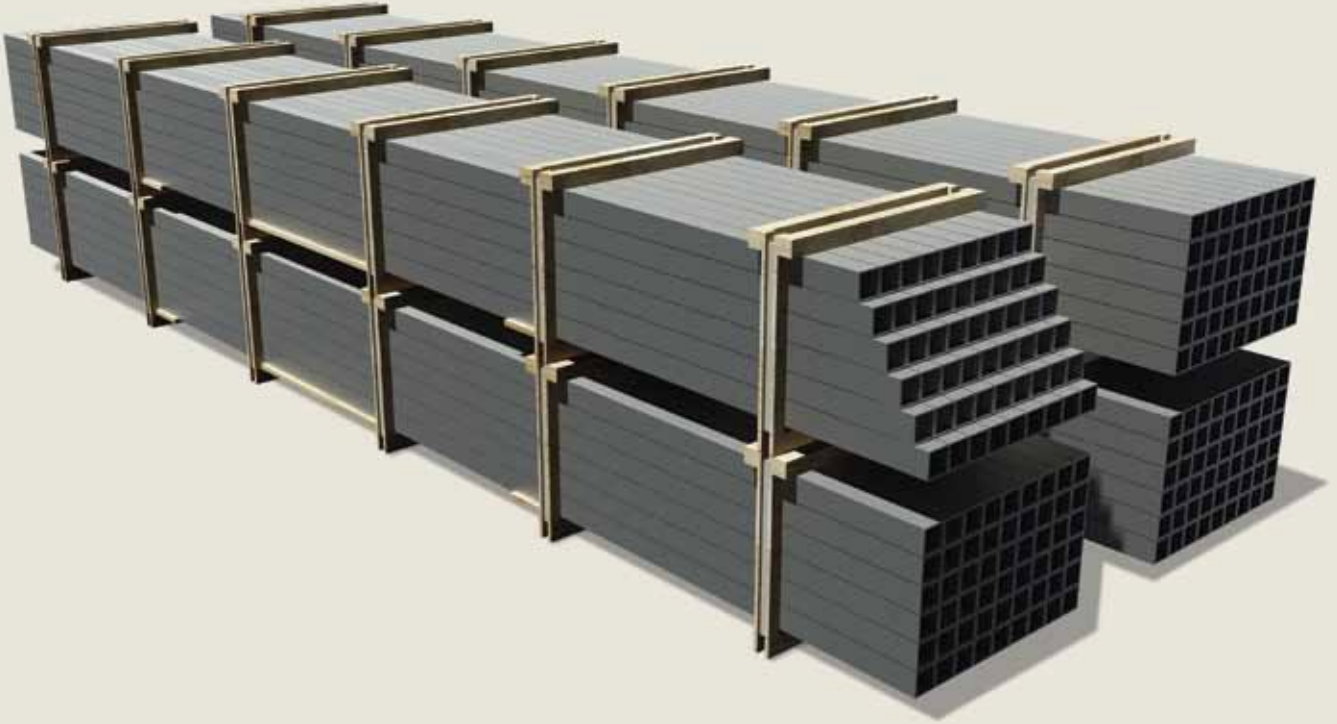

DIMENSION	MIN.	MAX.
LENGTH (m)	2	9
WEIGHT (kg)	150	600
DU (cm)	40	100
WIDTH (cm)	30	80
HEIGHT (cm)	30	60



## PAL-4

### BARE FULL PLATFORM

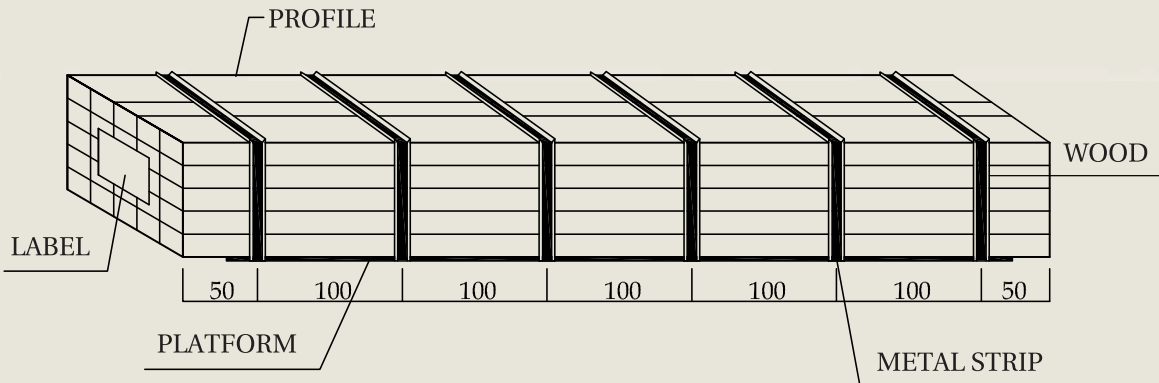
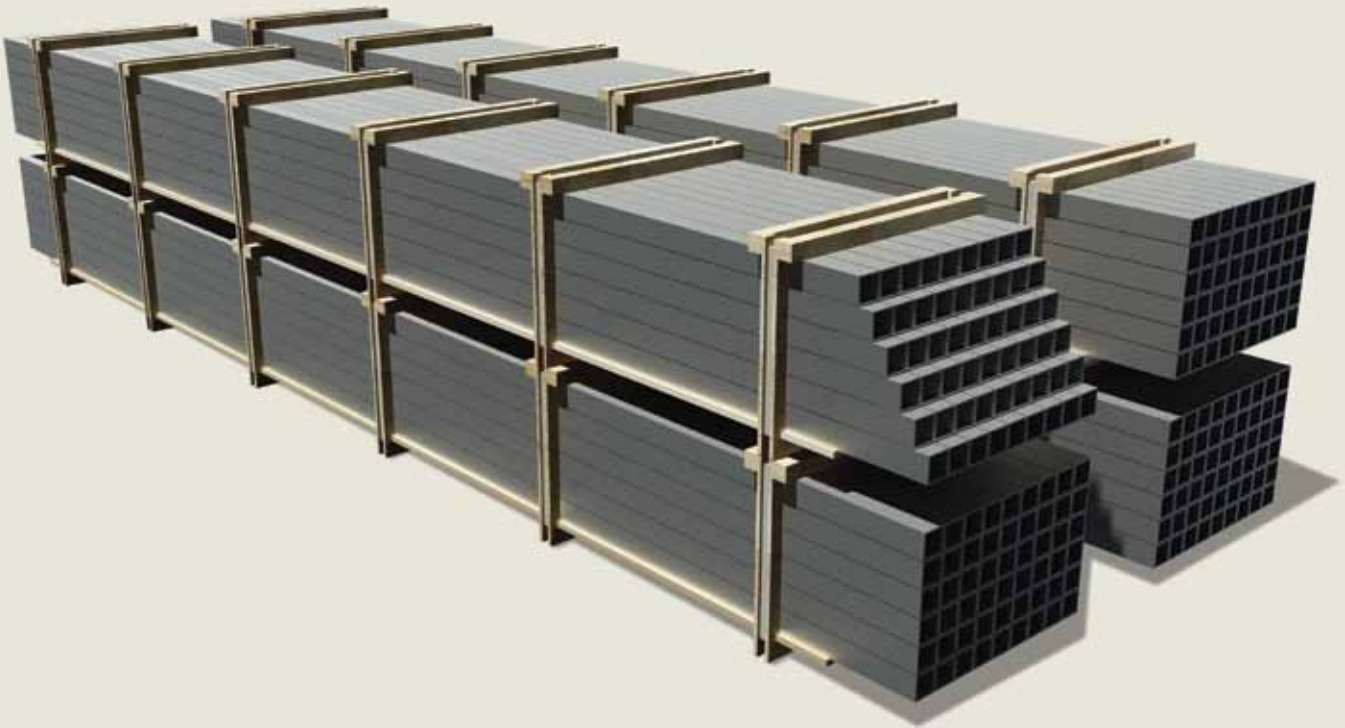

DIMENSION	MIN.	MAX.
LENGTH (m)	2	9
WEIGHT (kg)	150	600
DU (cm)	40	100
WIDTH (cm)	30	80
HEIGHT (cm)	30	60



## PAL-5

### EURO PALLET

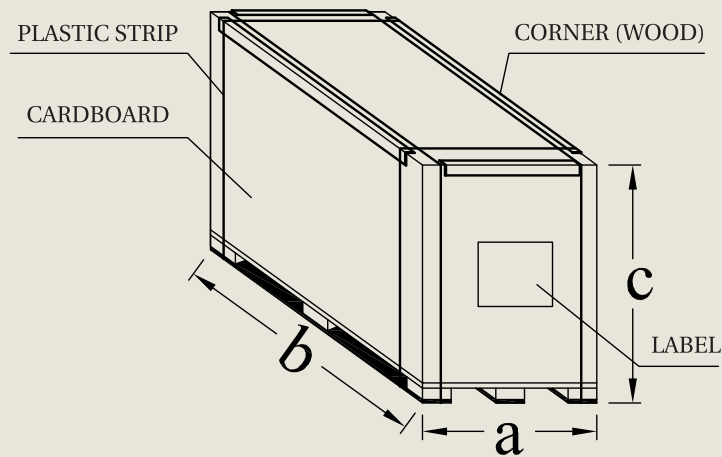

DIMENSION	MIN.	MAX.
a (cm)	80	100
b (cm)	100	120
c (cm)	100	150
WEIGHT (kg)	150	600



## PAL-6

### CARDBOARD FOLDING WITH STRIPS

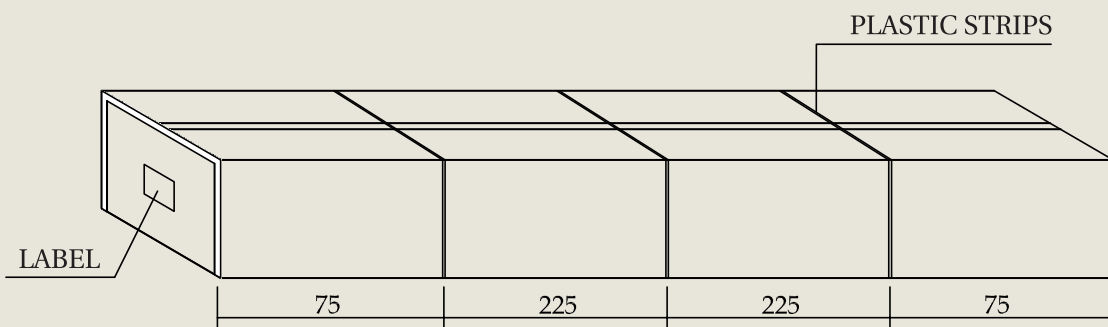
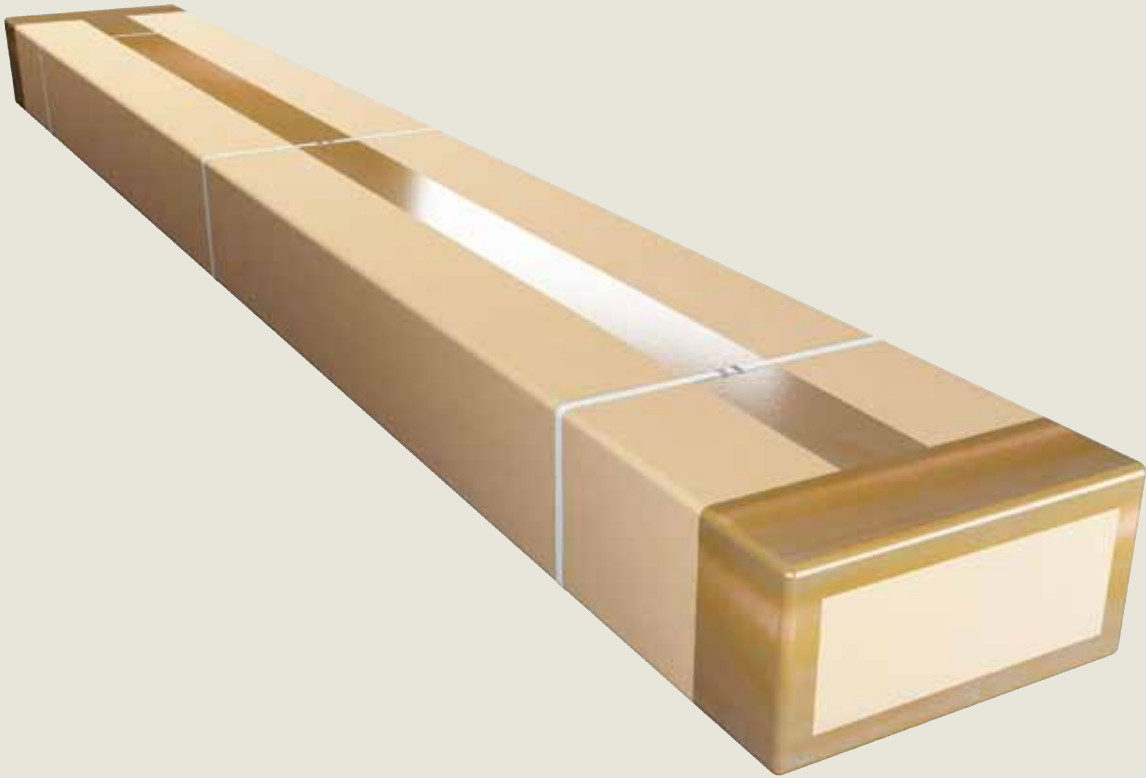

DIMENSION	MIN.	MAX.
LENGTH (m)	2	9
WEIGHT (kg)	30	80
DU (cm)	40	100
WIDTH (cm)	30	80
HEIGHT (cm)	30	60



## PAL-7

### WOODEN CRATE

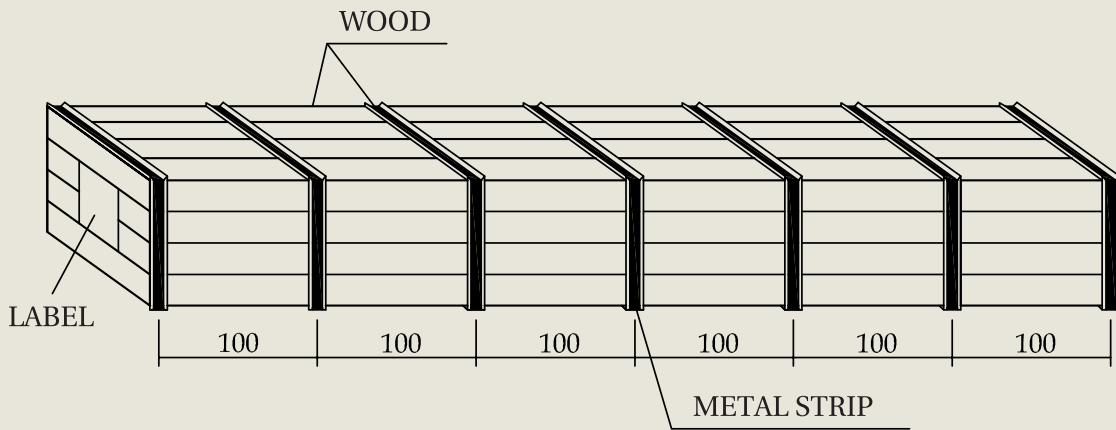

DIMENSION	MIN.	MAX.
LENGTH (m)	2	7
WEIGHT (kg)	150	600
DU (cm)	40	100
WIDTH (cm)	30	80
HEIGHT (cm)	30	60



## PAL-8

### WOODEN CAGE

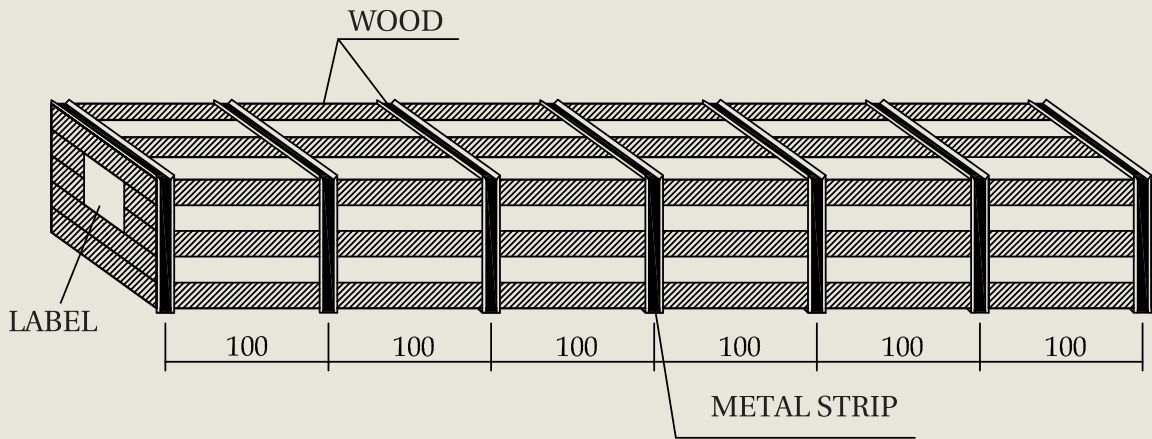

DIMENSION	MIN.	MAX.
LENGTH (m)	2	7
WEIGHT (kg)	150	600
DU (cm)	40	100
WIDTH (cm)	30	80
HEIGHT (cm)	30	60





*Burak Aluminium is committed  
to provide a greener service.*





[www.burak.com.tr](http://www.burak.com.tr)

**BURAK ALUMİNYUM A.Ş.**

**Lüleburgaz Factory**

Uğurlu Dere Mevkii Muratlı Yolu 3.km  
Lüleburgaz, 39780 Kırklareli / Türkiye

Tel : +90 444 37 40

Fax: +90 (288) 436 13 63